



US00D374080S

**United States Patent** [19]  
**Broberg**

[11] **Patent Number: Des. 374,080**

[45] **Date of Patent: \*\*Sep. 24, 1996**

[54] **ABUTMENT FOR A DENTAL IMPLANT**

[75] Inventor: **Leif Broberg**, Gothenburg, Sweden

[73] Assignee: **Astra Aktiebolag**, Sodertalje, Sweden

[\*\*] Term: **14 Years**

[21] Appl. No.: **41,389**

[22] Filed: **Jul. 12, 1995**

[30] **Foreign Application Priority Data**

Jan. 12, 1995	[SE]	Sweden	.....	95-0070
Jan. 12, 1995	[SE]	Sweden	.....	95-0067
Jan. 12, 1995	[SE]	Sweden	.....	95-0074
Jan. 12, 1995	[SE]	Sweden	.....	95-0075

[52] **U.S. Cl.** ..... **D24/156**

[58] **Field of Search** ..... D24/156, 155,  
D24/176; 433/174, 173, 172, 192

[56] **References Cited**

**U.S. PATENT DOCUMENTS**

D. 296,362	6/1988	Branemark	.....	D24/156
D. 353,674	12/1994	Jörn�us	.....	D24/156
5,030,095	7/1991	Niznick	.....	433/173
5,071,350	12/1991	Niznick	.....	433/174
5,169,309	12/1992	Staubli et al.	.....	433/174
5,399,090	3/1995	Padros-Fradera	.....	433/173

*Primary Examiner*—Kay H. Chin  
*Attorney, Agent, or Firm*—White & Case

[57] **CLAIM**

The ornamental design for an abutment for a dental implant, as shown and described.

**DESCRIPTION**

FIG. 1 is a perspective view of an abutment according to the present invention;

FIG. 2 is a bottom view of FIG. 1;

FIG. 3 is a side view of FIG. 1;

FIG. 4 is a top view of FIG. 1;

FIG. 5 is a side view of FIG. 1;

FIG. 6 is a perspective view of a second embodiment of the abutment according to the present invention;

FIG. 7 is a bottom view of FIG. 6;

FIG. 8 is a side view of FIG. 6;

FIG. 9 is a top view of FIG. 6;

FIG. 10 is a side view of FIG. 6;

FIG. 11 is a perspective view of a third embodiment of the abutment according to the present invention;

FIG. 12 is a bottom view of FIG. 11;

FIG. 13 is a side view of FIG. 11;

FIG. 14 is a top view of FIG. 11;

FIG. 15 is a side view of FIG. 11;

FIG. 16 is a perspective view of a fourth embodiment of the abutment according to the present invention;

FIG. 17 is a bottom view of FIG. 16;

FIG. 18 is a side view of FIG. 16;

FIG. 19 is a top view of FIG. 16; and,

FIG. 20 is a side view of FIG. 16.

**1 Claim, 4 Drawing Sheets**

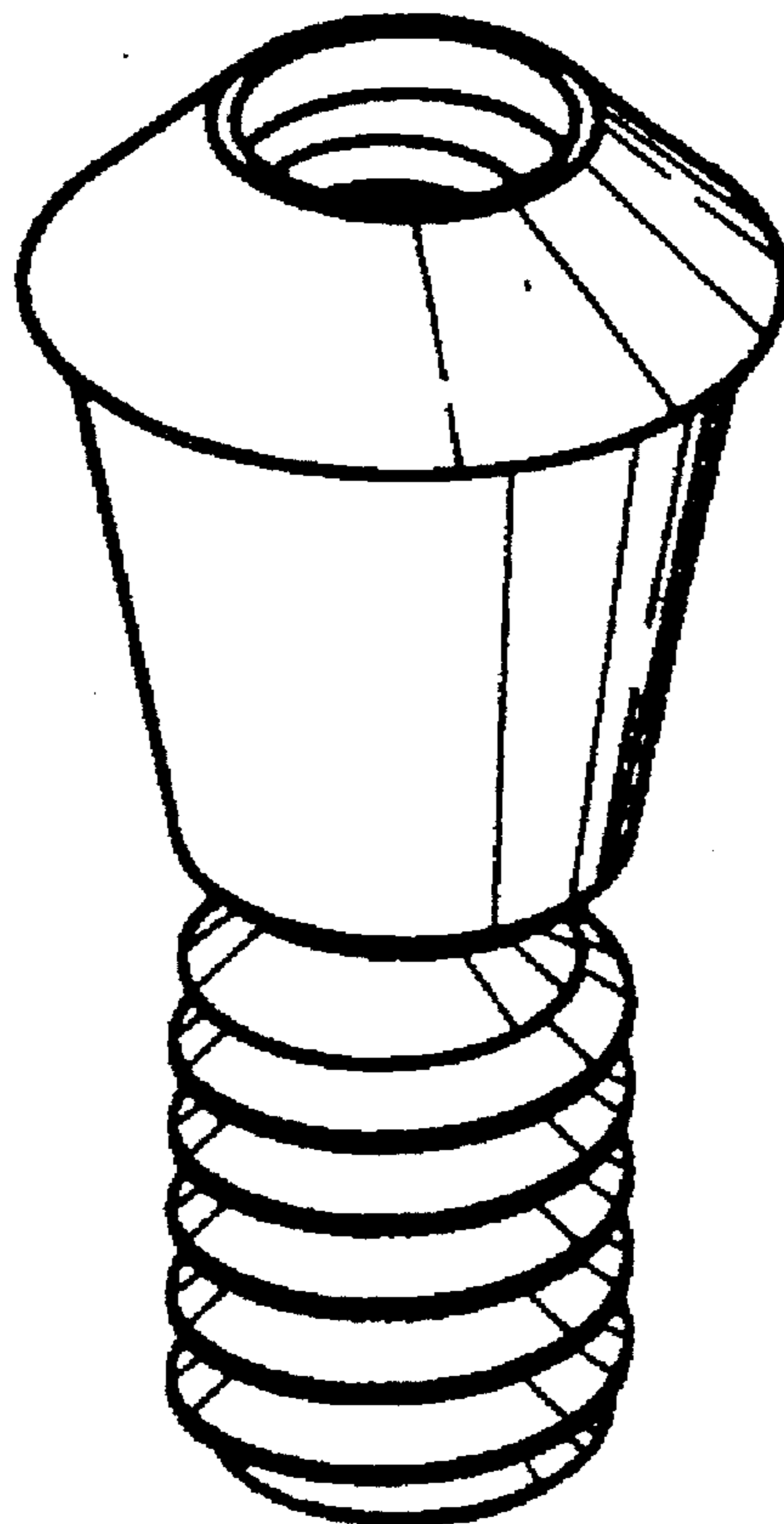

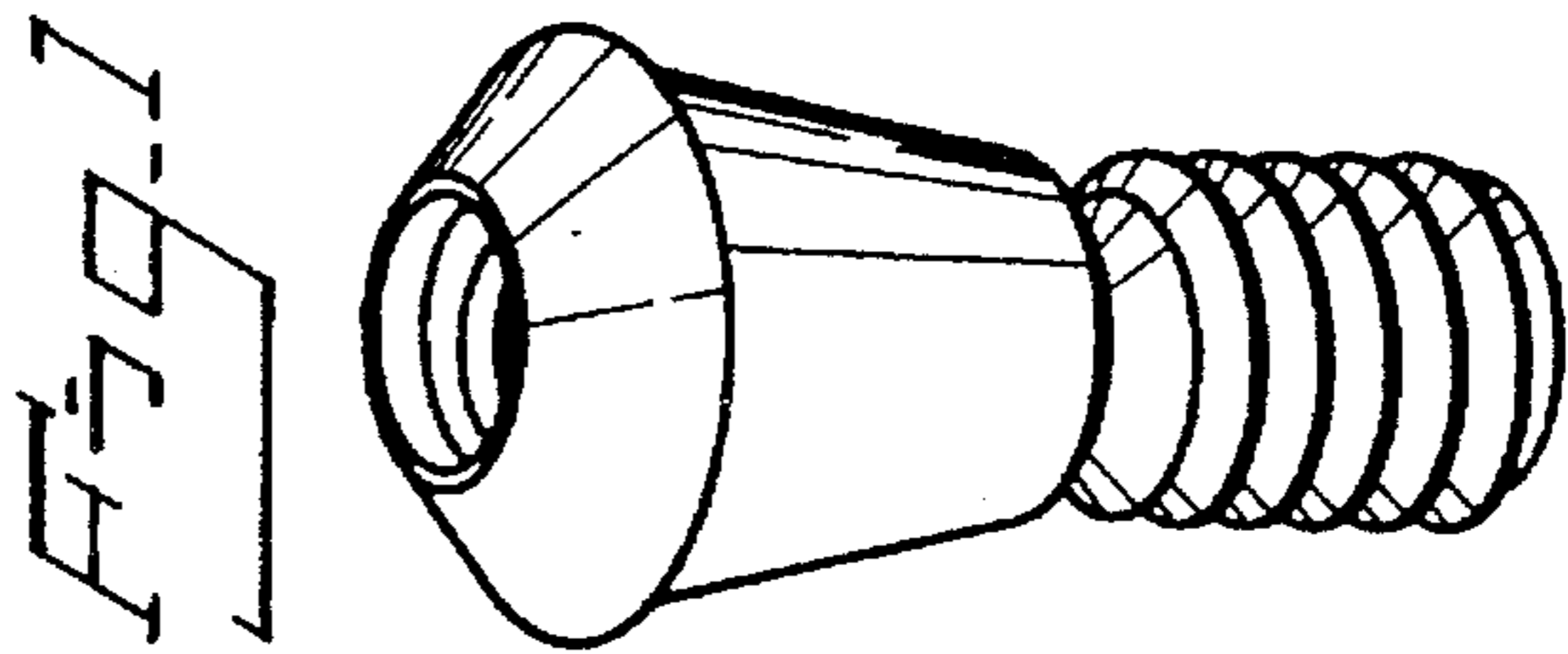
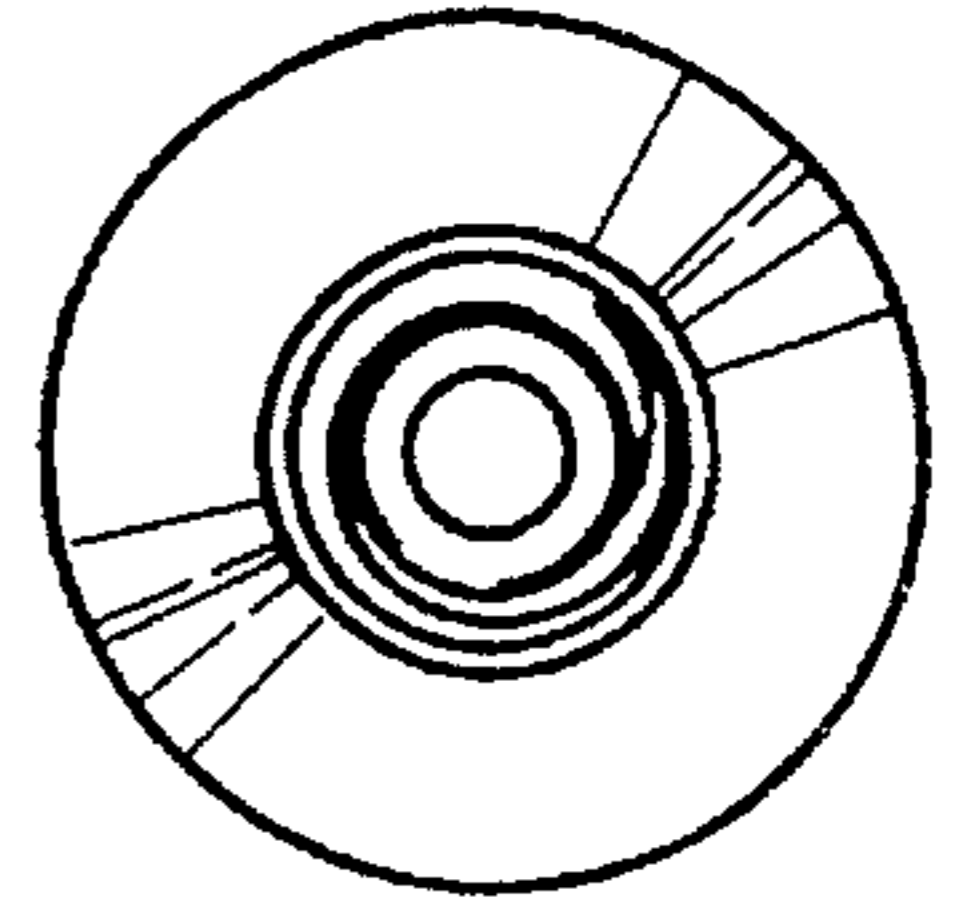
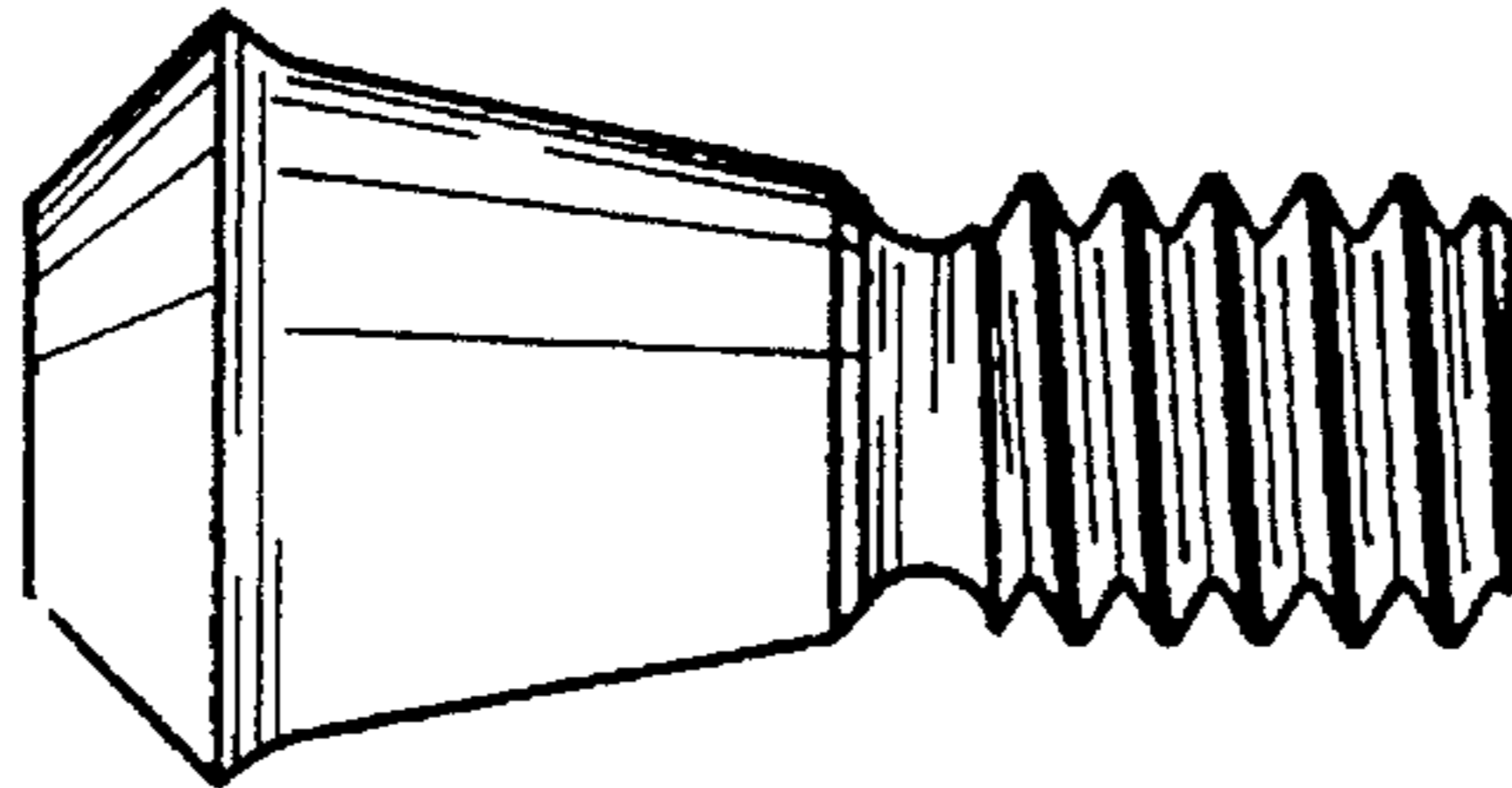
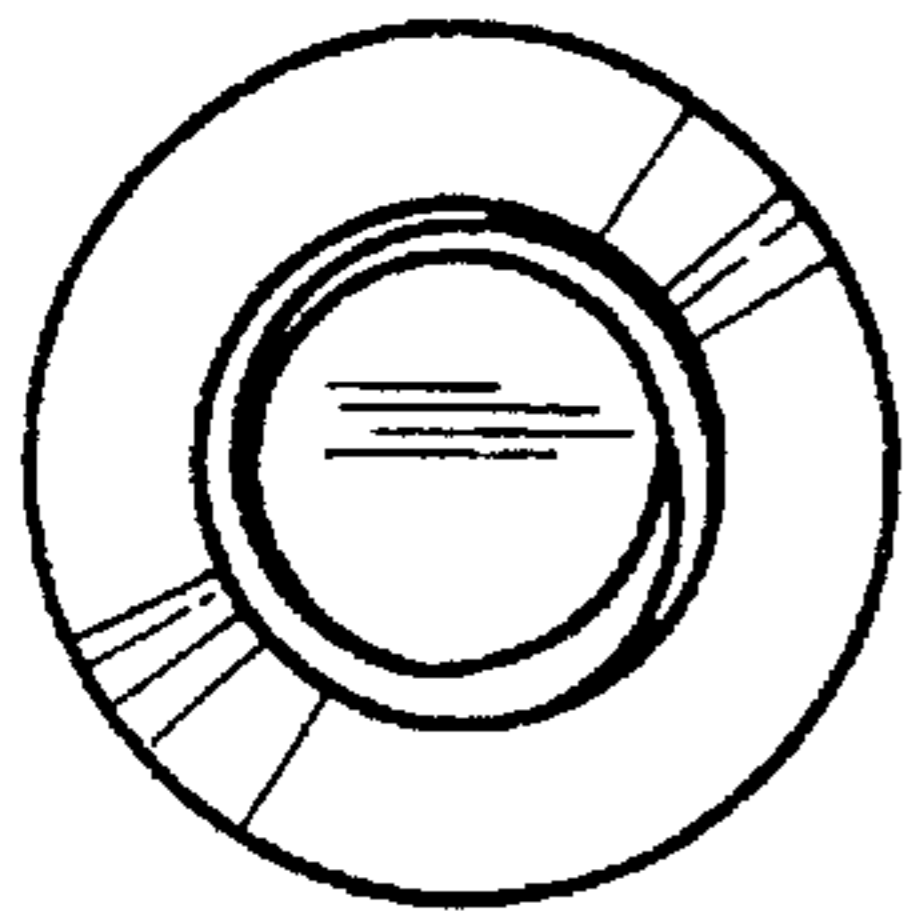
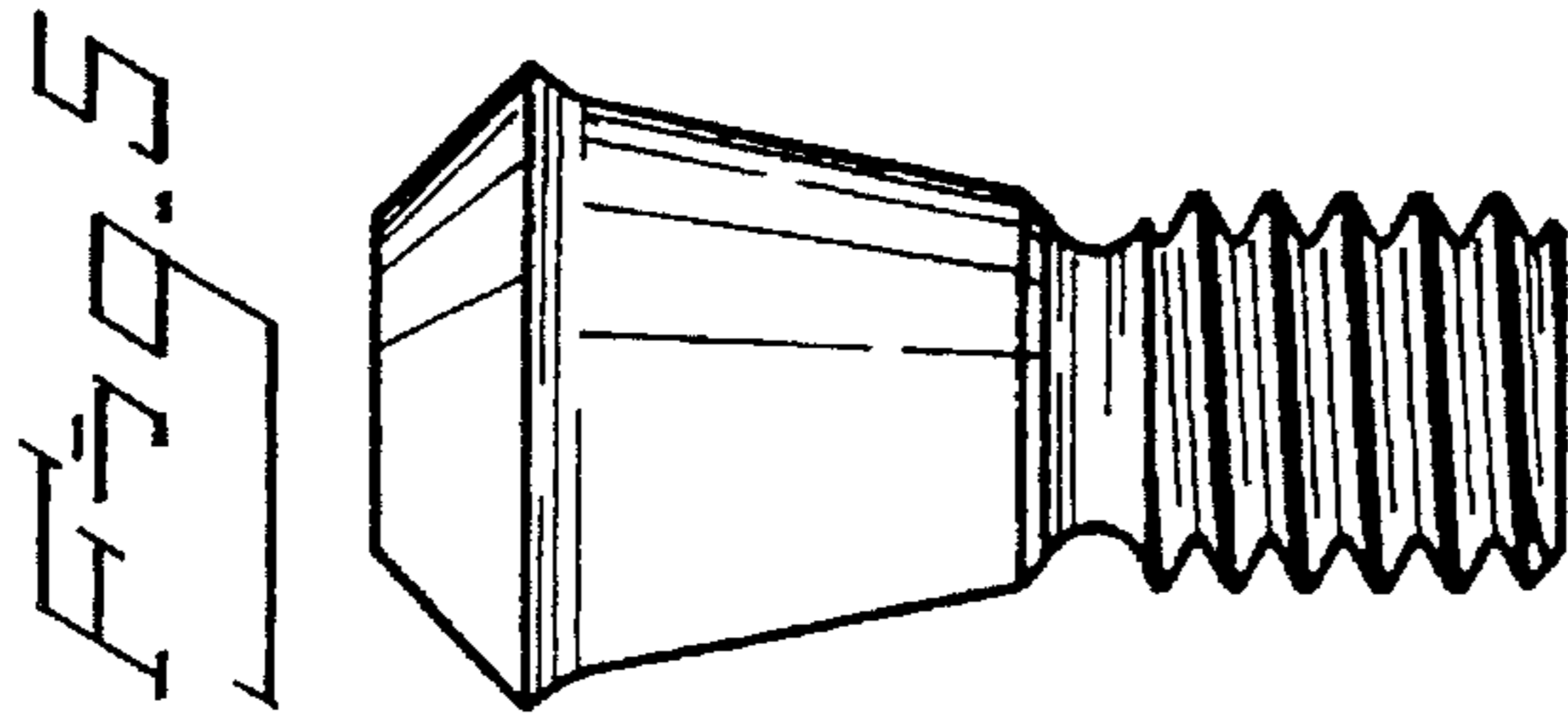

Fig. 10

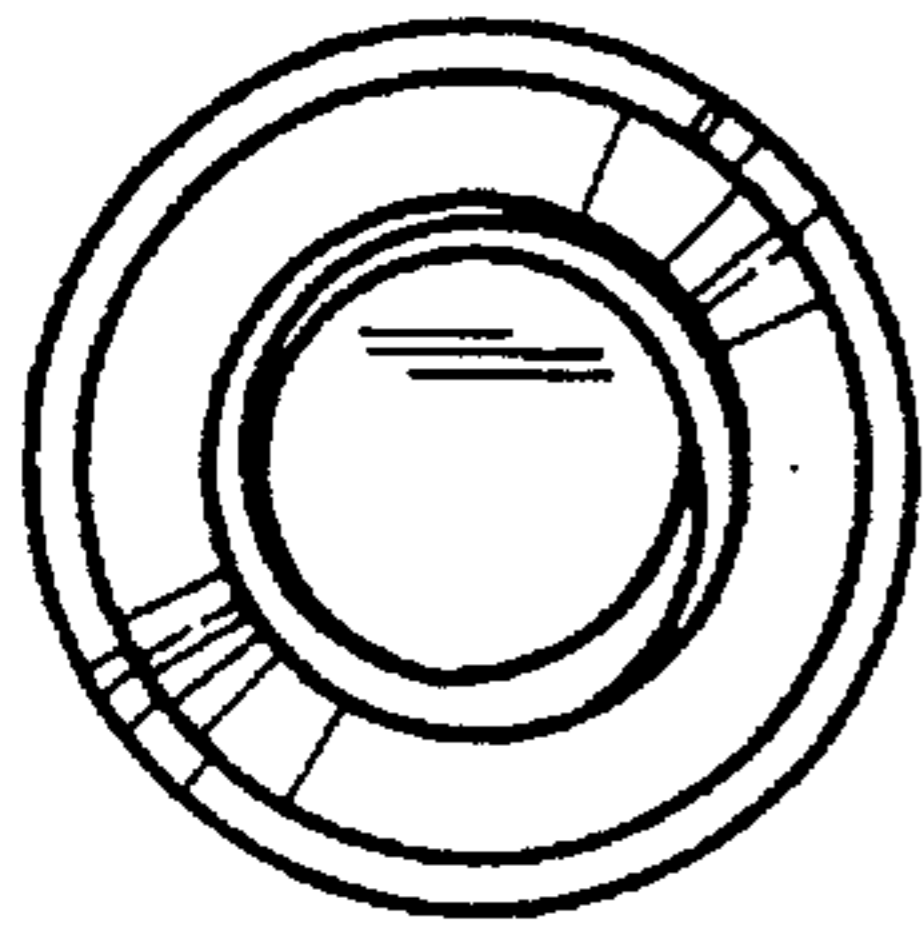
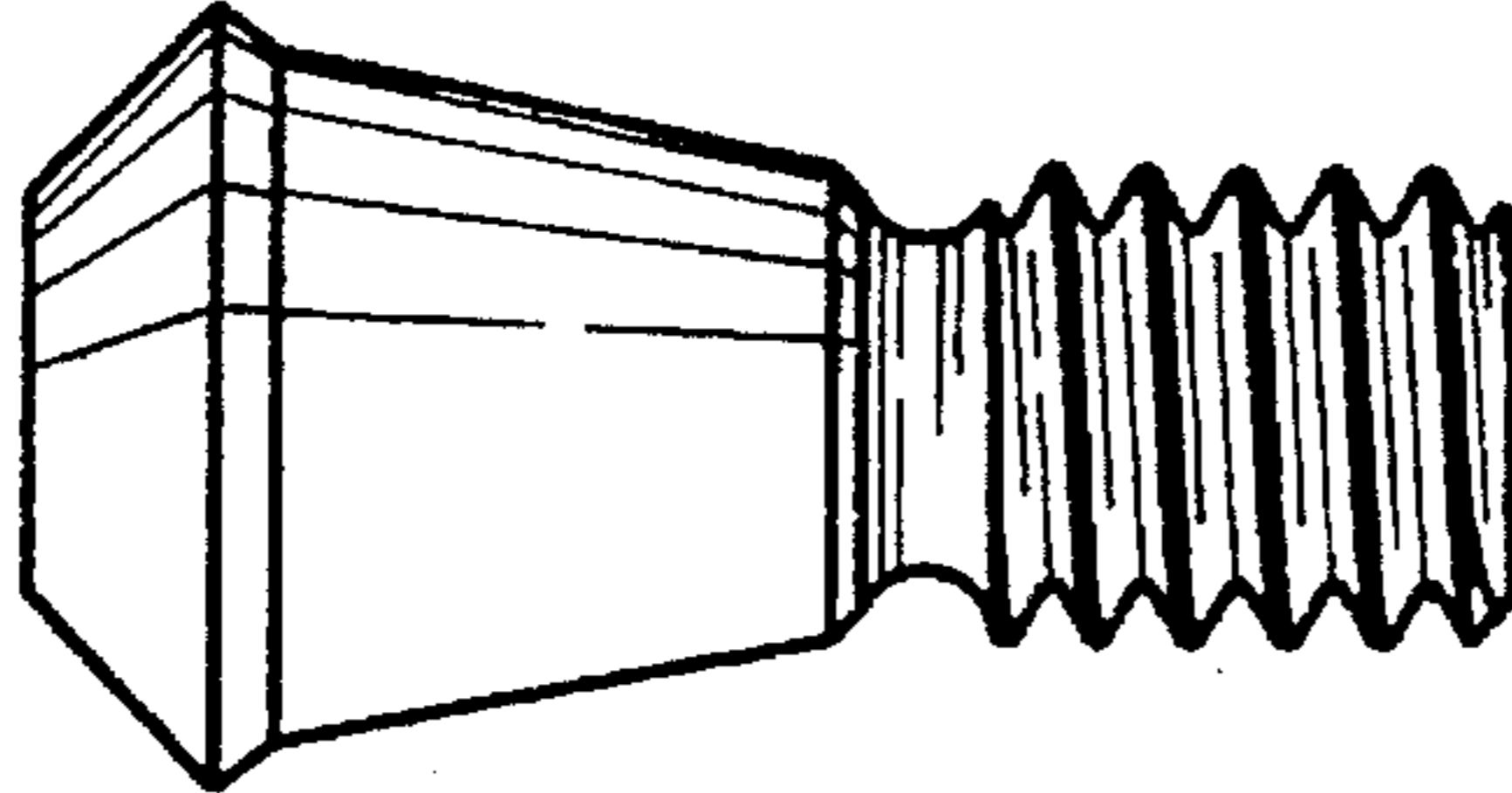

Fig. 7

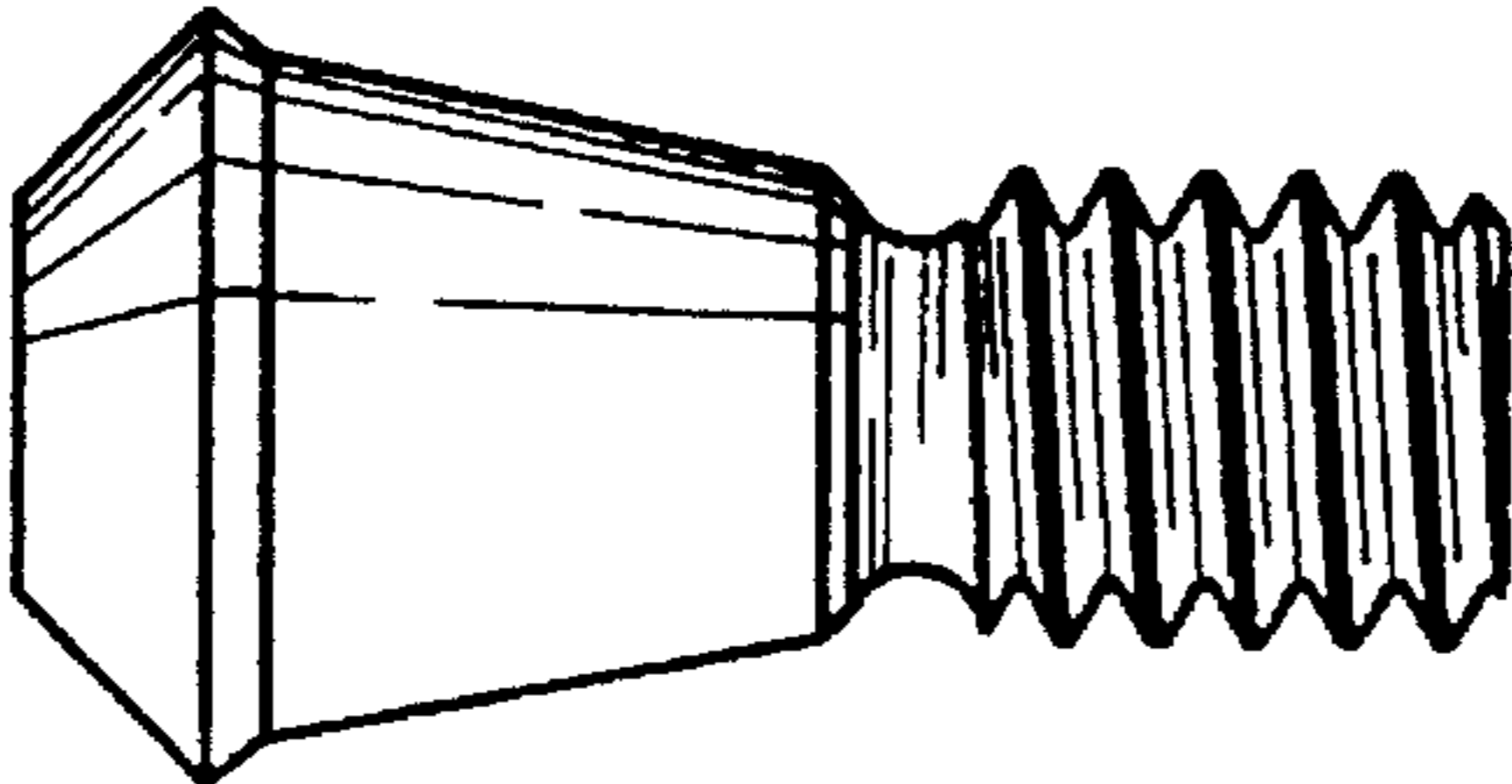

Fig. 8

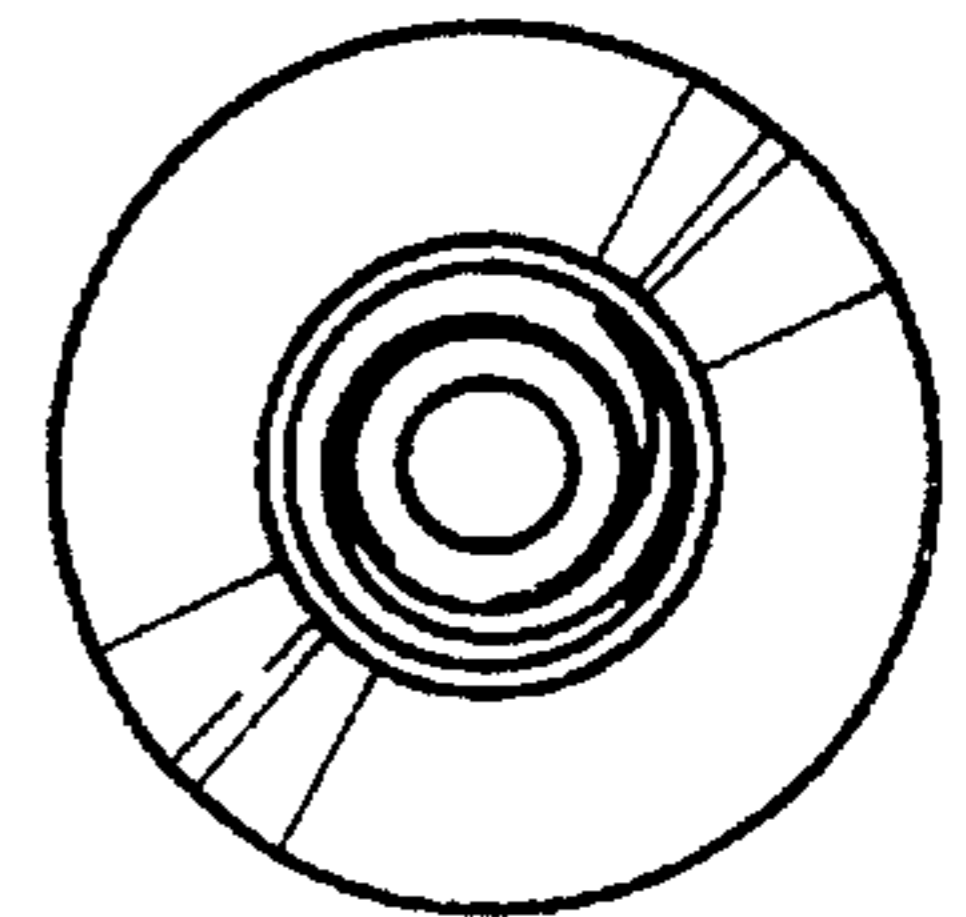

Fig. 9

Fig. 6

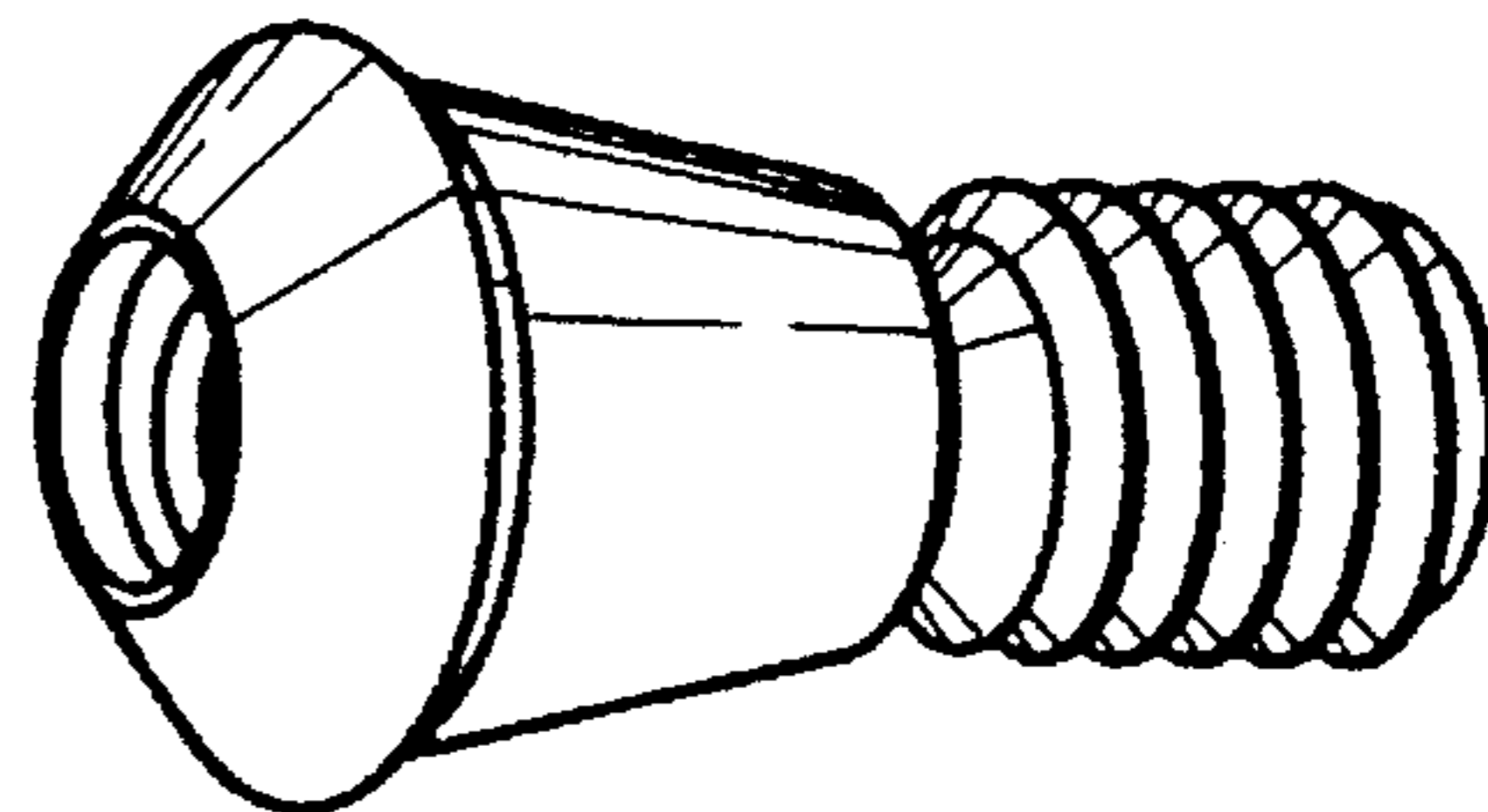

FIG. 15

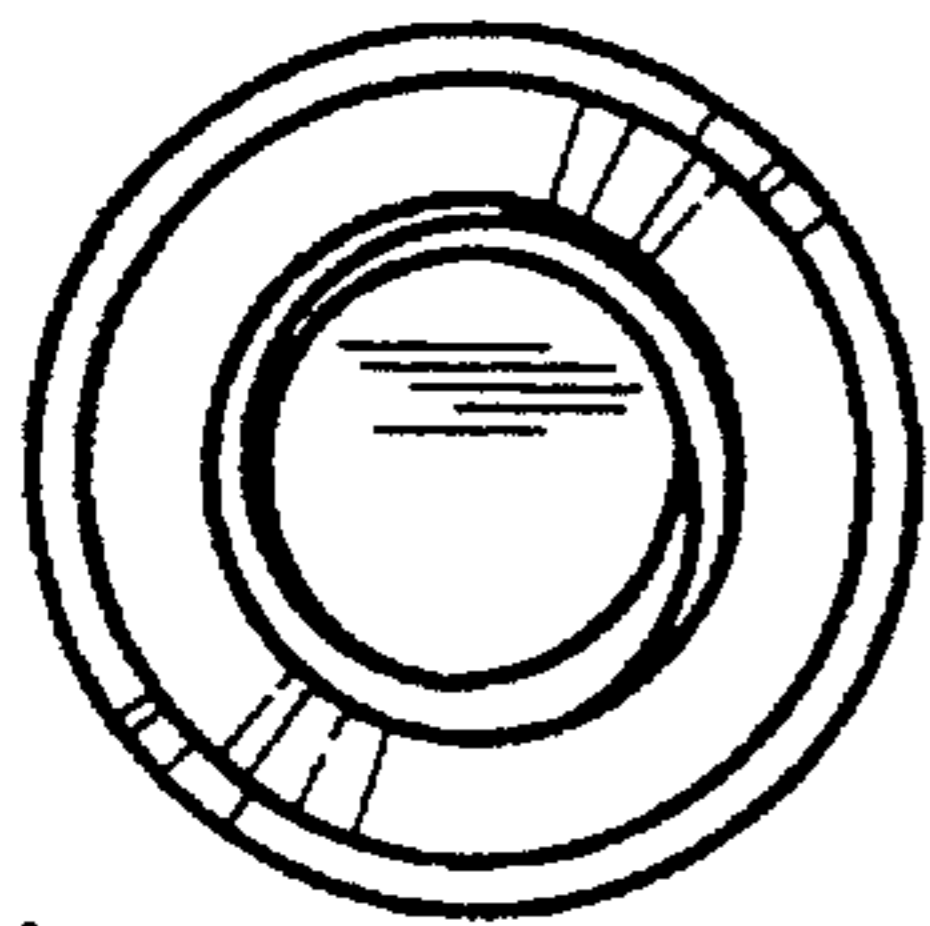
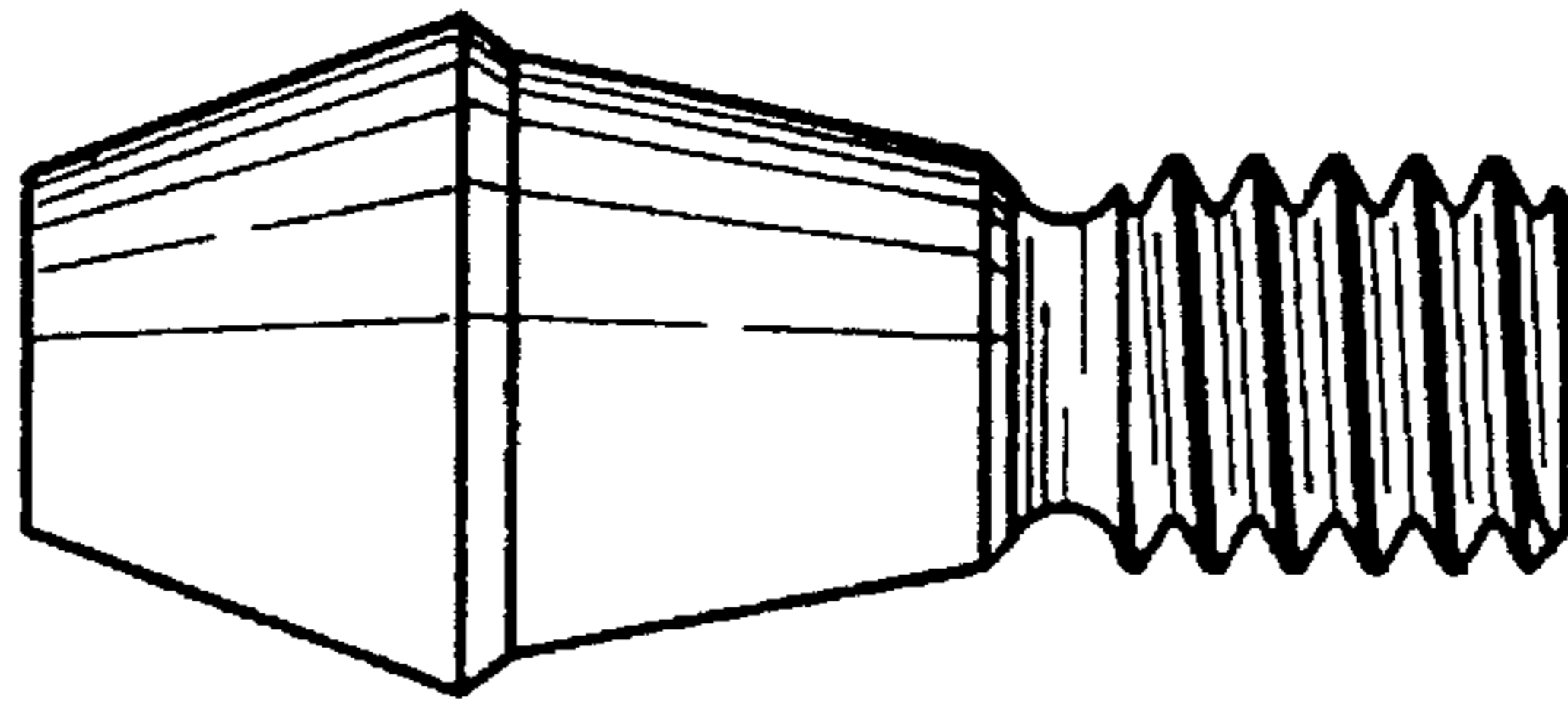

FIG. 12

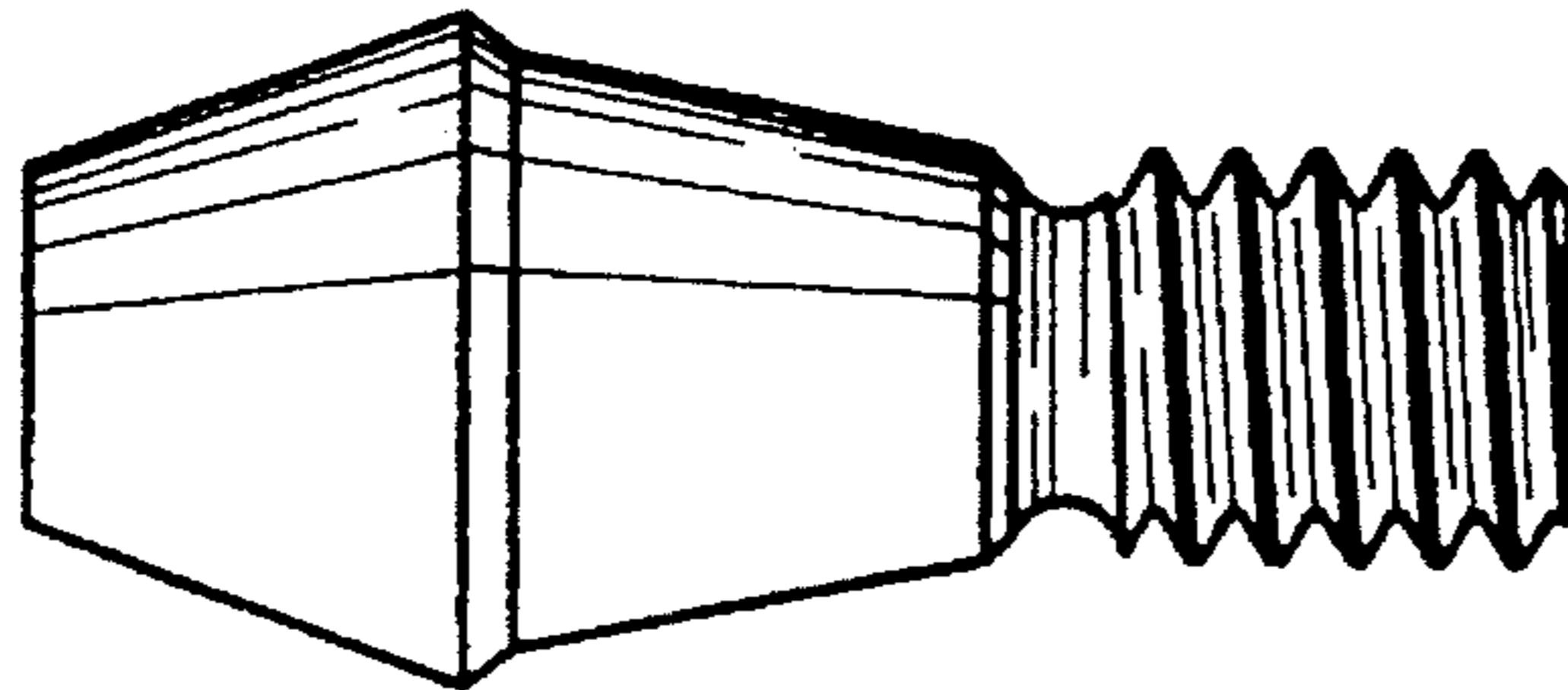

FIG. 13

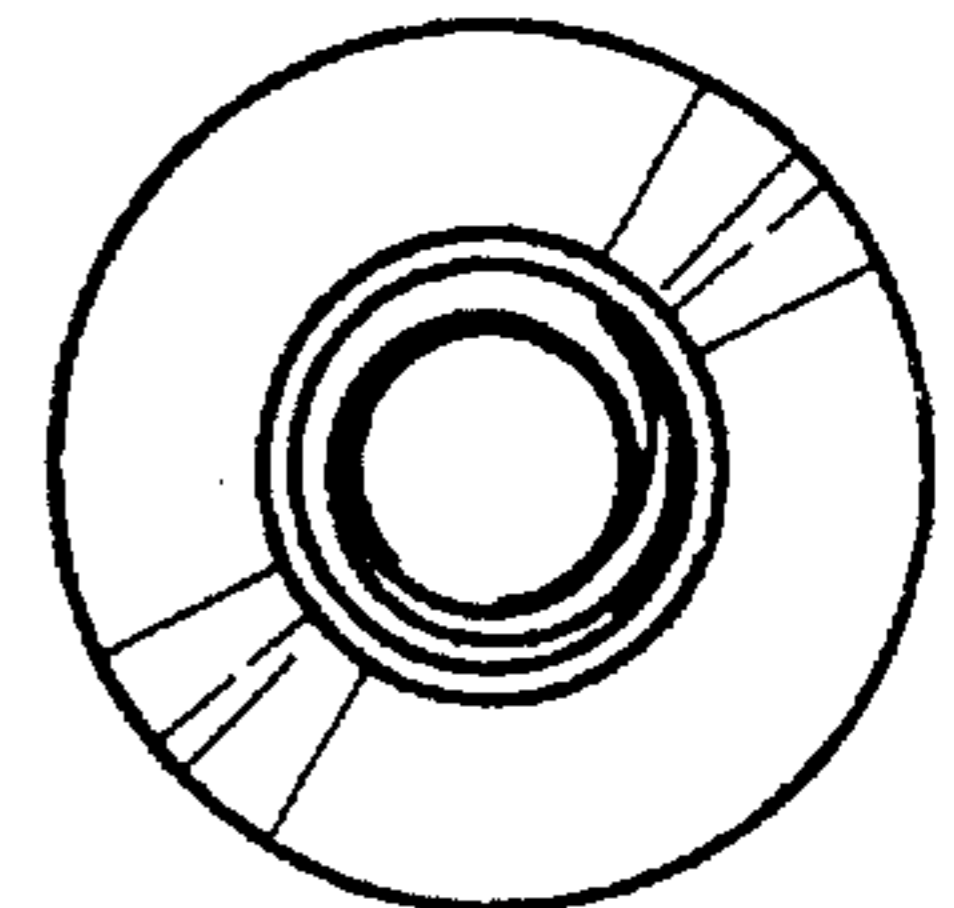

FIG. 14

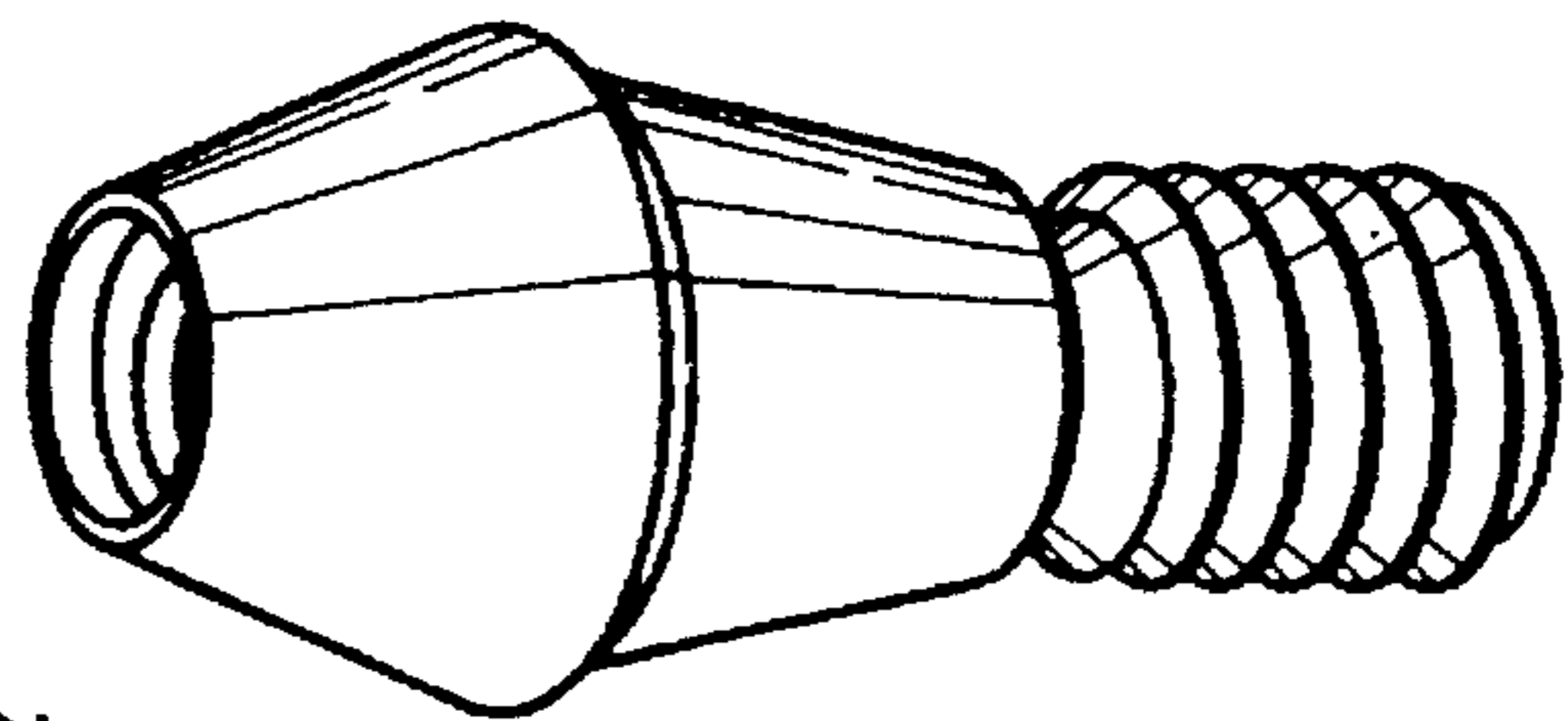

FIG. 11

Fig. 20

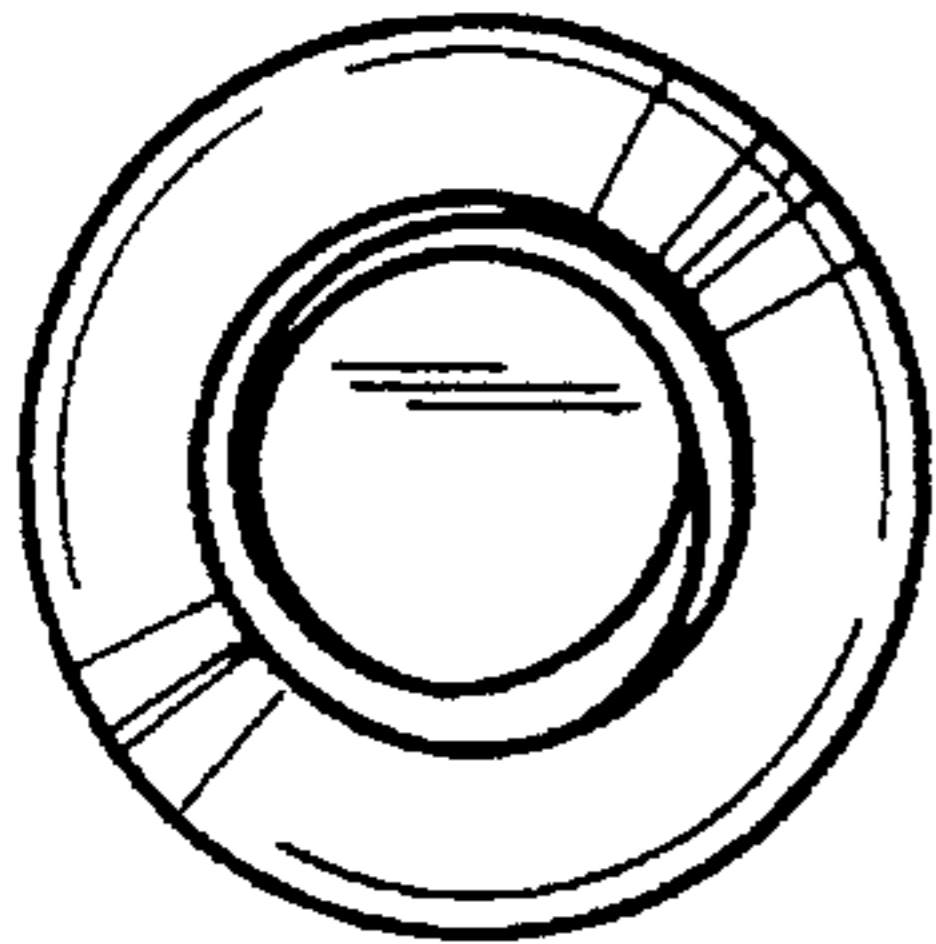
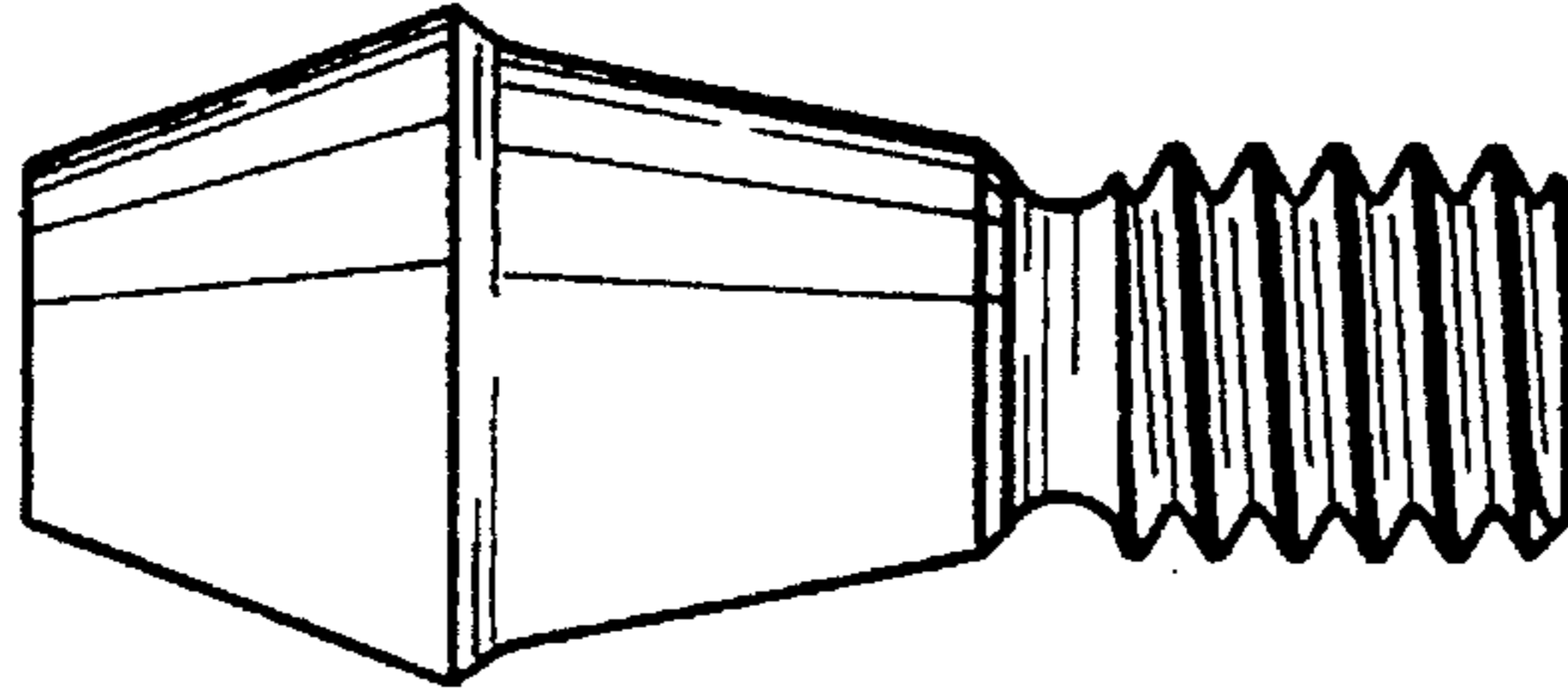

Fig. 17

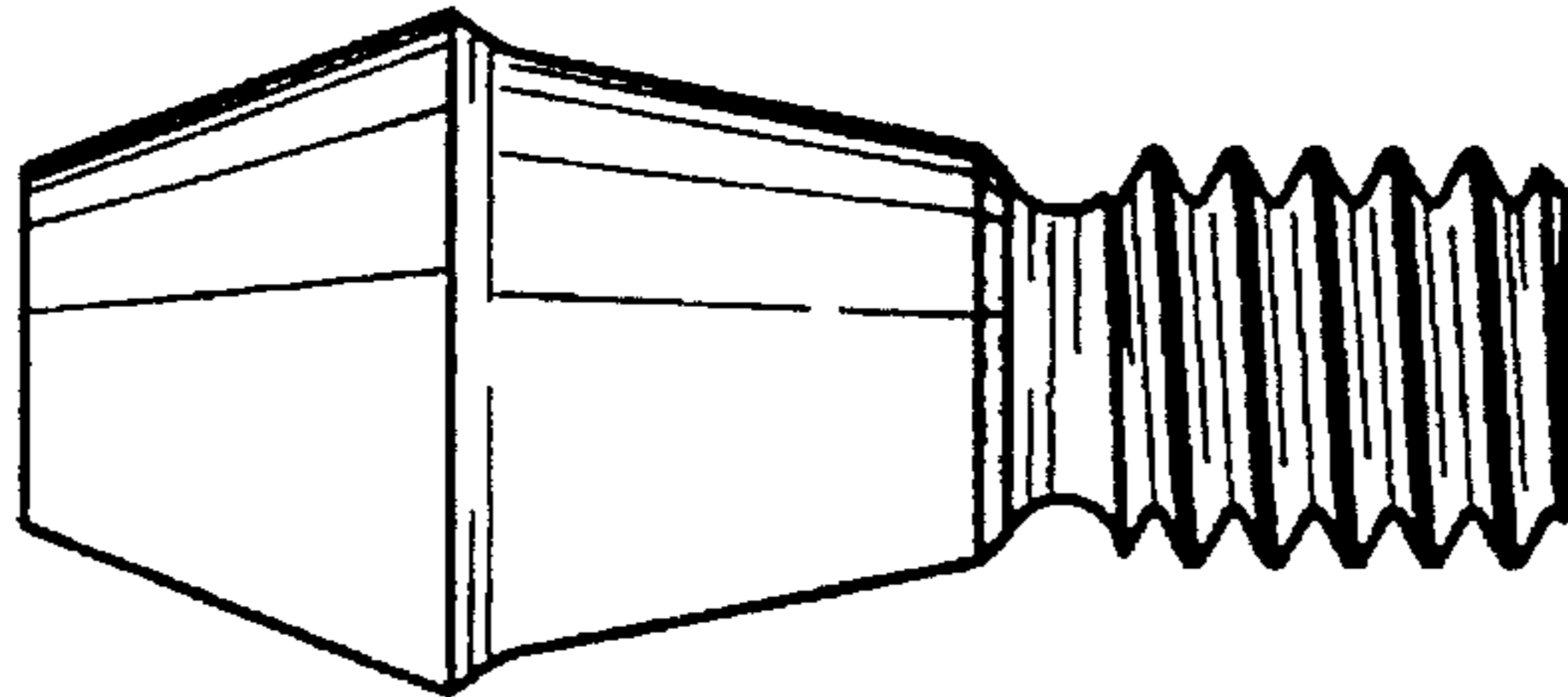

Fig. 18

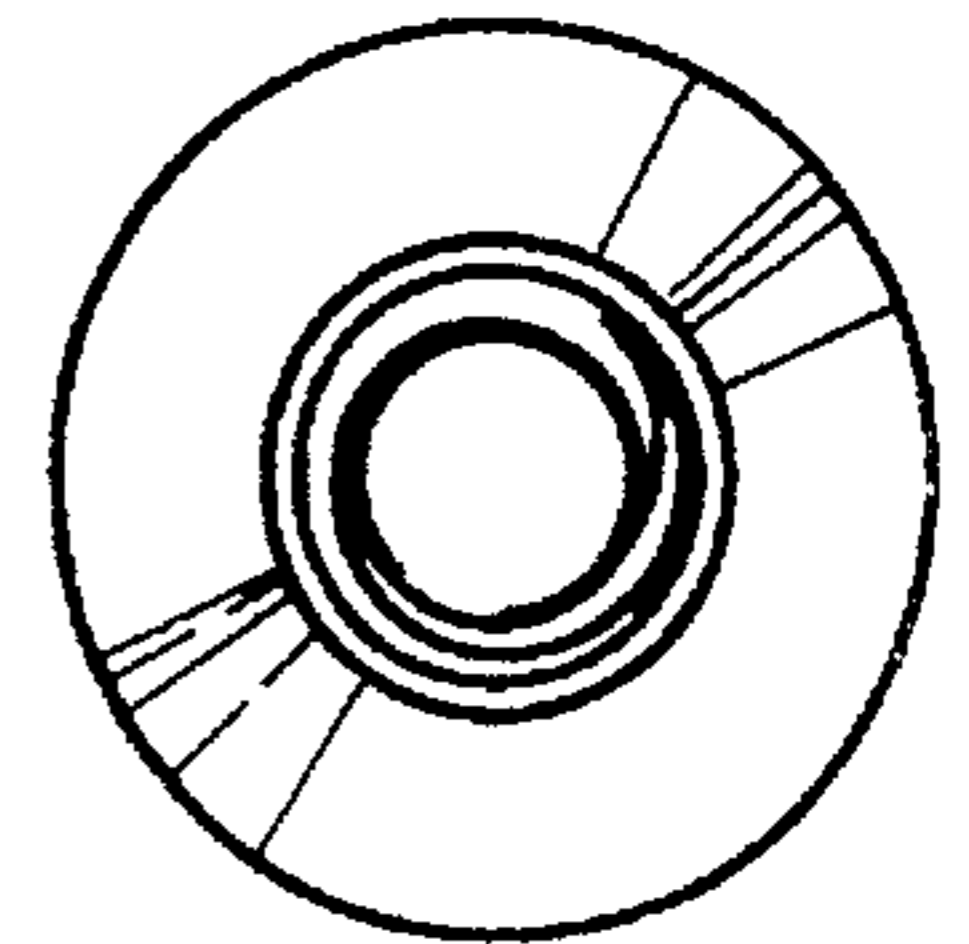

Fig. 19

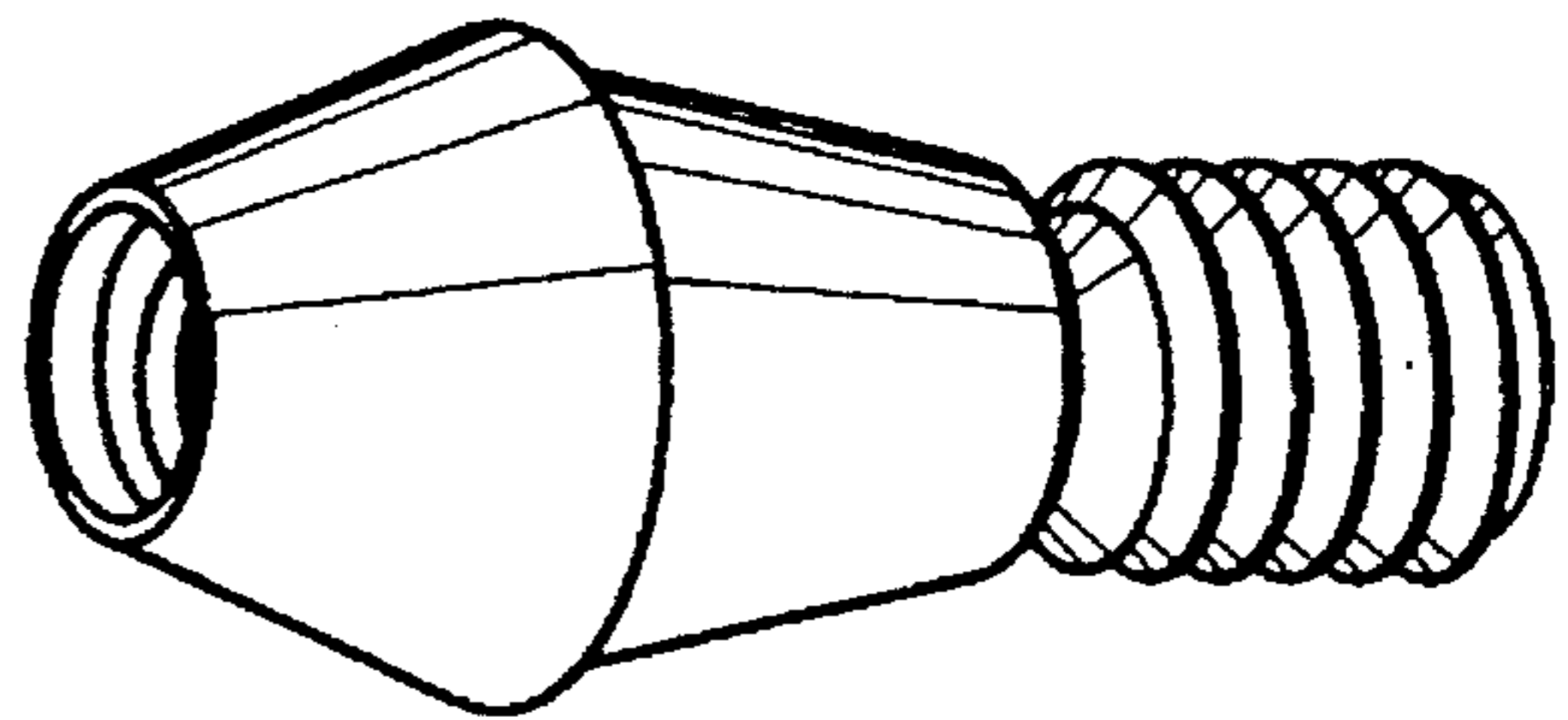

Fig. 16