



US00D373922S

United States Patent [19]

[11] Patent Number: **Des. 373,922**

Huang

[45] Date of Patent: ****Sep. 24, 1996**

[54] **VACUUM FLASK**

D. 315,472	3/1991	Balzano	D7/317
D. 347,544	6/1994	Horbochuk	D7/317 X
D. 350,255	9/1994	Daenen et al.	D7/316 X

[76] Inventor: **Frank T. S. Huang**, Suite 804, 8 Fl., No. 128, Sec. 3, Ming-Sheng E. Rd., Taipei, Taiwan

Primary Examiner—M. N. Pandozzi
Attorney, Agent, or Firm—Bacon & Thomas

[**] Term: **14 Years**

[57] **CLAIM**

[21] Appl. No.: **37,413**

The ornamental design for vacuum flask, as shown and described.

[22] Filed: **Apr. 12, 1995**

[52] U.S. Cl. **D7/319; D7/318; D7/317**

DESCRIPTION

[58] **Field of Search** D7/598, 310, 604, D7/606, 300, 302, 303, 312, 314, 316, 318, 319, 317, 320, 321, 322, 622; 222/465.1, 475.1; 99/288, 279

FIG. 1 is a perspective view of vacuum flask showing my new design thereof;
FIG. 2 is a front elevational view and the rear elevational view being a mirror image thereof;
FIG. 3 is a left side elevational view thereof;
FIG. 4 is a right side elevational view thereof;
FIG. 5 is a top plan view thereof; and,
FIG. 6 is a bottom plan view thereof.

[56] **References Cited**

U.S. PATENT DOCUMENTS

D. 195,598	7/1963	Bernadotte et al.	D7/317
D. 232,897	9/1974	Kemnitzer	D7/317
D. 300,708	4/1989	Minuti	D7/317
D. 306,547	3/1990	Wolfenden	D7/319 X

1 Claim, 5 Drawing Sheets

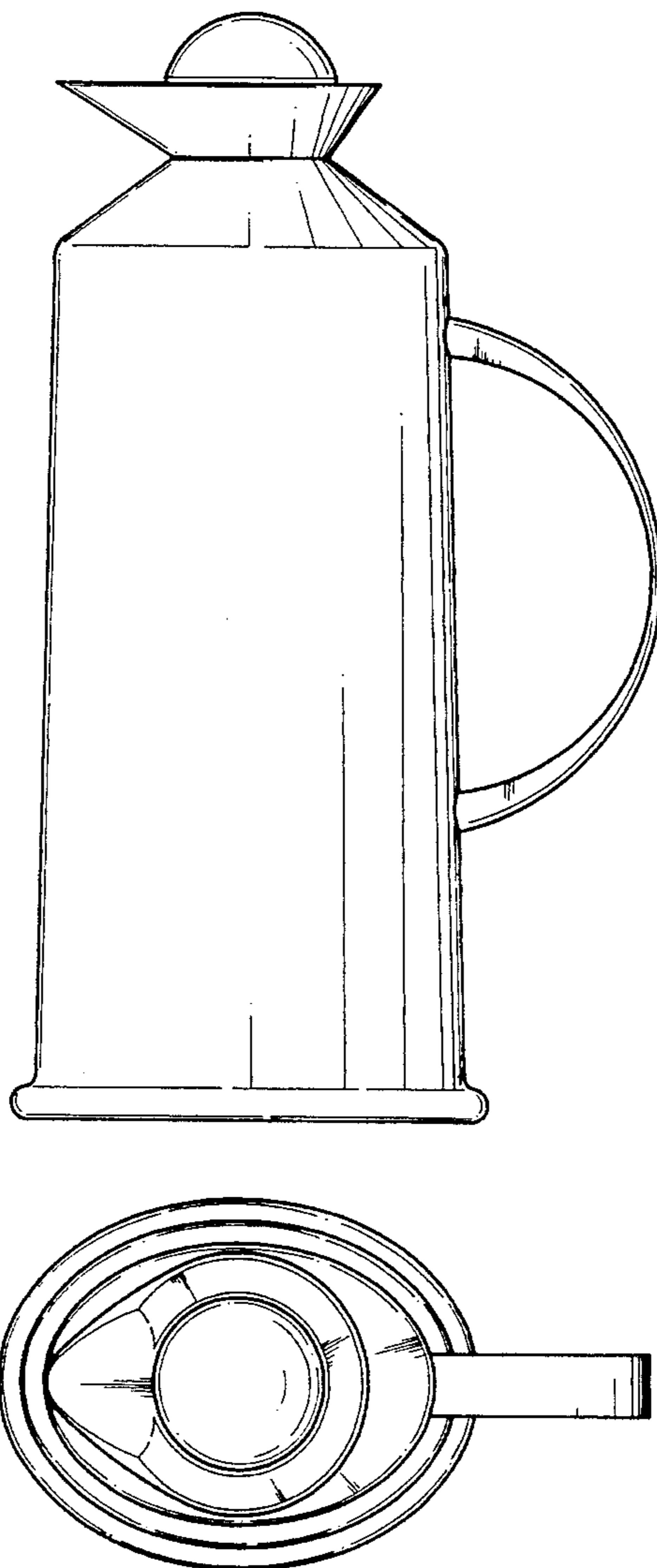

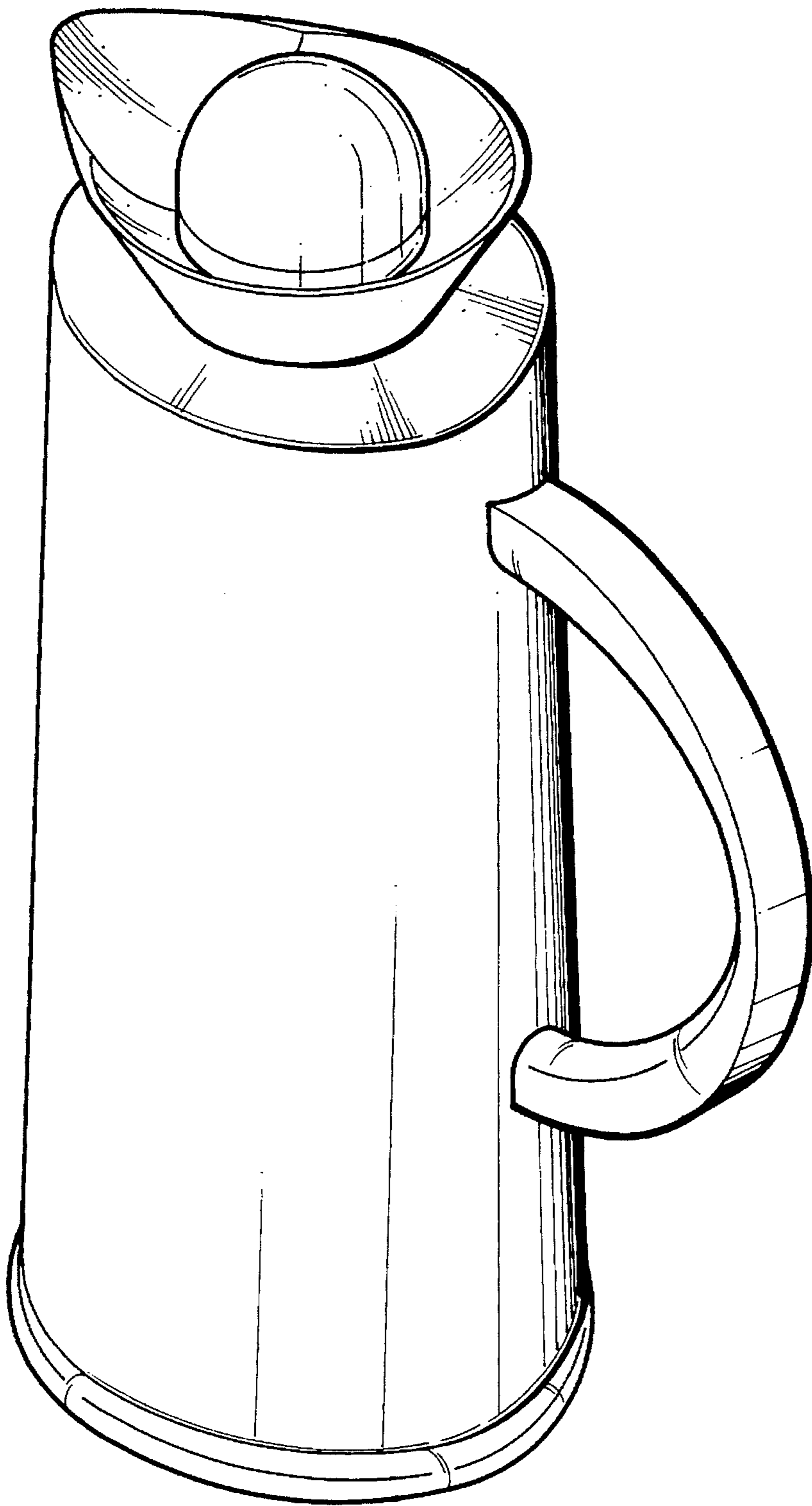

Fig. 1

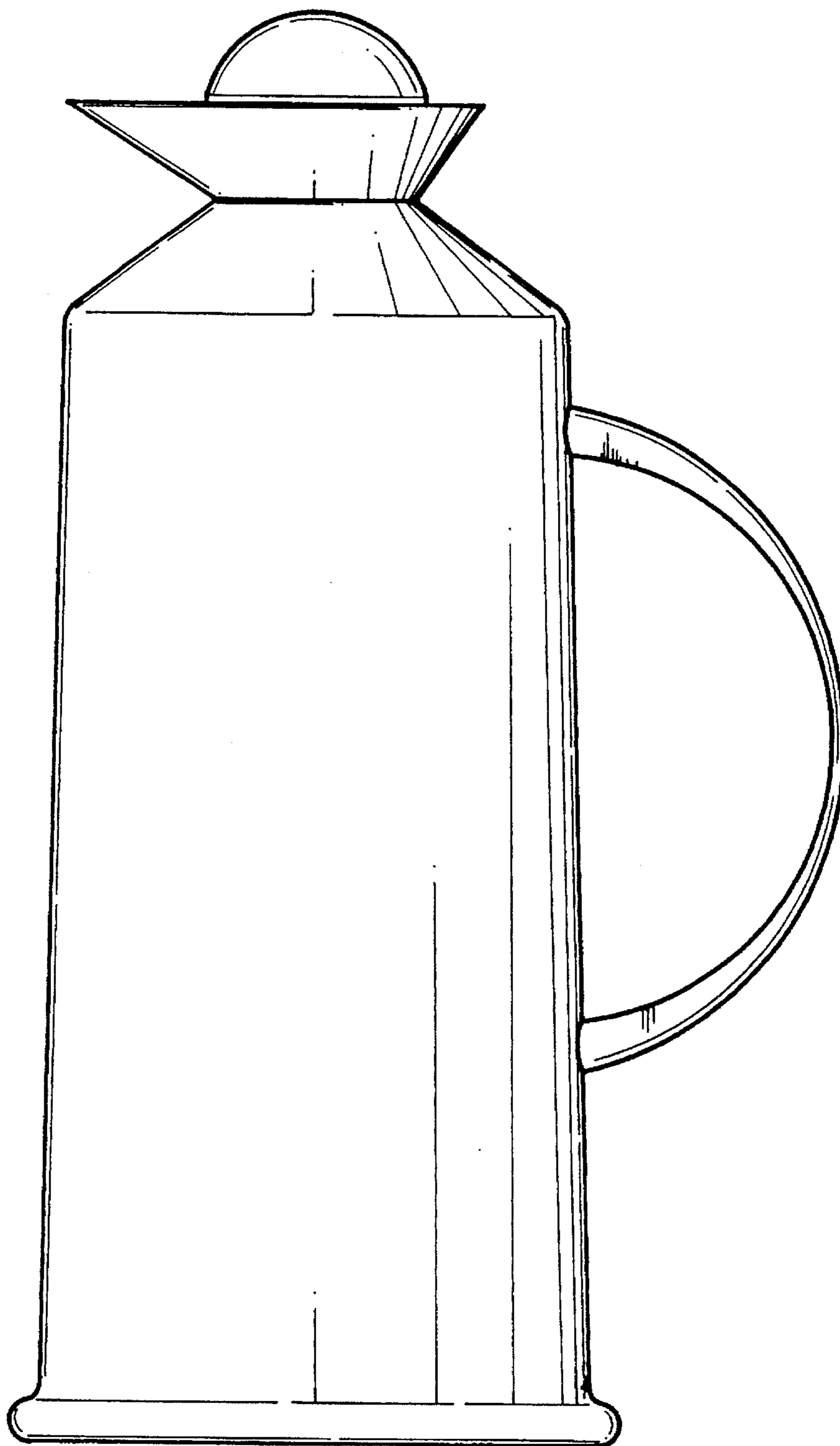

Fig. 2

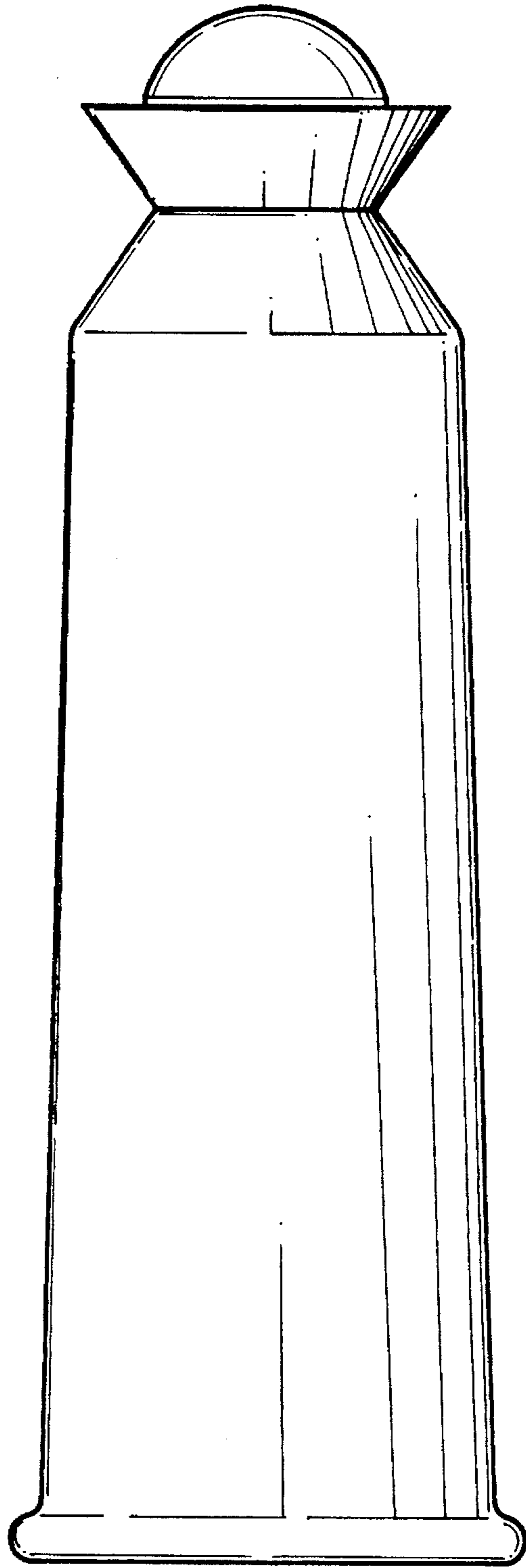

Fig. 3

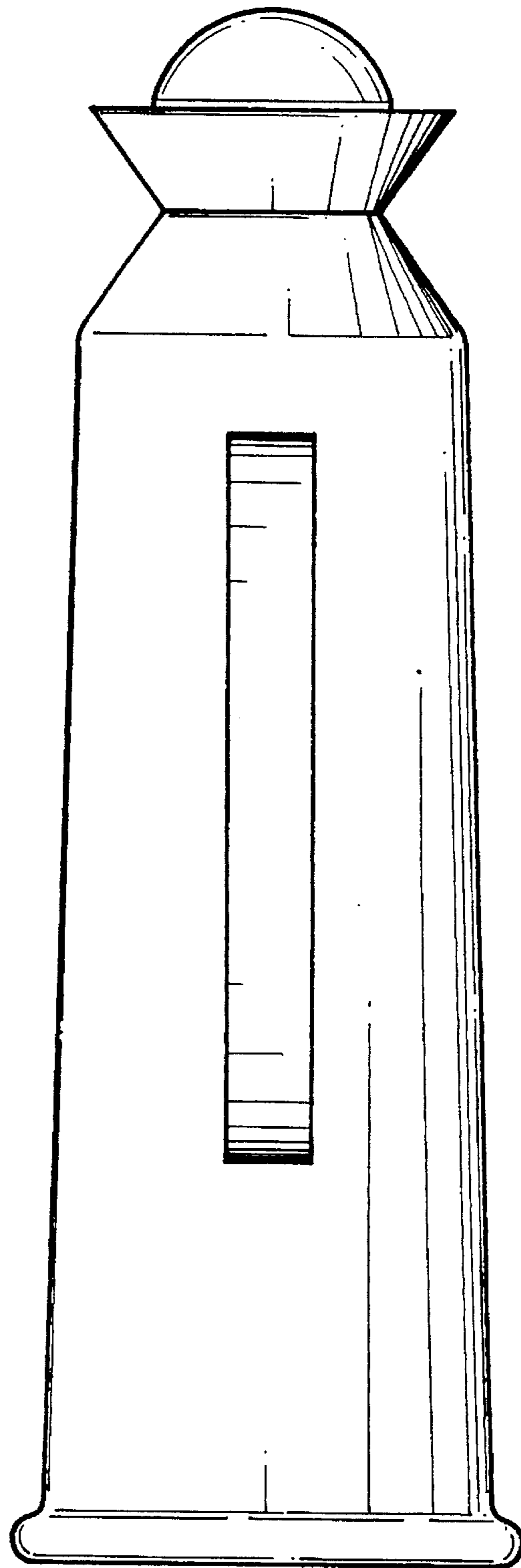

Fig. 4

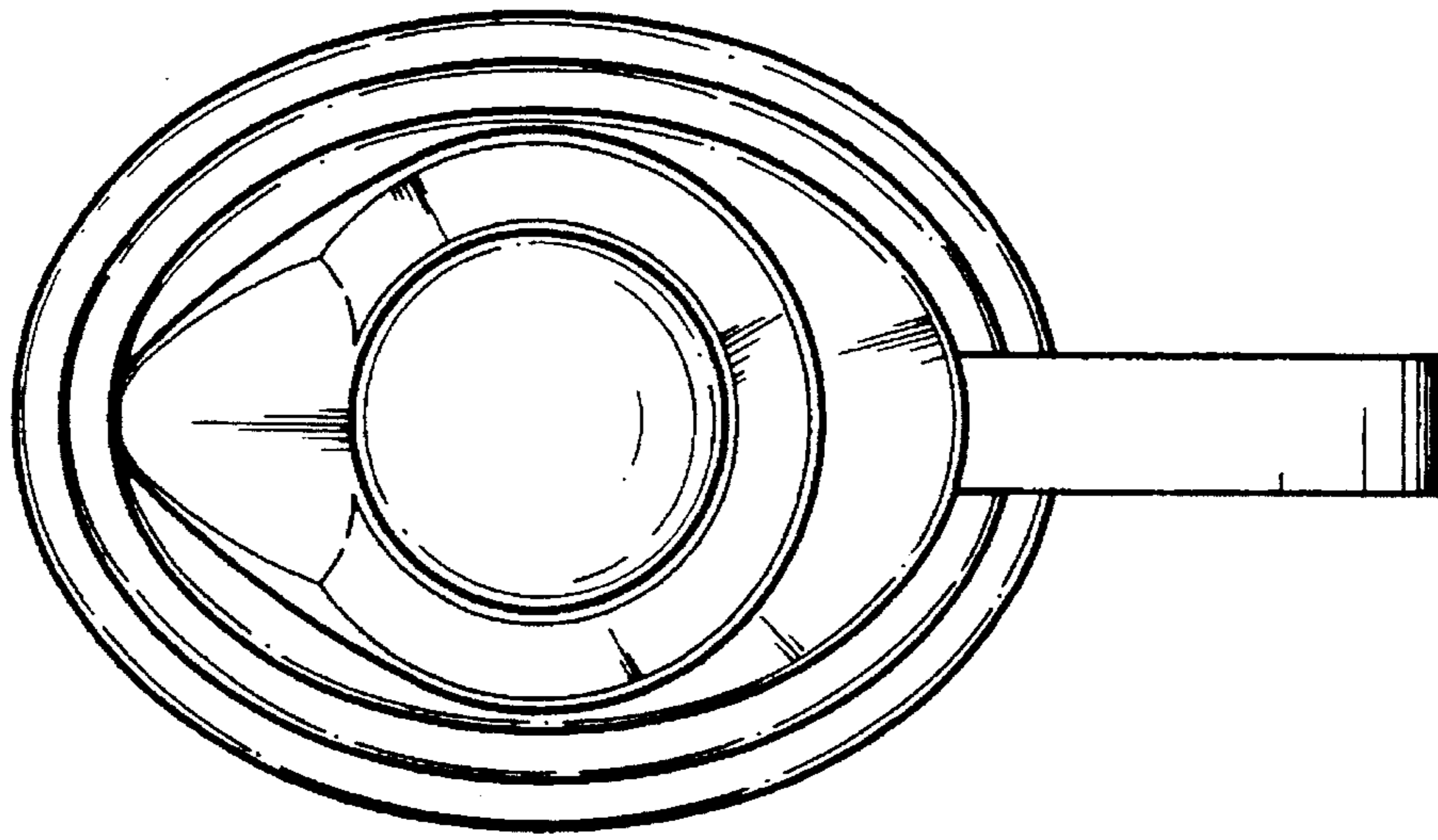

Fig. 5

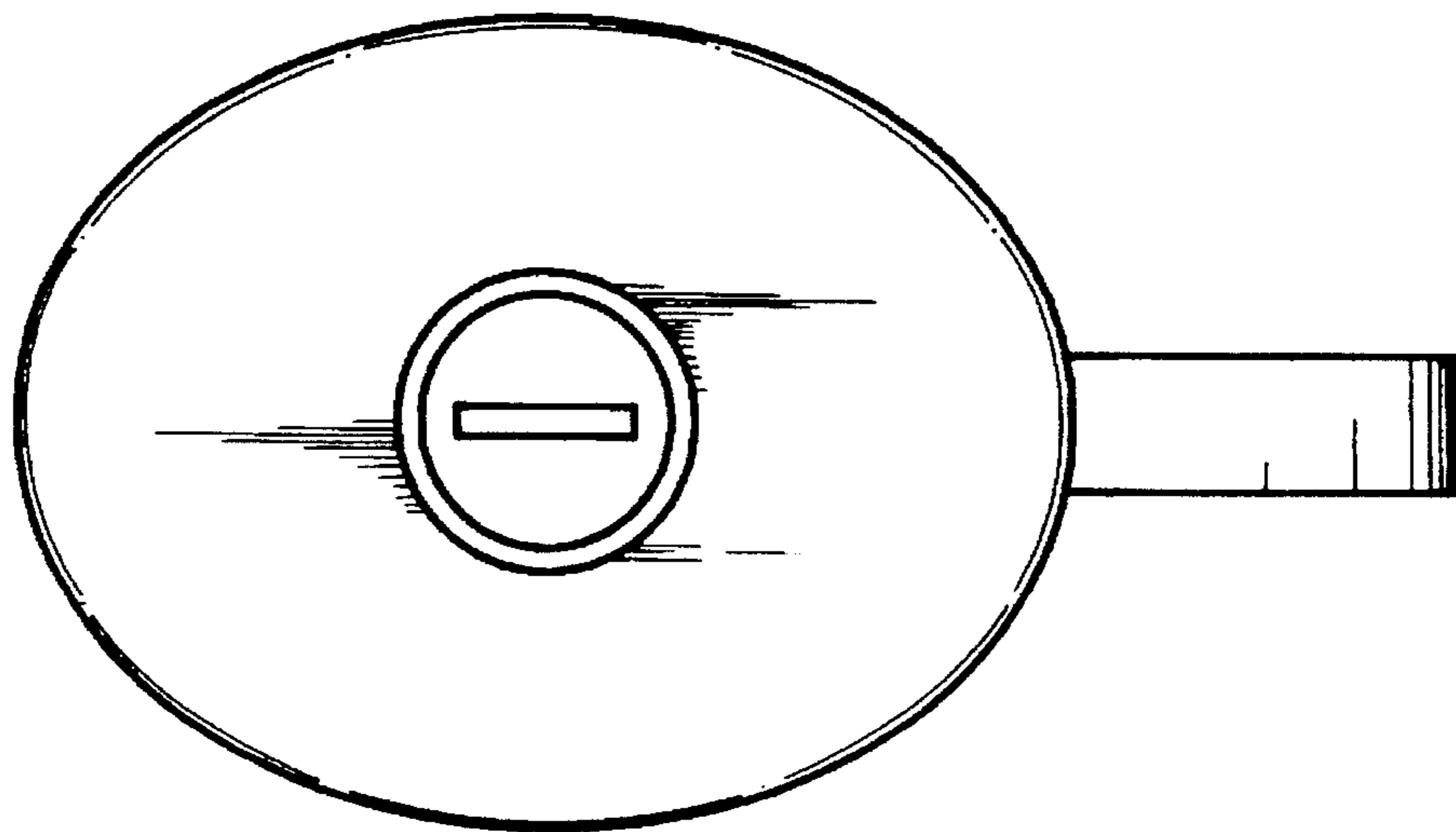

Fig. 6