



US00D373789S

United States Patent [19]

Narushima

[11] Patent Number: **Des. 373,789**

[45] Date of Patent: ****Sep. 17, 1996**

[54] **OUTPUT PAPER DISTRIBUTOR**

[75] Inventor: **Hideki Narushima**, Yokohama, Japan

[73] Assignee: **Canon Kabushiki Kaisha**, Tokyo, Japan

[**] Term: **14 Years**

[21] Appl. No.: **38,727**

[22] Filed: **May 12, 1995**

[30] **Foreign Application Priority Data**

Nov. 14, 1994 [JP] Japan 6-34662

[52] U.S. Cl. **D18/48**

[58] Field of Search D18/36-39, 46-49;
271/278, 287, 293; 365/322, 323

[56] **References Cited**

U.S. PATENT DOCUMENTS

D. 295,184	4/1988	Aoyama	D16/32
D. 309,632	7/1990	Komada et al.	D18/42
D. 309,912	8/1990	Hirata	D18/42
D. 320,809	10/1991	Hiroki	D18/48
D. 333,834	3/1993	Isomoto et al.	D18/48

D. 338,228	8/1993	Suzuki et al.	D18/48
D. 354,306	1/1995	Shimizu	D18/48

OTHER PUBLICATIONS

Harris/3M Brochure, Dec. 1988; 6242 Copier; 20 Bin Sorter.

Primary Examiner—Nelson C. Holtje
Assistant Examiner—Caron D. Venyar
Attorney, Agent, or Firm—Fitzpatrick, Cella, Harper & Scinto

[57] **CLAIM**

The ornamental design for an output paper distributor, as shown and described.

DESCRIPTION

FIG. 1 is a front elevational view of an output paper distributor showing my new design; FIG. 2 is a rear elevational view thereof; FIG. 3 is a top plan view thereof; FIG. 4 is a bottom plan view thereof; FIG. 5 is a left side elevational view thereof; FIG. 6 is a right side elevational view thereof; and, FIG. 7 is a perspective view thereof.

1 Claim, 4 Drawing Sheets

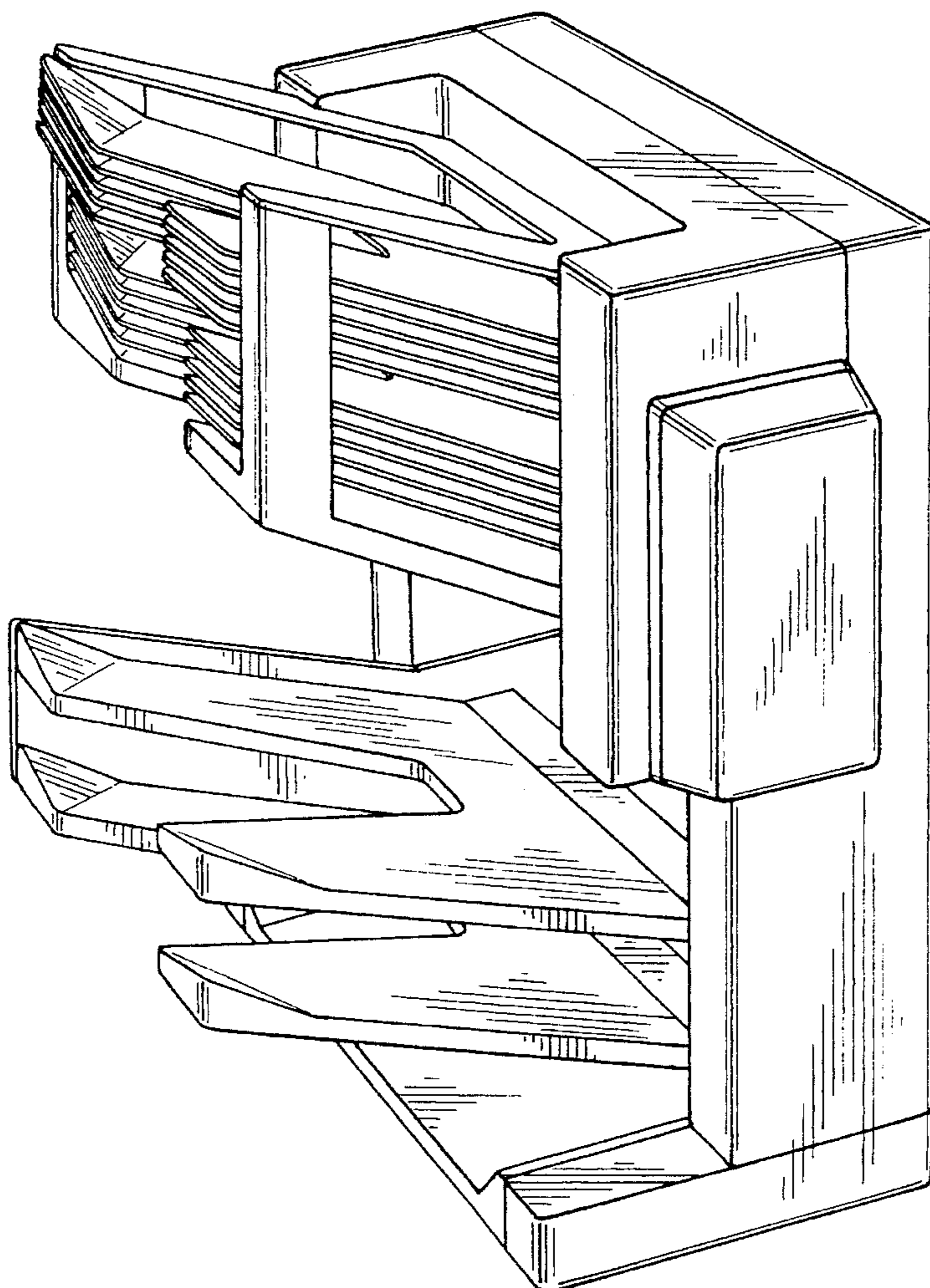

FIG. 2

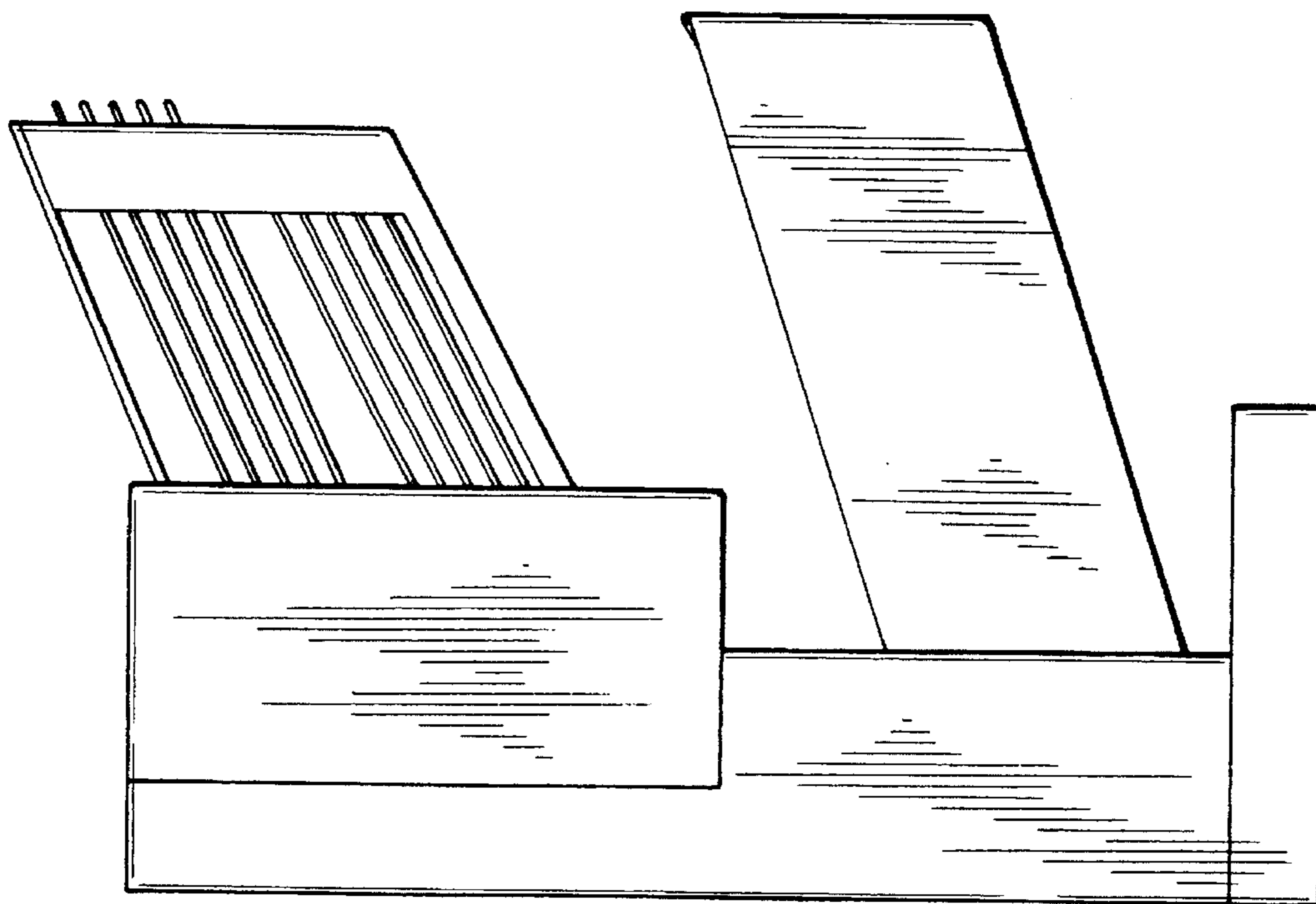

FIG. 1

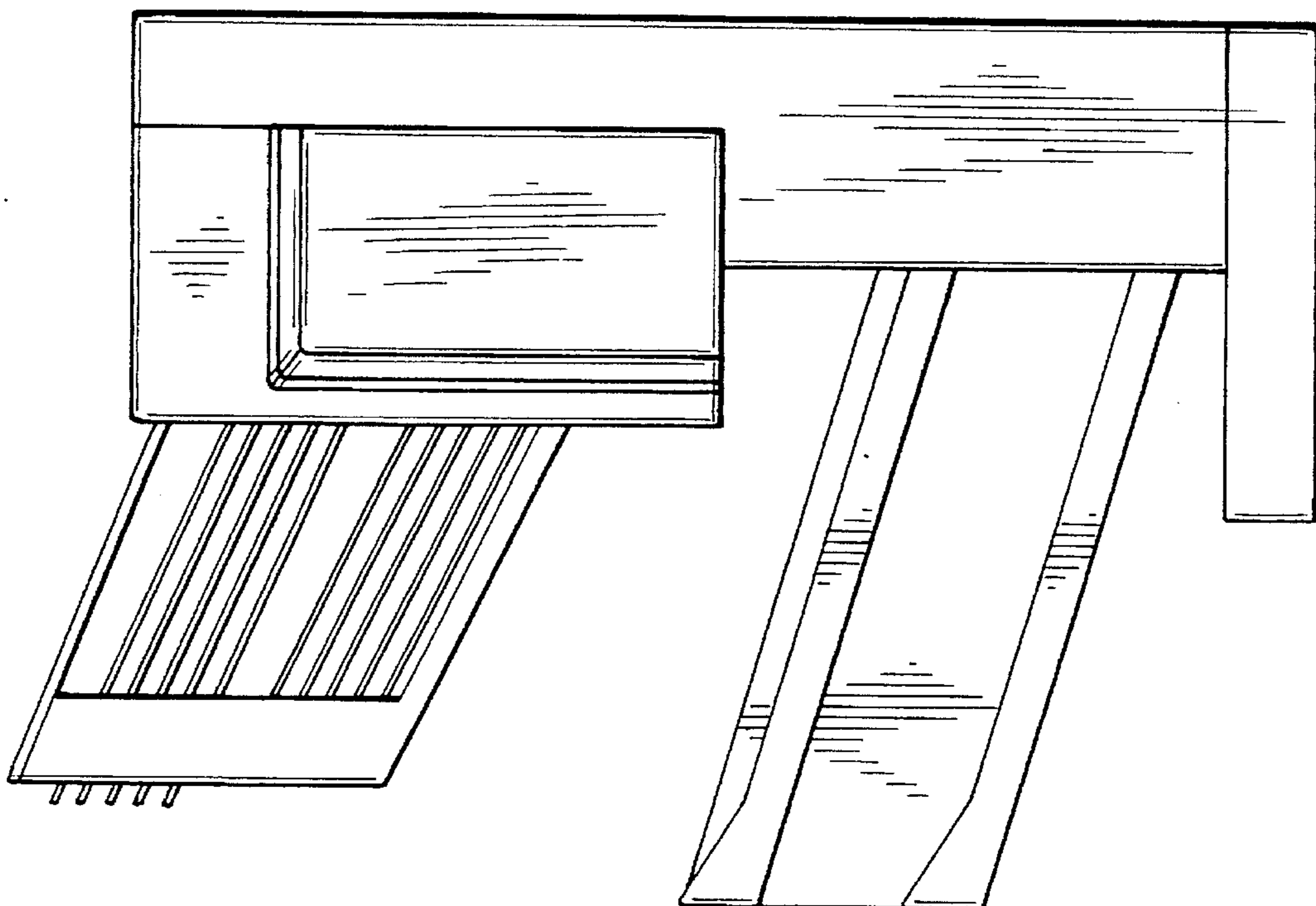

FIG. 3

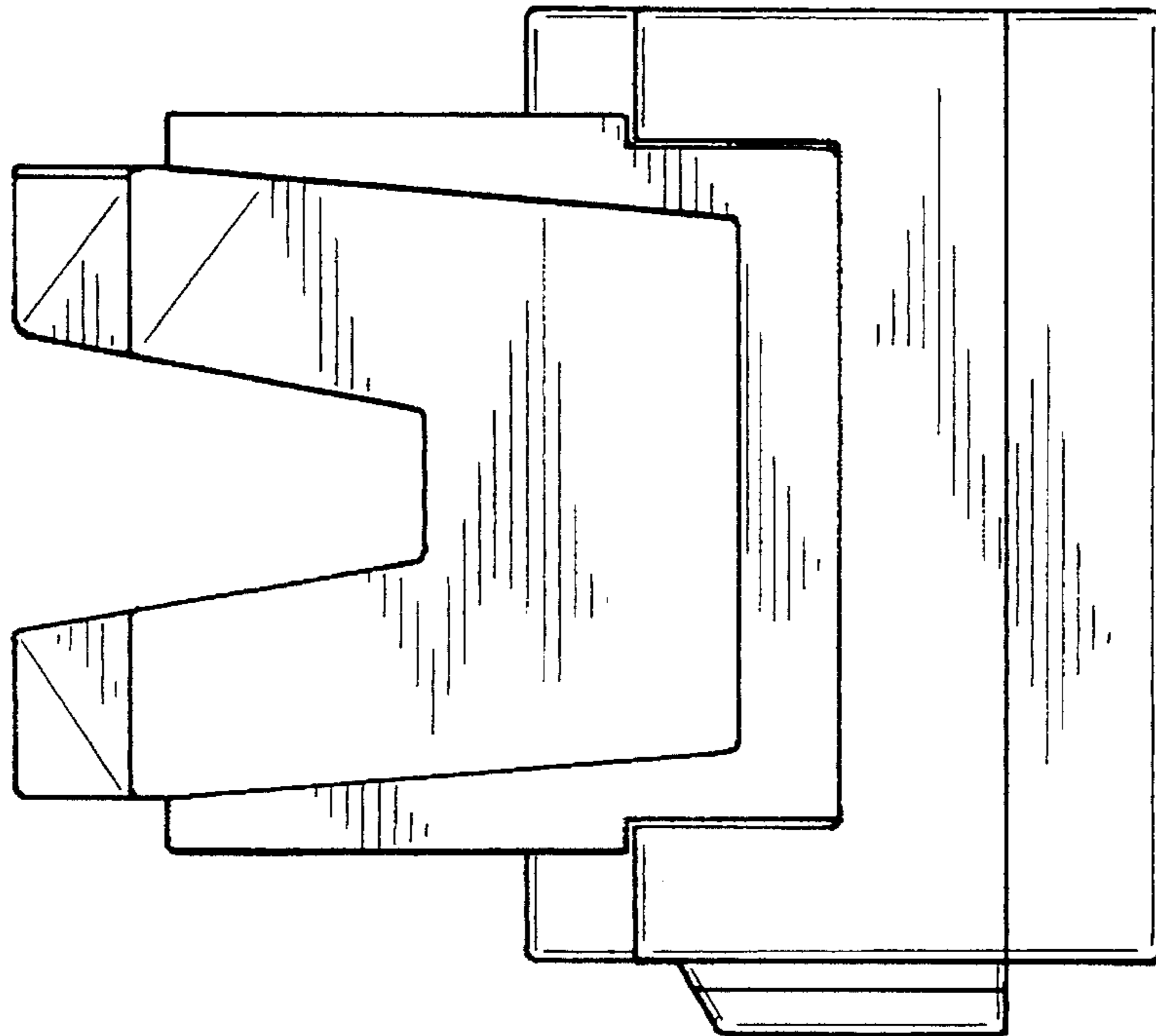

FIG. 4

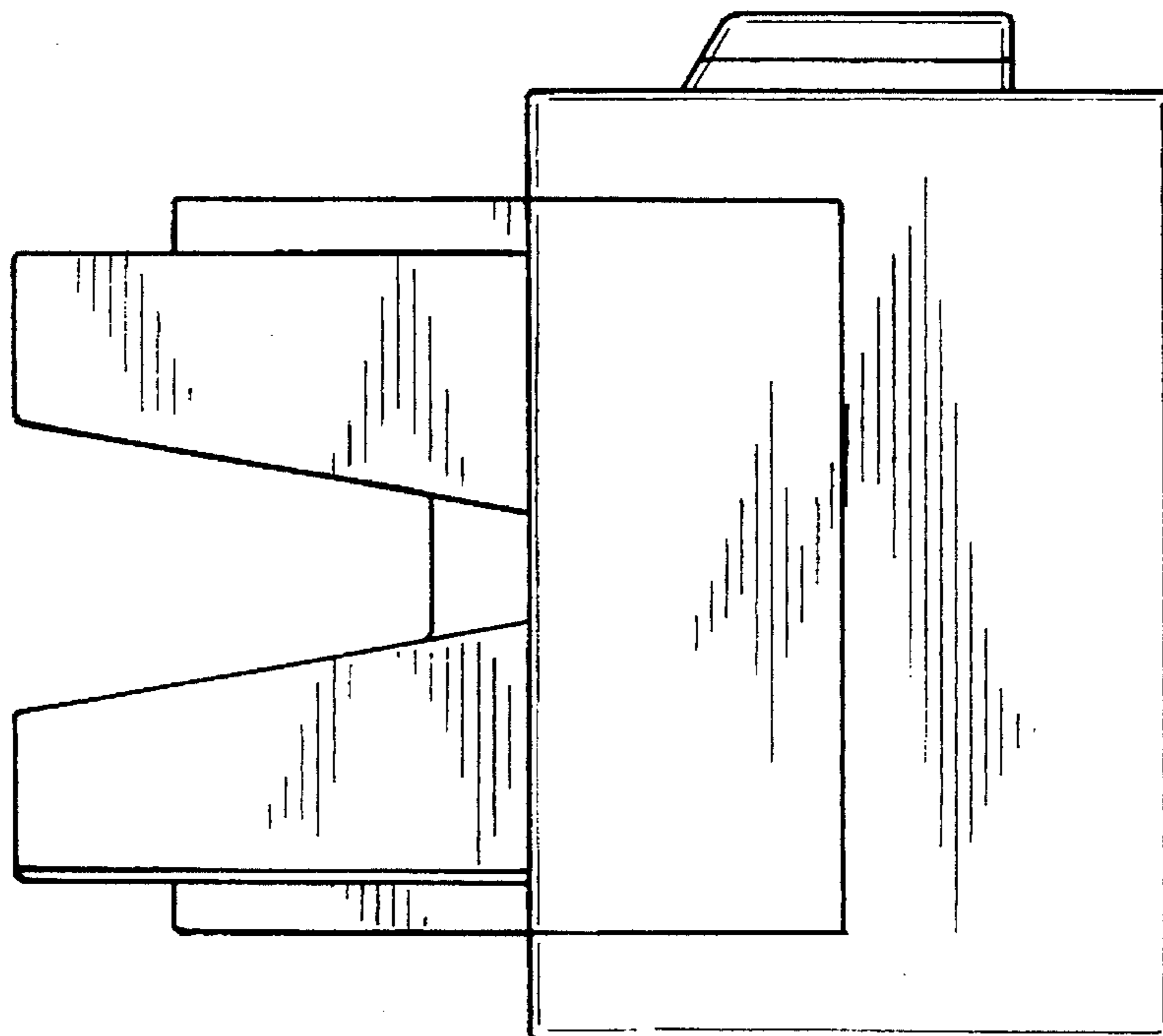

FIG. 6

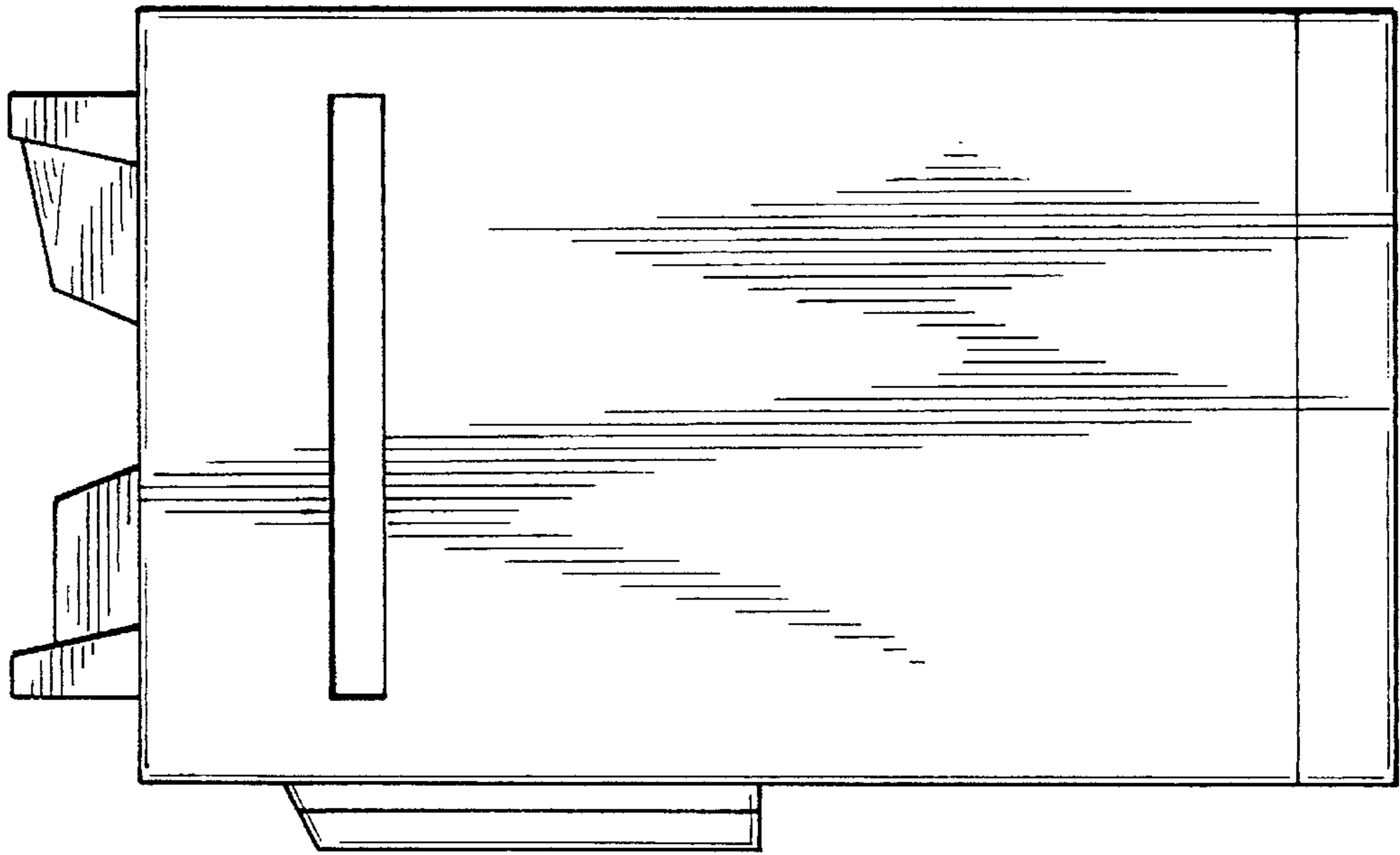

FIG. 5

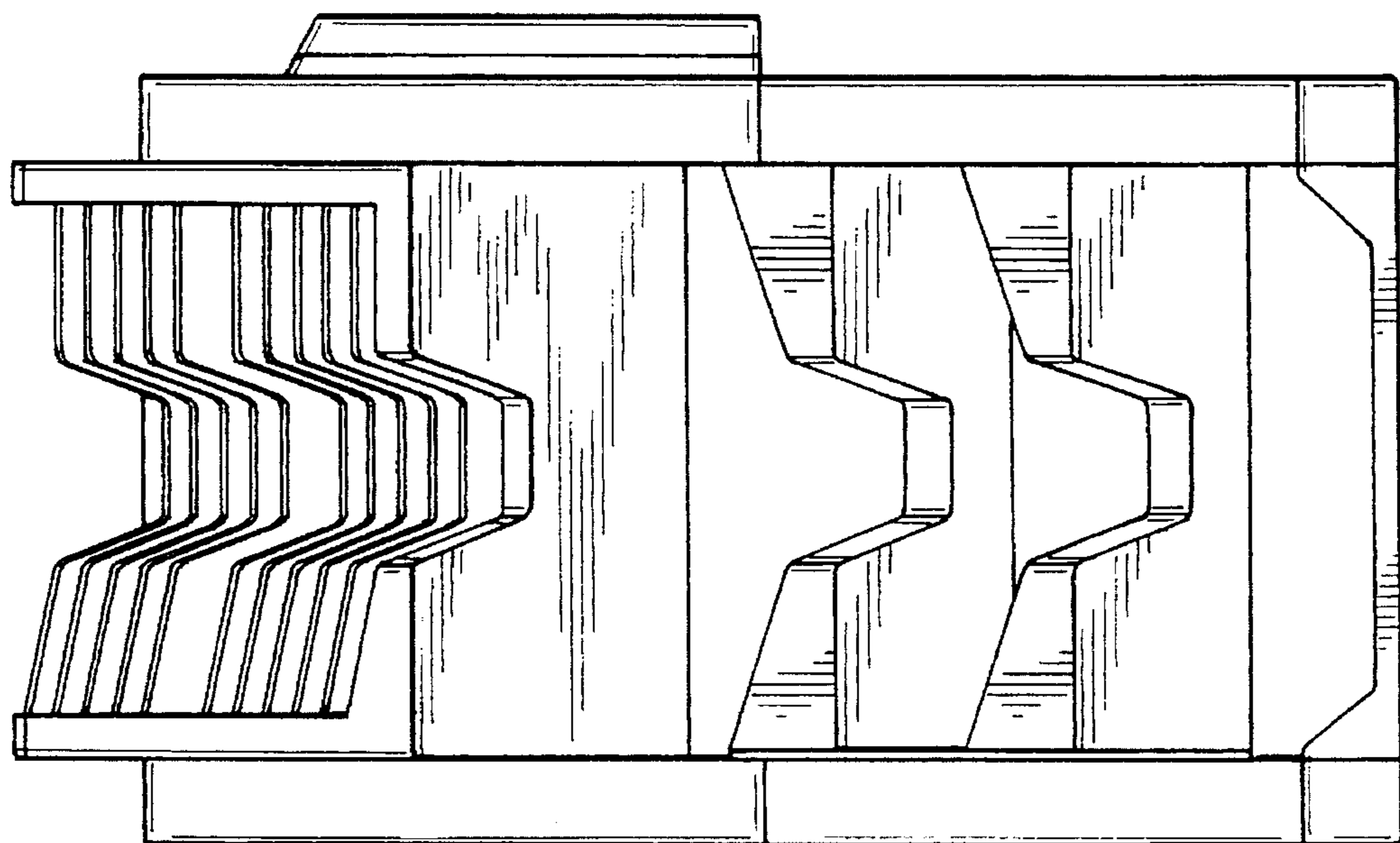

FIG. 7

