



US00D373761S

United States Patent [19]

Yu

[11] Patent Number: **Des. 373,761**

[45] Date of Patent: ****Sep. 17, 1996**

[54] **SUPPORT STAND FOR COMPUTER MONITOR AND SPEAKERS**

[76] Inventor: **Chung C. Yu**, 87 Townsend St.,
Walton, N.Y. 13856

[**] Term: **14 Years**

[21] Appl. No.: **35,260**

[22] Filed: **Feb. 23, 1995**

[52] U.S. Cl. **D14/114; D14/224**

[58] Field of Search D14/114, 211,
D14/224; D6/510; 248/917-924, 176.1-176.3,
419, 422, 396, 279.1, 163.1, 678, 407,
448, 639; 211/70.1, 135; 108/96, 42, 137,
139, 26

[56] **References Cited**

U.S. PATENT DOCUMENTS

D. 361,447 8/1995 Moore D14/114 X
4,560,132 12/1985 Wilder D14/114 X

4,765,580 8/1988 Wright 248/176.1 X
4,863,124 9/1989 Ball et al. 108/42 X
5,190,258 3/1993 Yu 248/918 X
5,377,598 1/1995 Kirchner et al. 248/918 X

Primary Examiner—Freda Nunn
Attorney, Agent, or Firm—Charles J. Brown

[57] **CLAIM**

The ornamental design for support stand for computer monitor and speakers, as shown and described.

DESCRIPTION

FIG. 1 is a perspective view of a support stand for computer monitor and speaker showing my new design;
FIG. 2 is a top plan view of the support stand of FIG. 1;
FIG. 3 is a front elevation of the support stand of FIG. 1;
FIG. 4 is a rear elevation of the support stand of FIG. 1;
FIG. 5 is a left side elevation of the support stand of FIG. 1;
and,
FIG. 6 is a bottom plan view of the support stand of FIG. 1.

1 Claim, 4 Drawing Sheets

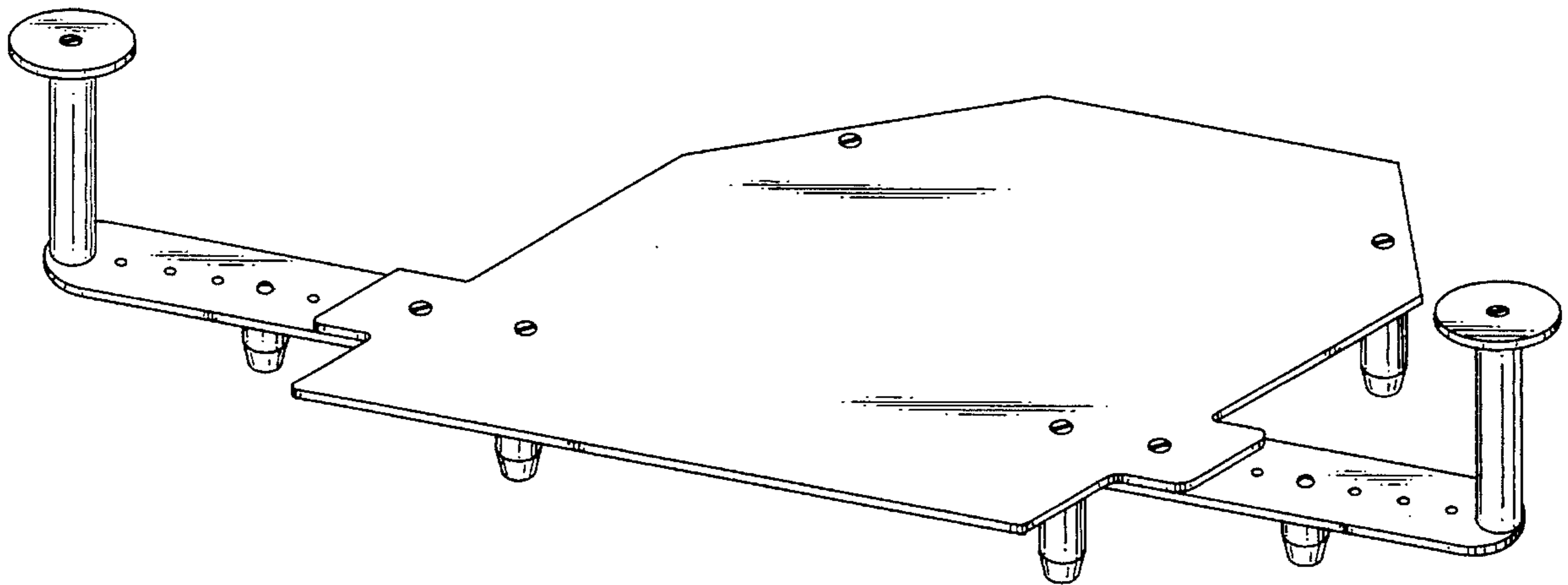

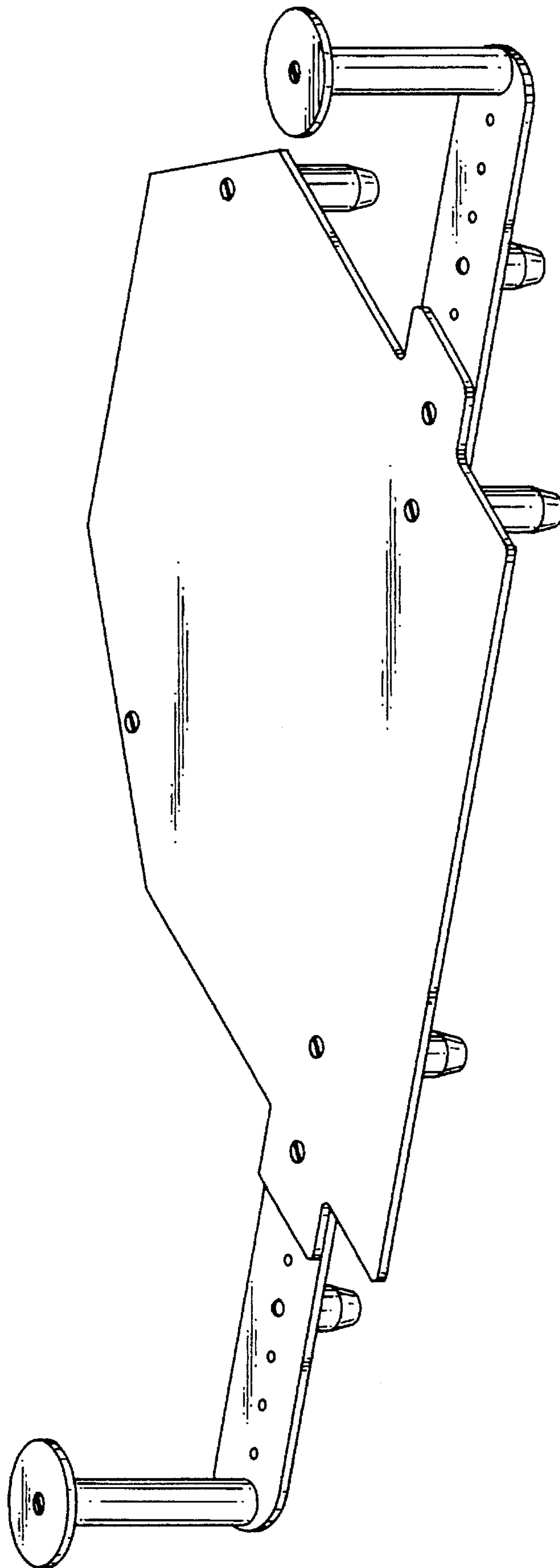
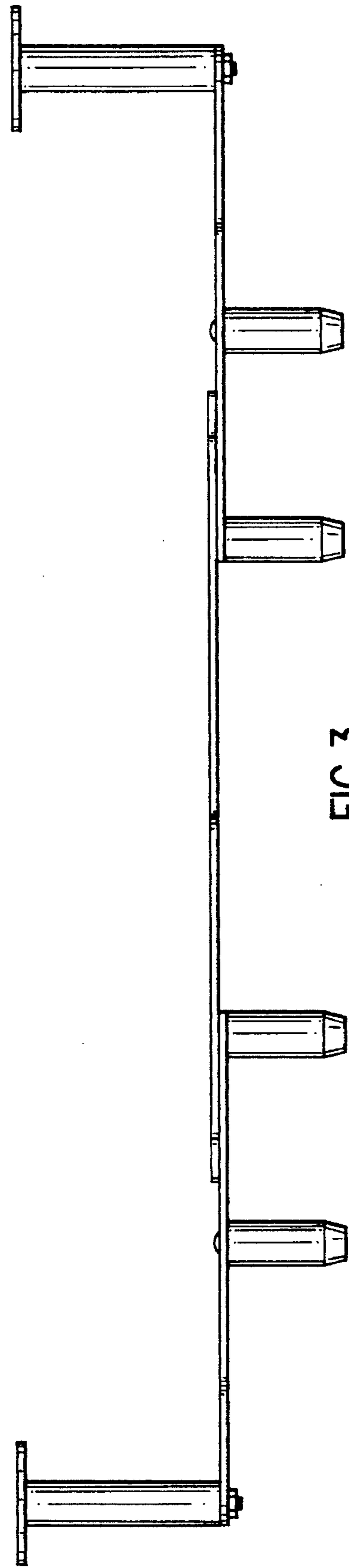
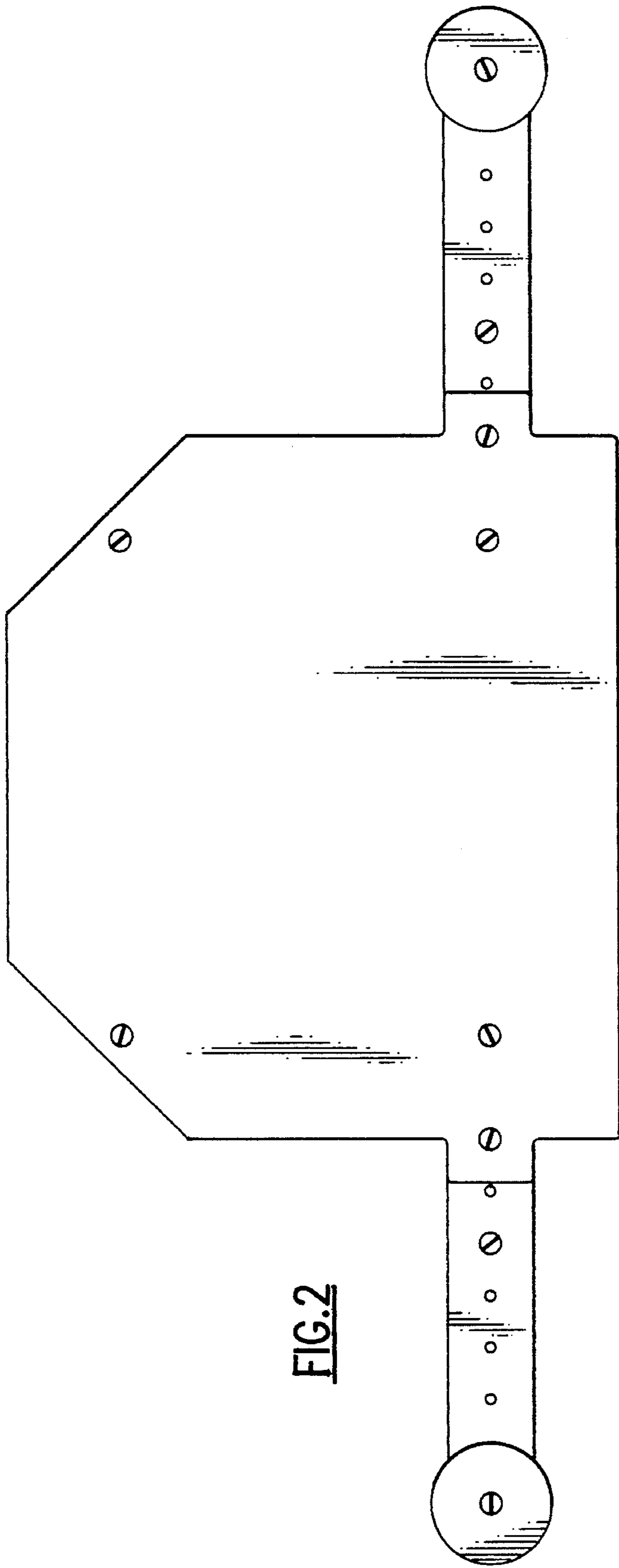

FIG.1



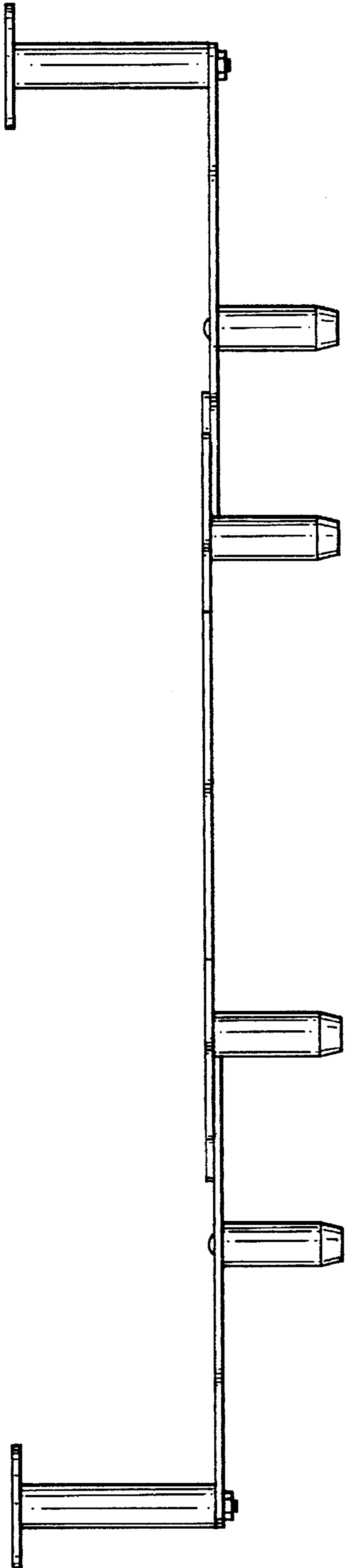

FIG. 4

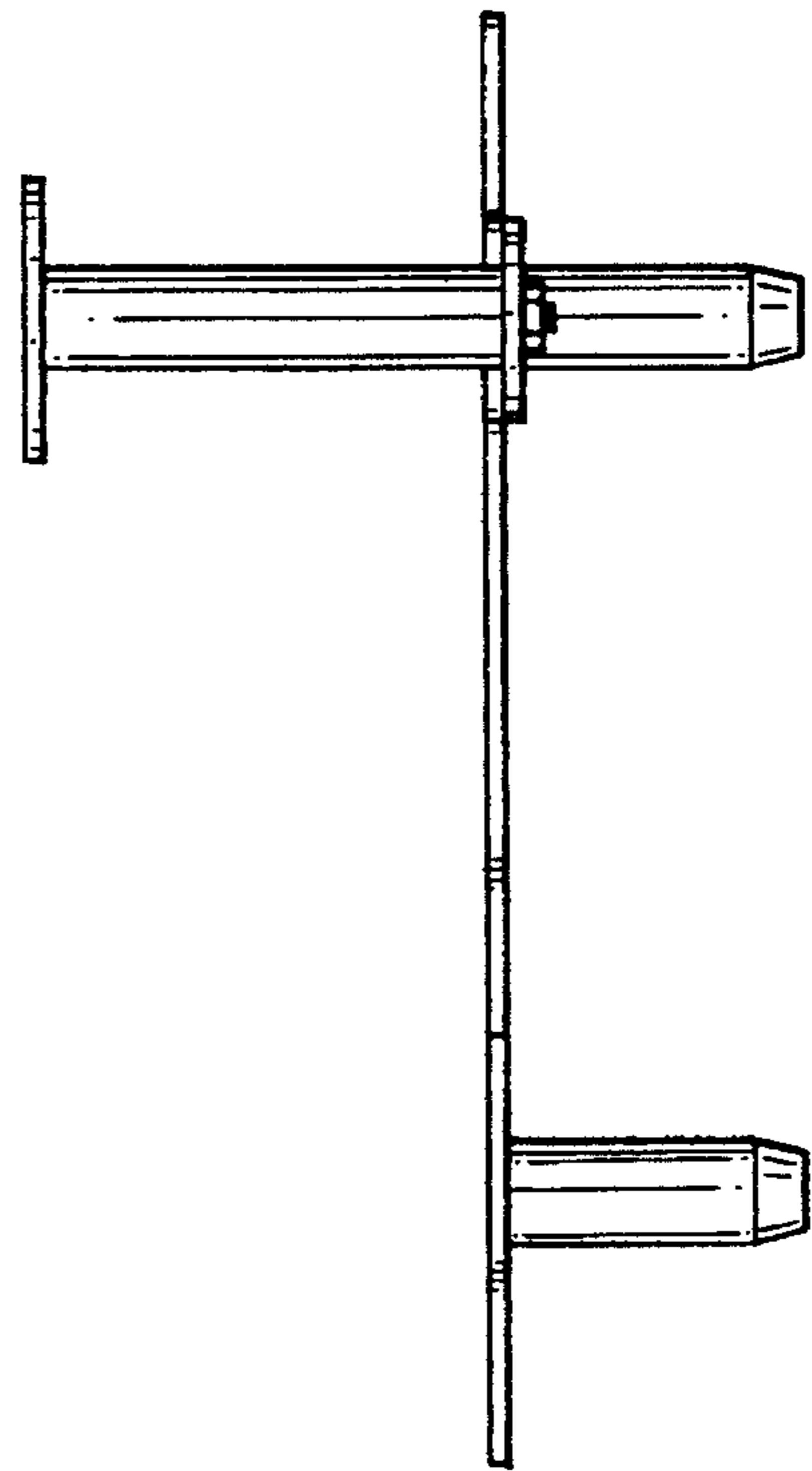

FIG. 5

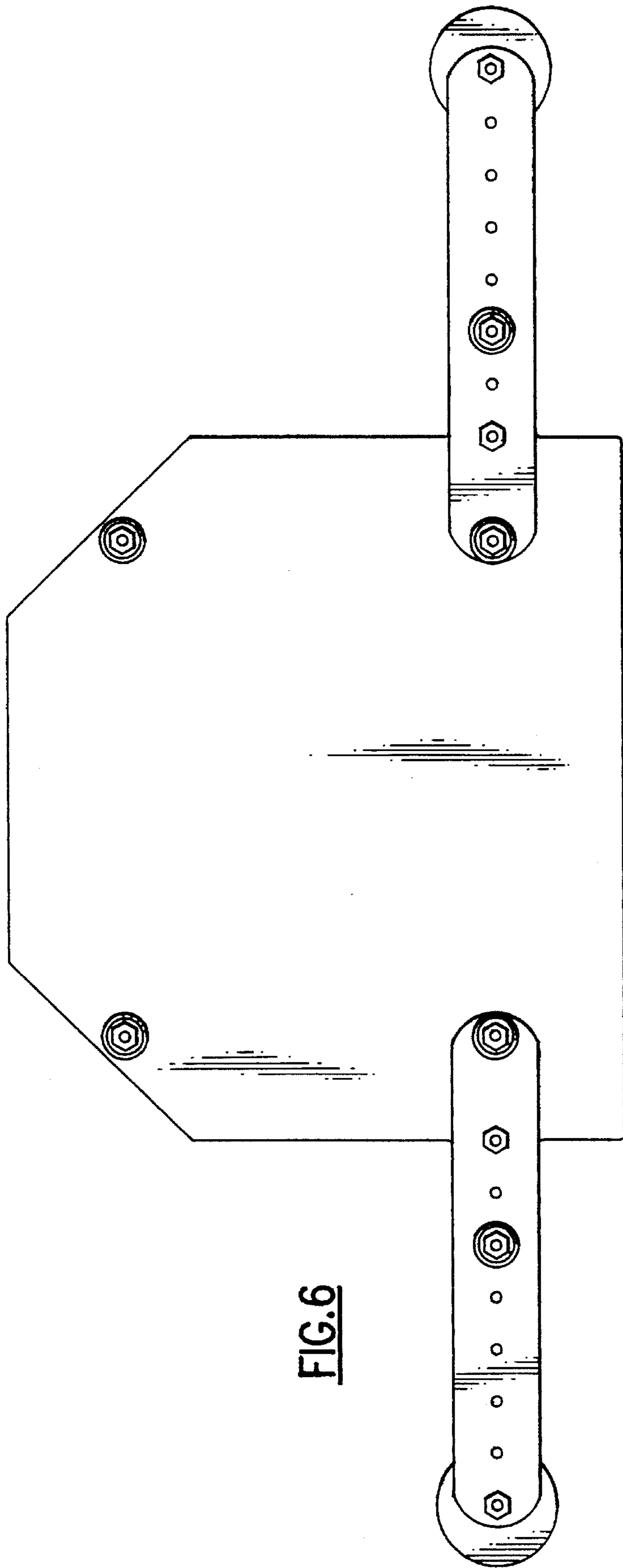

FIG. 6