



US00D373737S

United States Patent [19]

Kurisaki et al.

[11] Patent Number: **Des. 373,737**

[45] Date of Patent: ****Sep. 17, 1996**

[54] **SOLID STATE PRESSURE DETECTOR**

[75] Inventors: **Shogo Kurisaki; Masao Kataoka; Kuniko Suzuki**, all of Ibaraki, Japan

[73] Assignee: **SMC Kabushiki Kaisha**, Tokyo, Japan

[**] Term: **14 Years**

[21] Appl. No.: **35,986**

[22] Filed: **Mar. 10, 1995**

[30] **Foreign Application Priority Data**

Sep. 13, 1994 [JP] Japan 6-27788

[52] **U.S. Cl.** **D10/83; D10/85; D10/96**

[58] **Field of Search** **D10/83, 85, 96; 73/431, 728, 861.74; 200/83 B, 83 N**

[56] **References Cited**

U.S. PATENT DOCUMENTS

D. 251,371	3/1979	Schwartz	D10/85
D. 254,781	4/1980	Holm	D10/85
D. 263,125	2/1982	Taylor	D10/85
4,977,413	12/1990	Yamanaka et al.	200/83 N
5,315,878	5/1994	Birenheide	200/83 N

OTHER PUBLICATIONS

Ser. No. 29/035,986, filing date Mar. 10, 1995, status pending.

Ser. No. 08/443,375, filing date May 17, 1995, status pending.

Ser. No. 29/035,985, filing date Mar. 10, 1995, status pending.

Ser. No. 29/035,982, filing date Mar. 10, 1995, status pending.

Ser. No. 29/035,984, filing date Mar. 10, 1995, status pending.

Primary Examiner—Antoine Duval Davis
Attorney, Agent, or Firm—Oblon, Spivak, McClelland, Maier, & Neustadt, P.C.

[57] **CLAIM**

The ornamental design for a solid state pressure detector, as shown and described.

DESCRIPTION

FIG. 1 is a top plan view of a solid state pressure detector, showing our new design;

FIG. 2 is a front view thereof, the rear view being a mirror image of the view shown;

FIG. 3 is a bottom view thereof;

FIG. 4 is a left side view thereof;

FIG. 5 is a right side view thereof;

FIG. 6 is a perspective view thereof; and,

FIG. 7 is a perspective view thereof on a reduced scale showing the entire solid-state pressure detector.

1 Claim, 4 Drawing Sheets

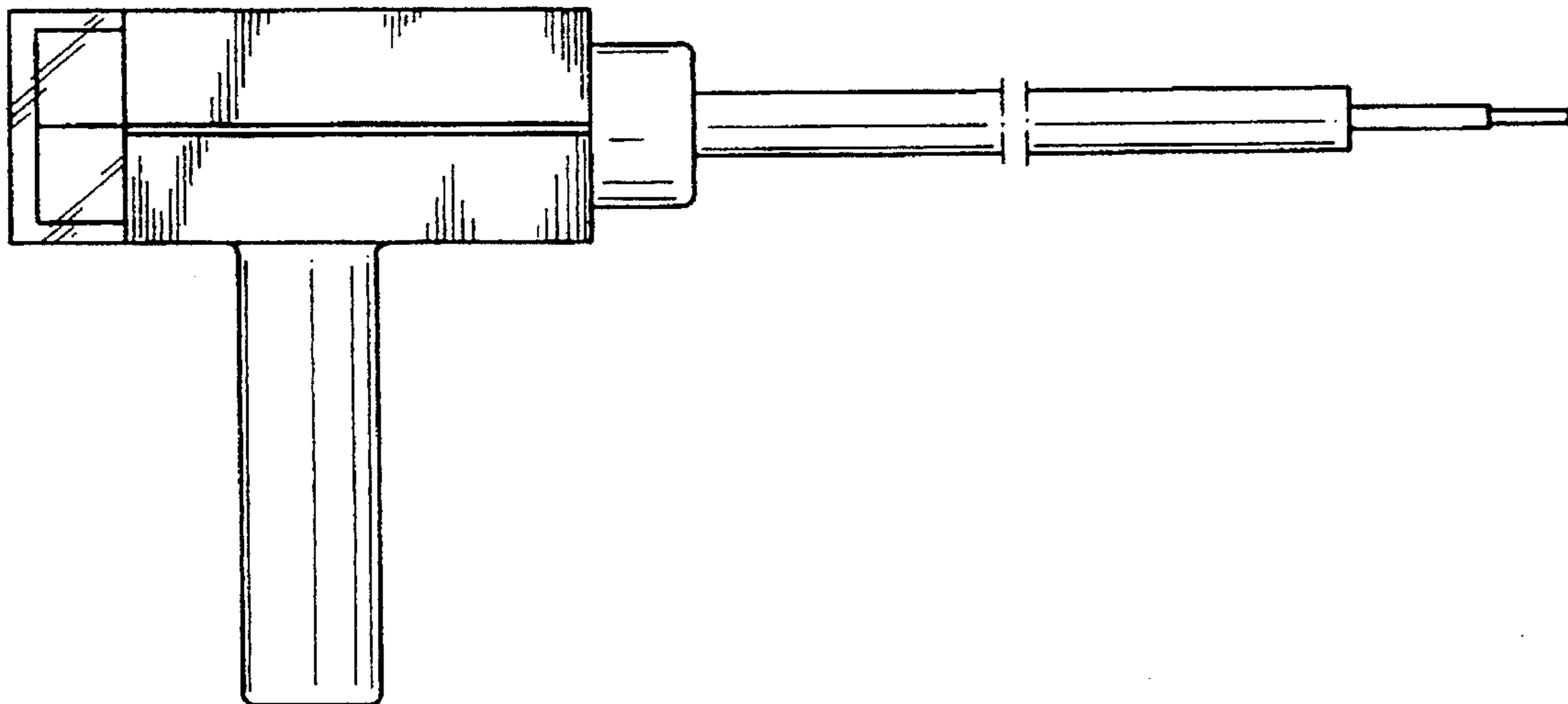

FIG.1

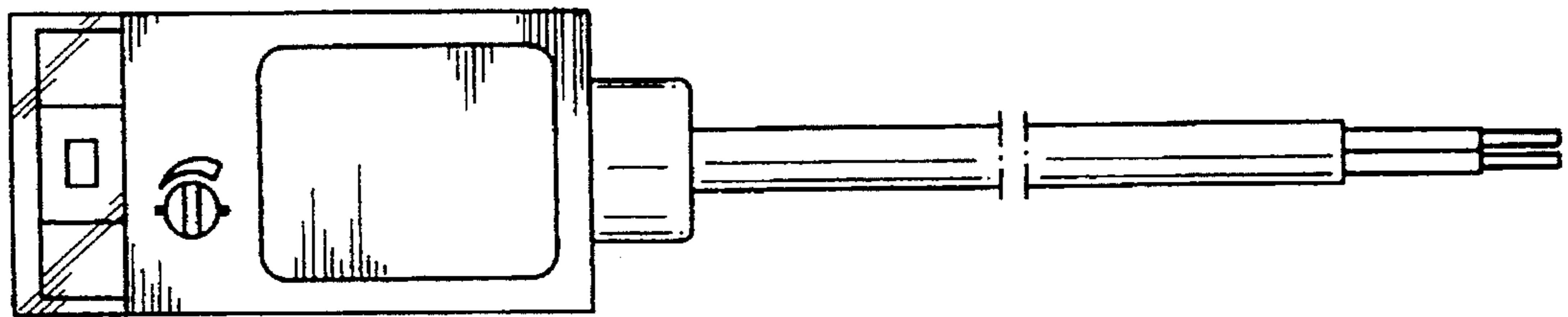

FIG.2

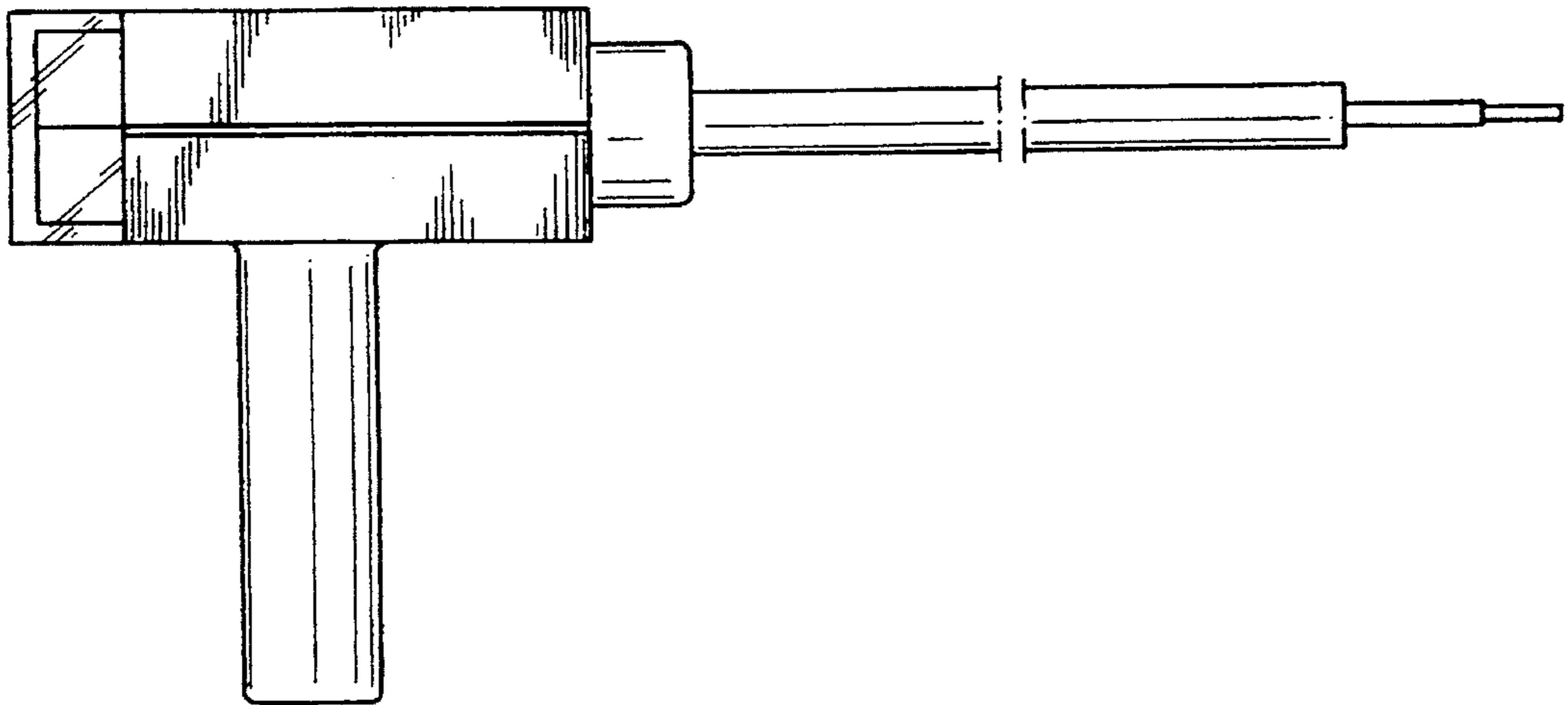

FIG.3

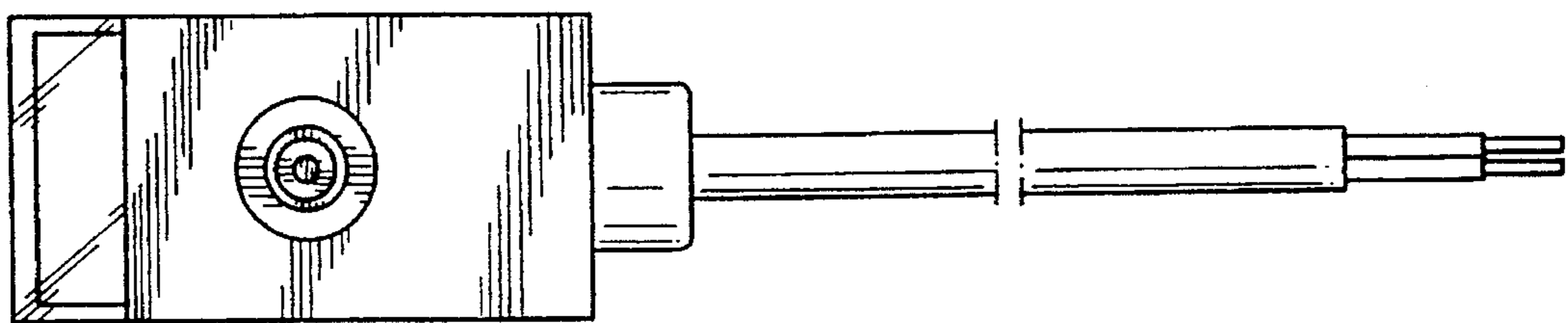

FIG. 4

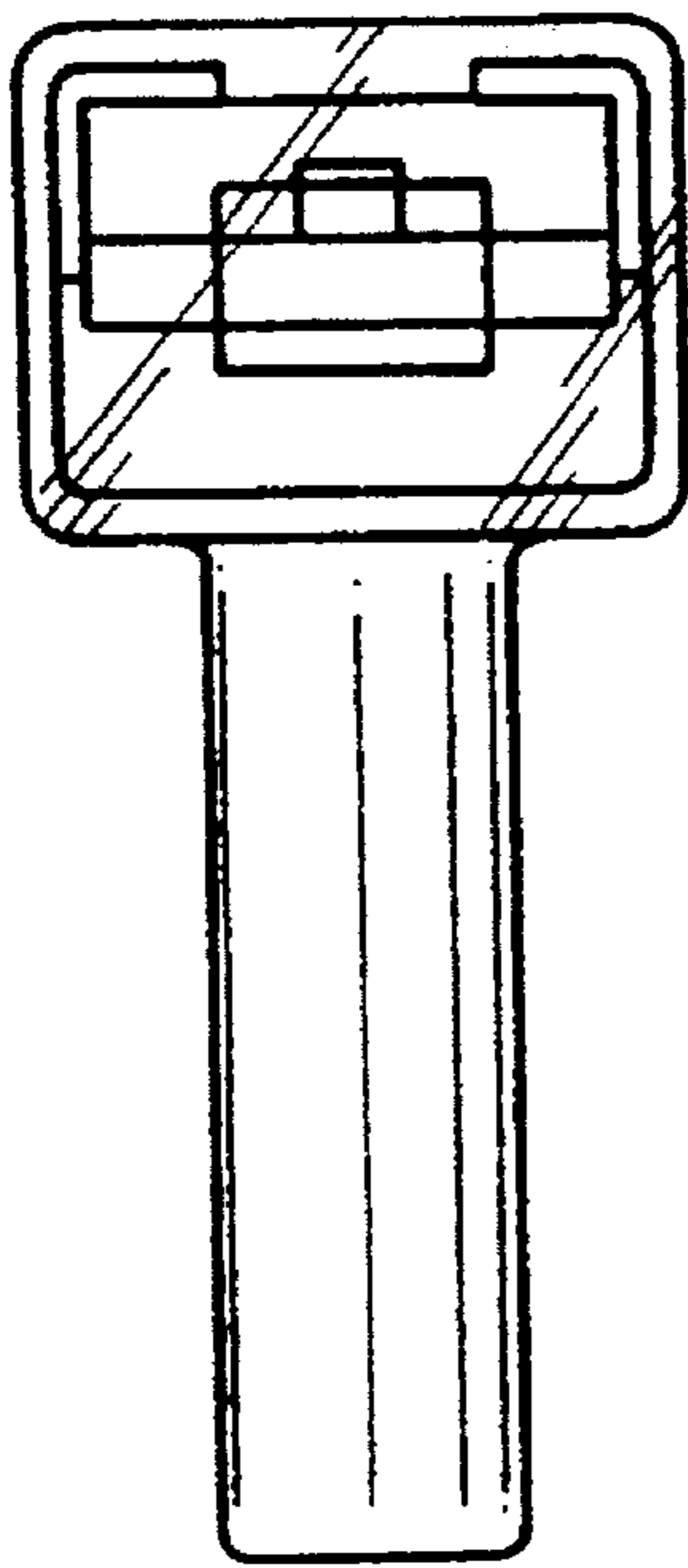

FIG. 5

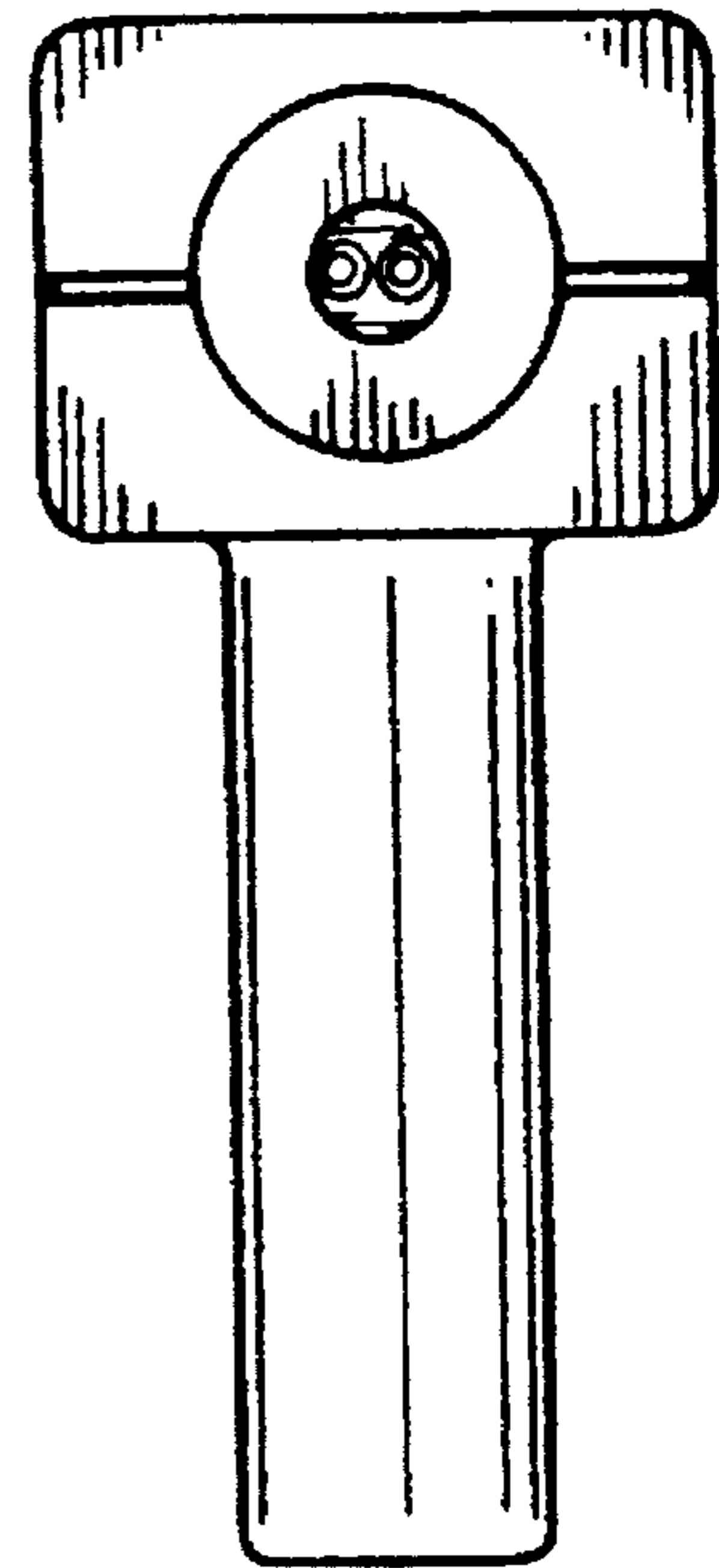
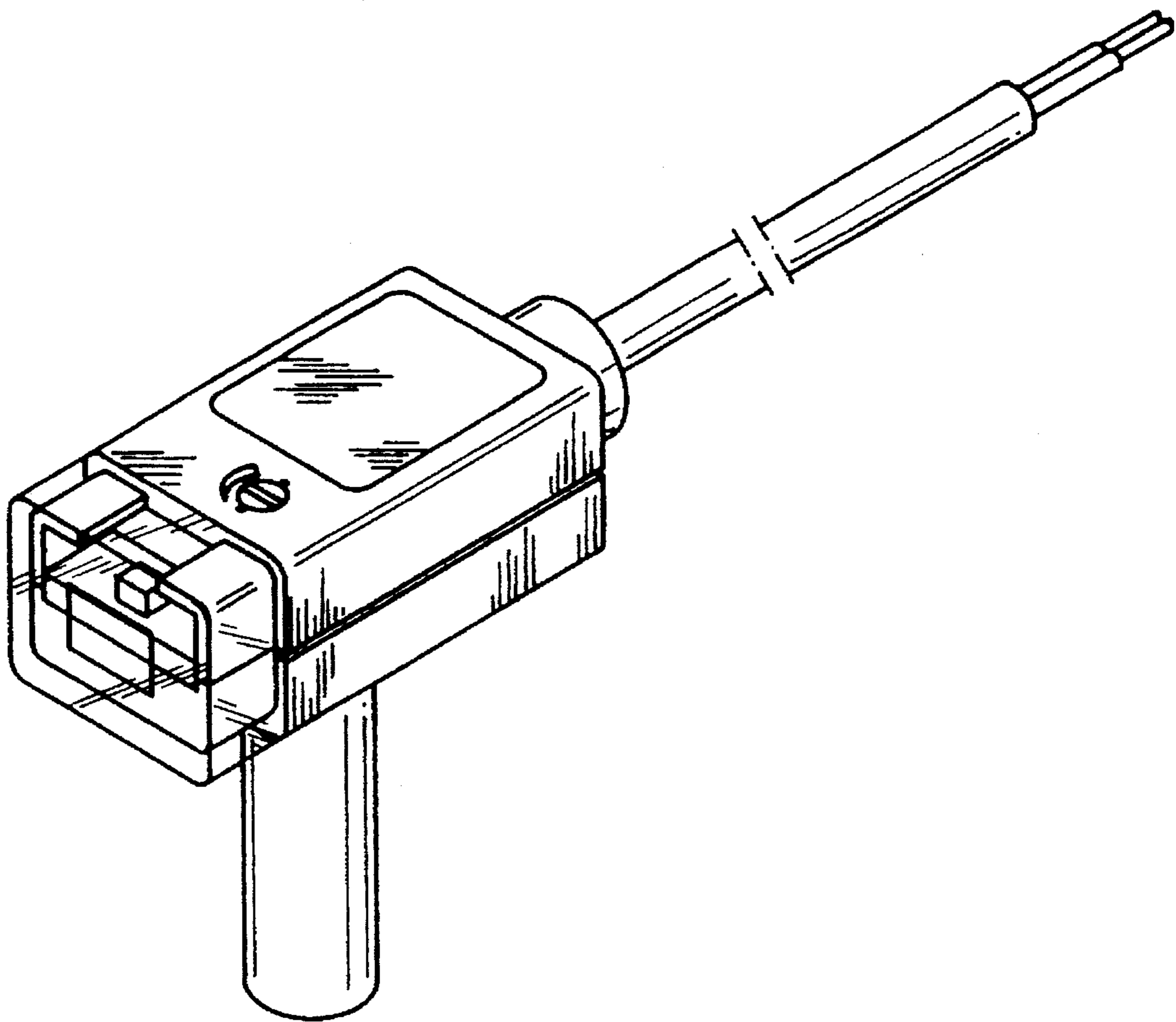

FIG.6



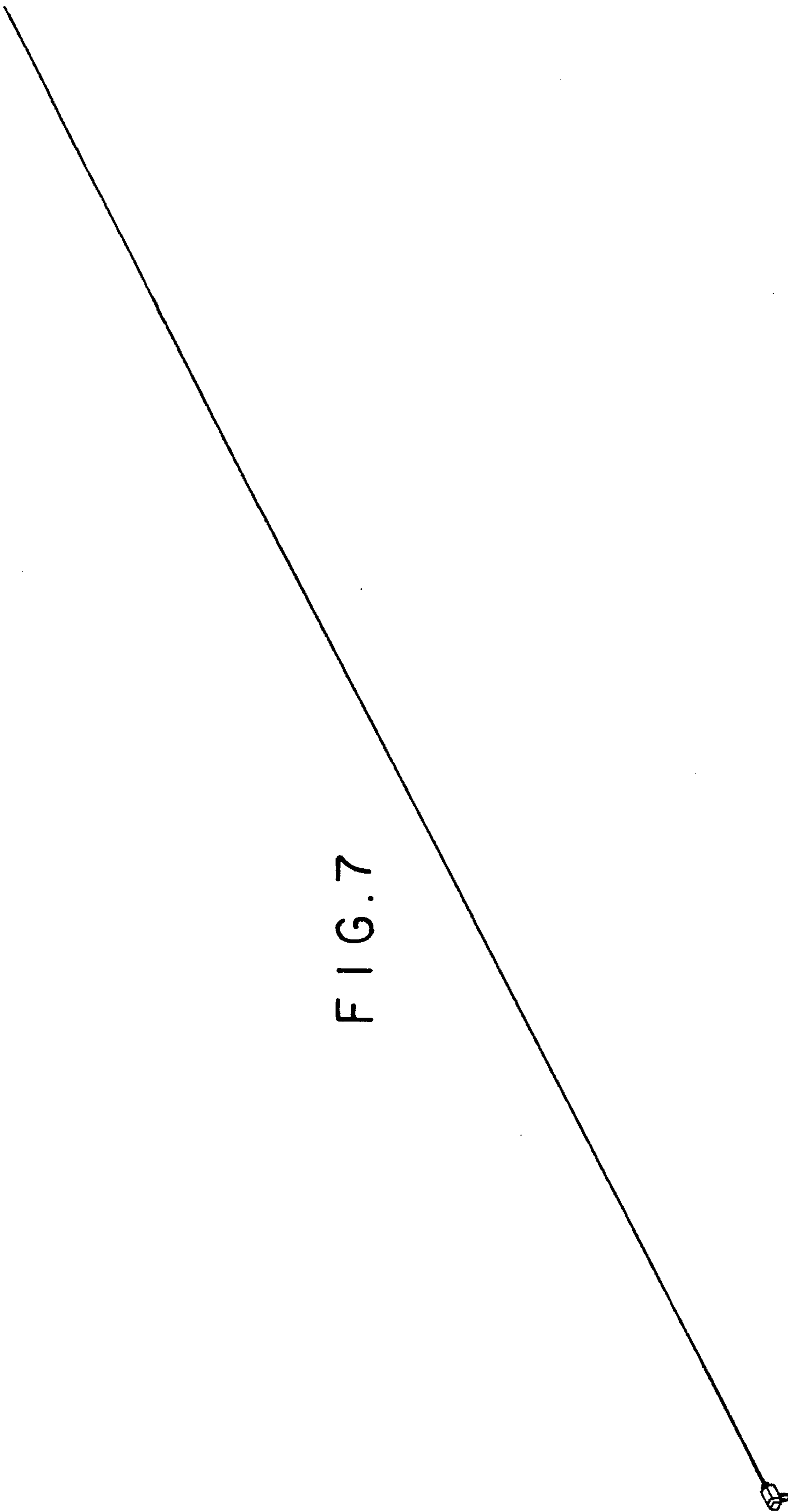

FIG. 7