



US00D373651S

United States Patent [19]

Szymanski

[11] Patent Number: **Des. 373,651**

[45] Date of Patent: ****Sep. 10, 1996**

[54] **FLEXIBLE FLASHLIGHT**

[75] Inventor: **Aaron Szymanski**, Bristol, Conn.

[73] Assignee: **Black & Decker Inc.**, Newark, Del.

[**] Term: **14 Years**

[21] Appl. No.: **36,048**

[22] Filed: **Mar. 13, 1995**

[52] U.S. Cl. **D26/43**

[58] Field of Search D26/37, 43, 44,
D26/46, 49, 60, 62; 362/157, 158, 184,
188, 189, 191, 198, 199, 200, 396

[56] **References Cited**

U.S. PATENT DOCUMENTS

D. 147,258	8/1947	Becker	D26/43
D. 166,073	3/1952	Dunkelberger	D26/43
D. 239,198	3/1976	Nau	D26/46
D. 314,246	1/1991	Bache	D26/62

3,111,277	11/1963	Grimsley	D26/43 X
3,870,843	3/1975	Witte	362/189 X

Primary Examiner—A. Hugo Word
Assistant Examiner—Lavone D. Tabor
Attorney, Agent, or Firm—Barry E. Deutsch

[57] **CLAIM**

The ornamental design for a flexible flashlight, as shown and described.

DESCRIPTION

FIG. 1 is a perspective view taken from the front, top and right side of a flexible flashlight showing my new design; FIG. 2 is a right side elevational view thereof; FIG. 3 is a left side elevational view thereof; FIG. 4 is a front elevational view thereof; FIG. 5 is a rear elevational view thereof; FIG. 6 is a top plan view thereof; and, FIG. 7 is a bottom plan view thereof.

1 Claim, 3 Drawing Sheets

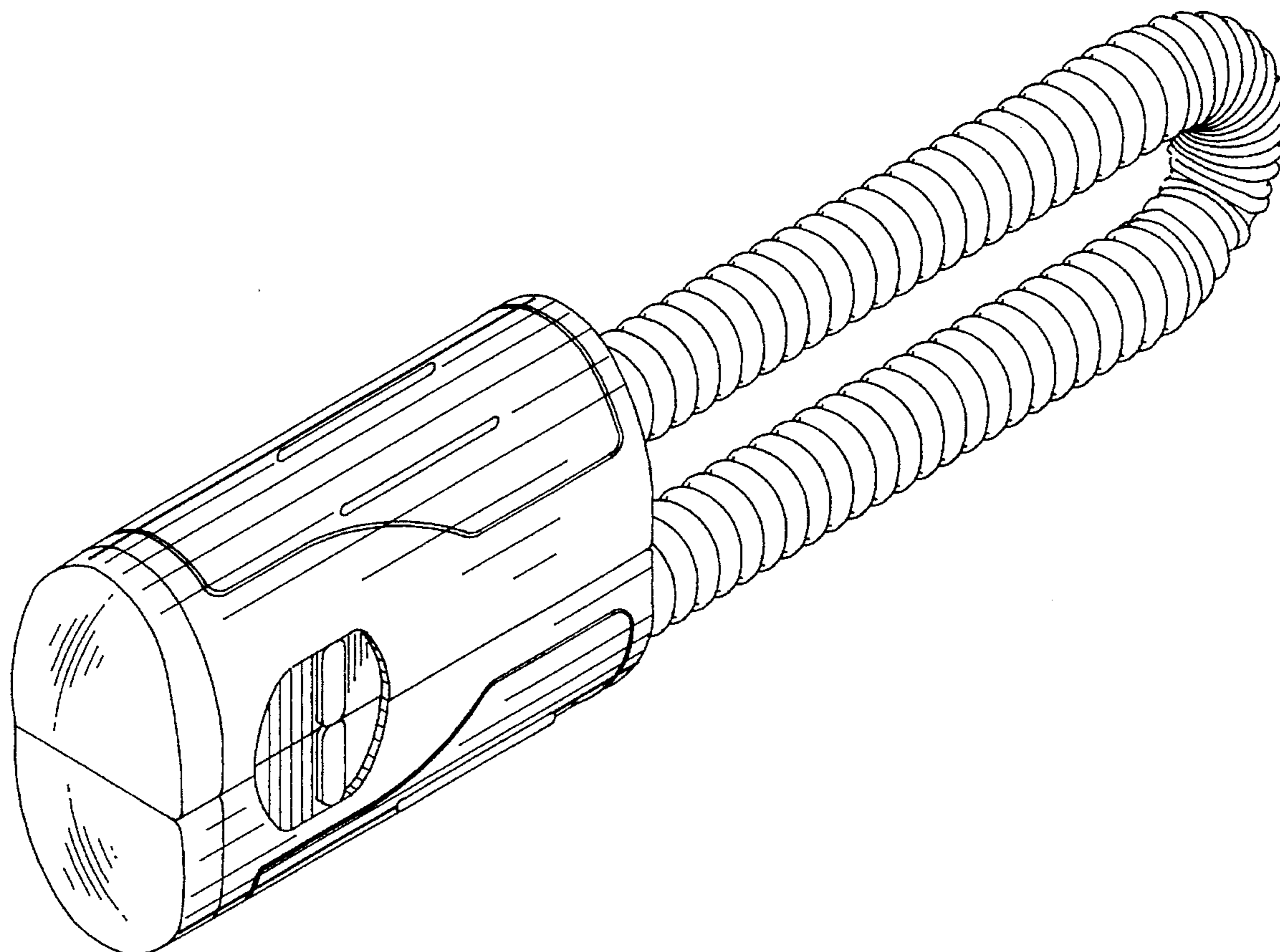

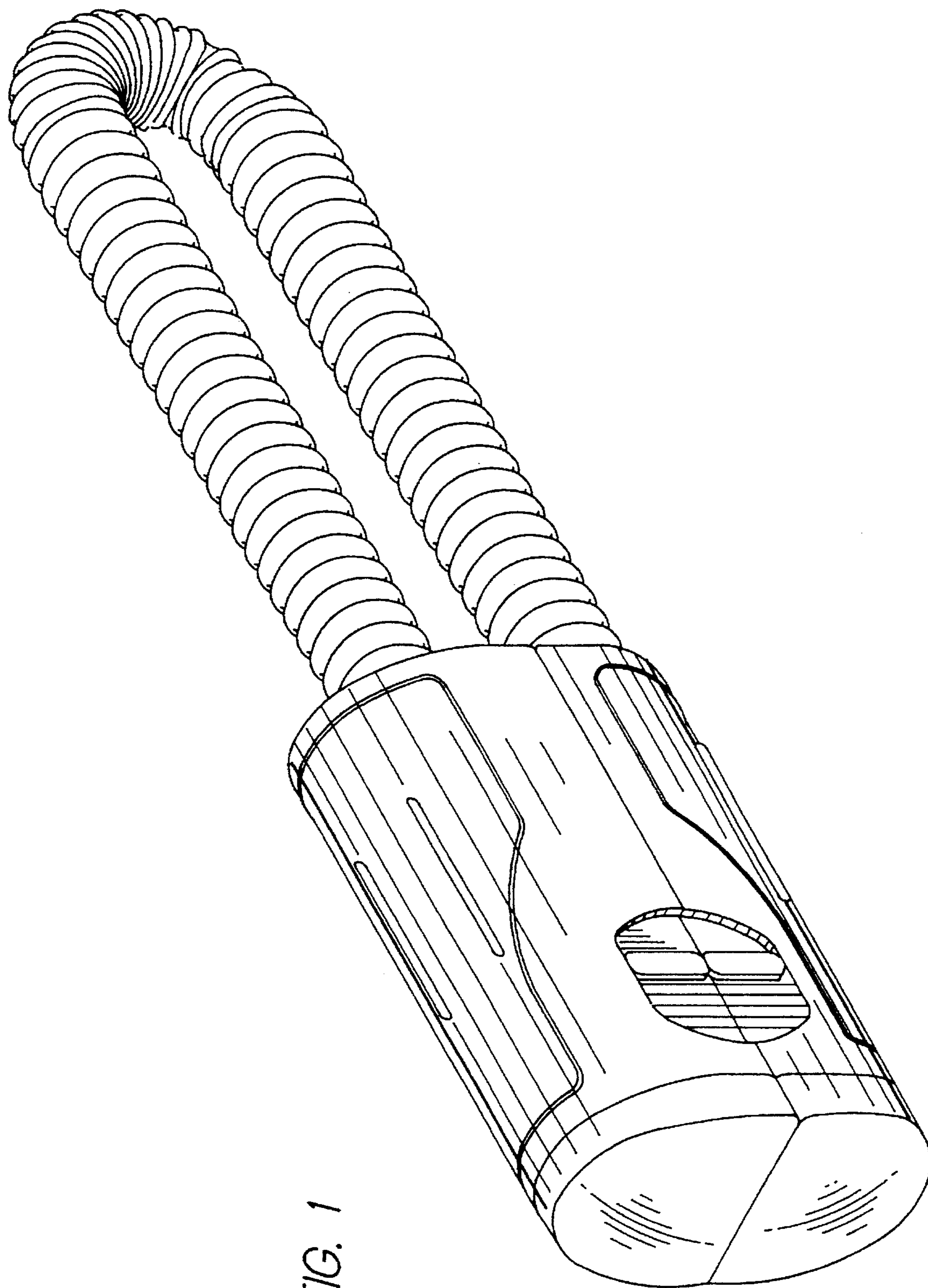

FIG. 1

FIG. 2

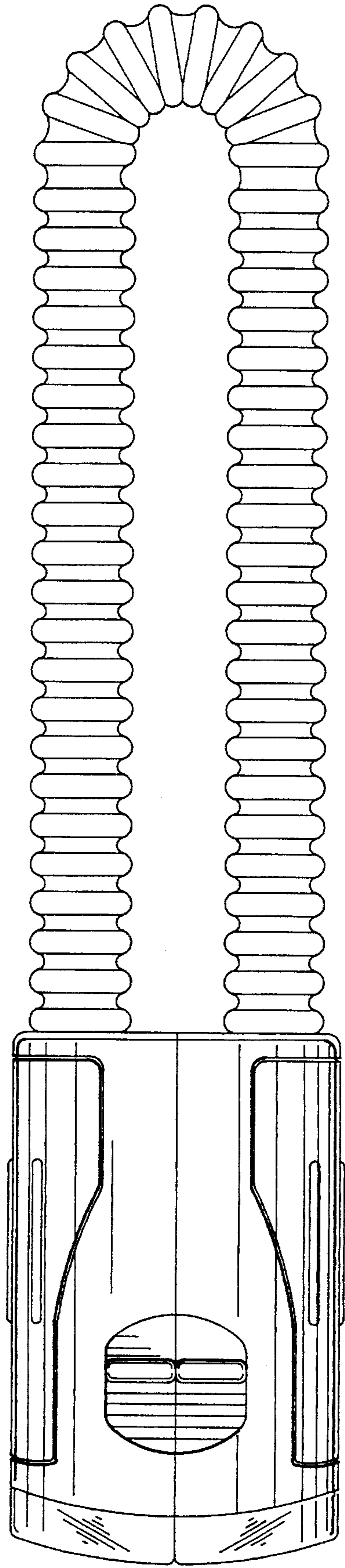

FIG. 3

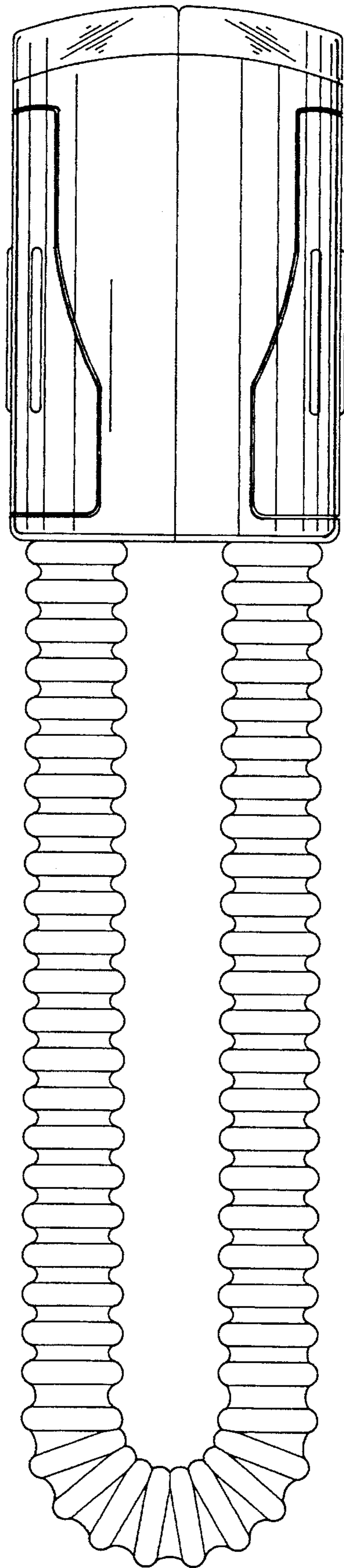

FIG. 5

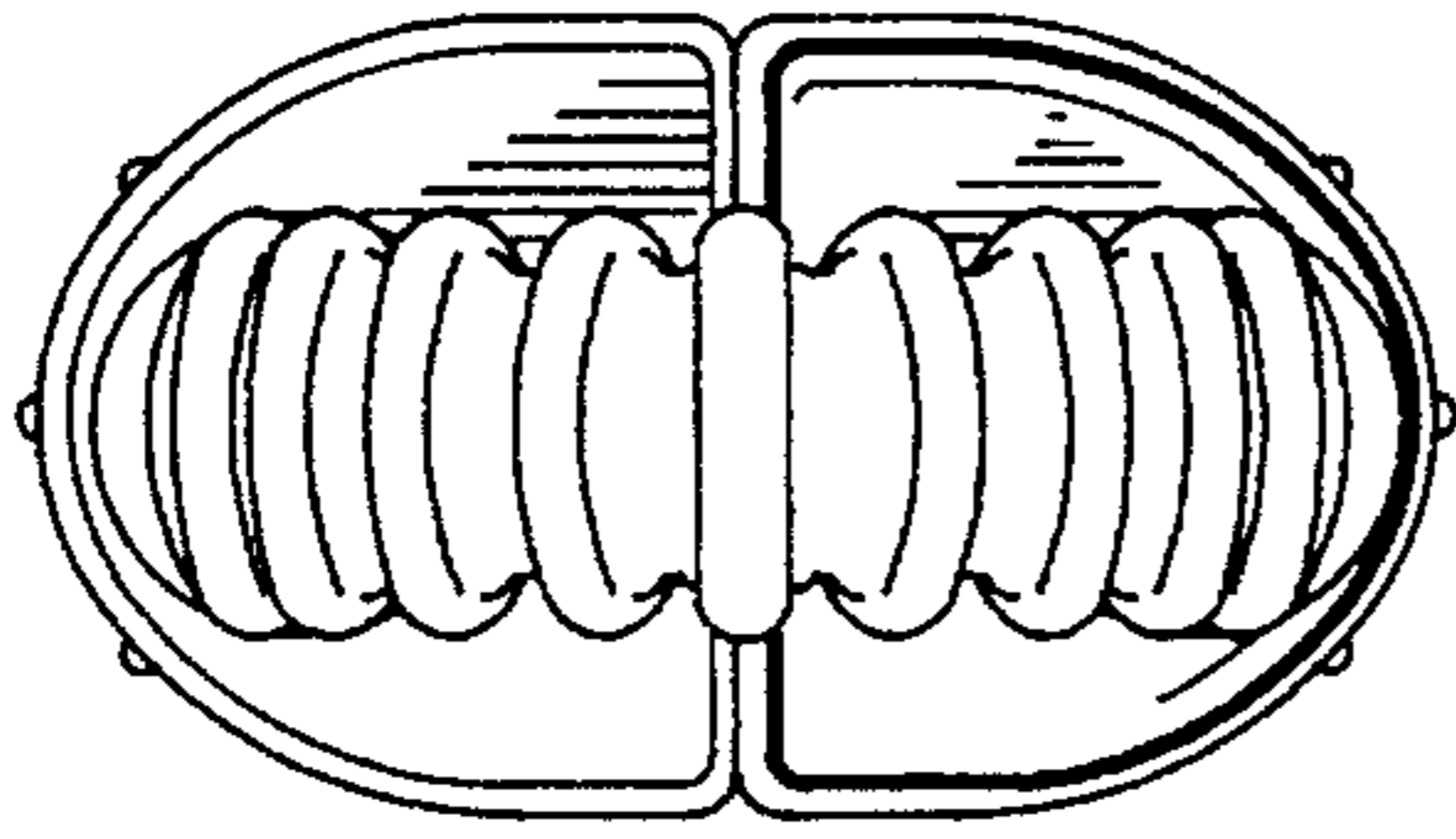

FIG. 4

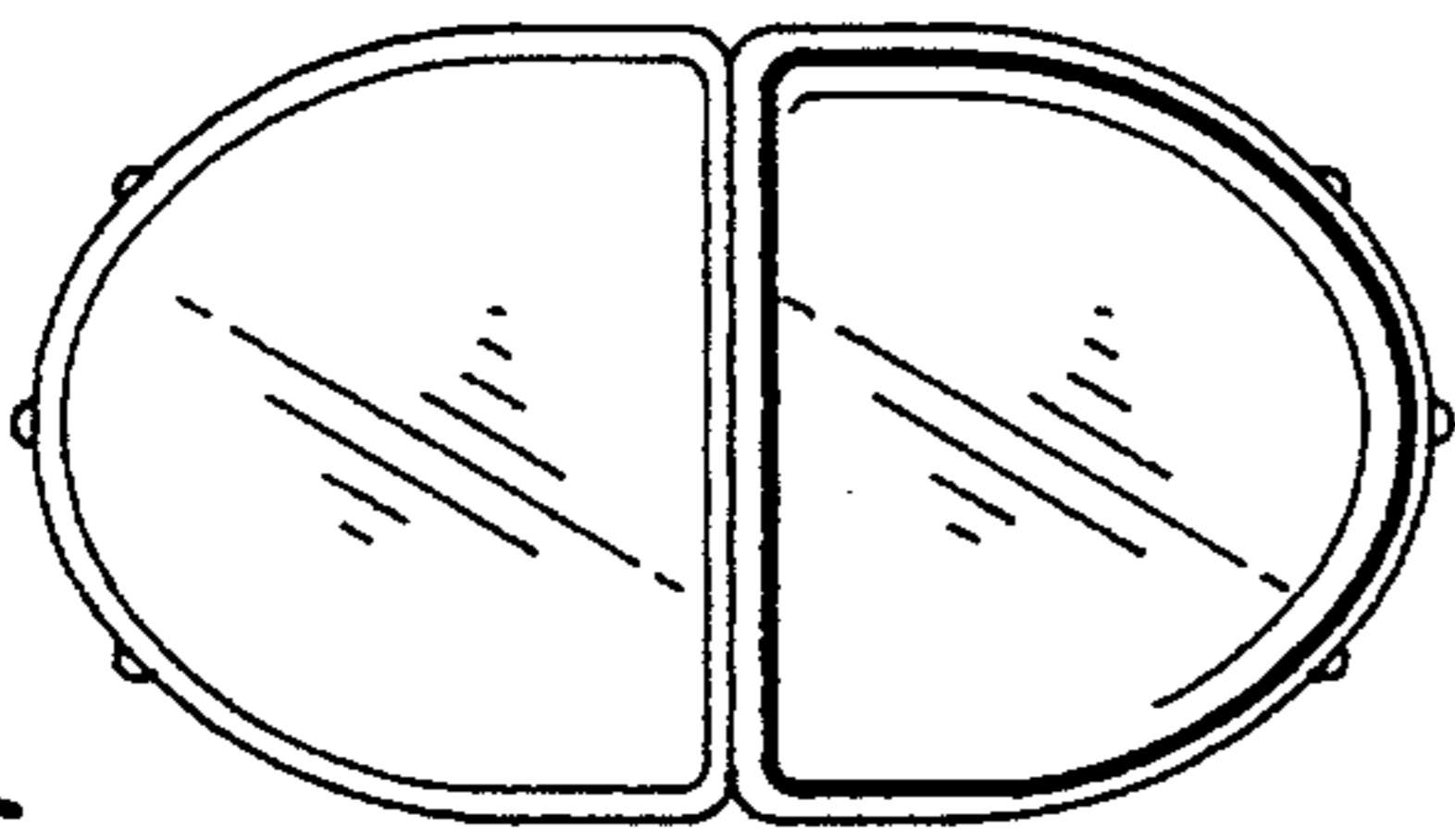

FIG. 6

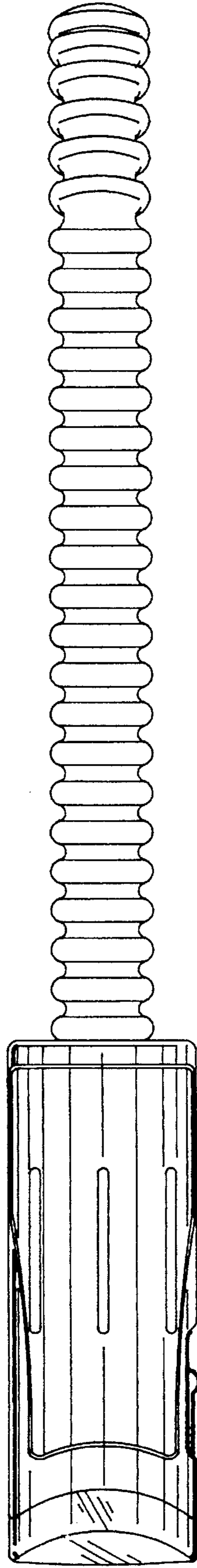

FIG. 7

