



US00D373649S

United States Patent [19]

Carbone

[11] Patent Number: **Des. 373,649**

[45] Date of Patent: ****Sep. 10, 1996**

[54] HEAD FOR A FLASHLIGHT

3,124,306 3/1964 Schotz 362/157

[75] Inventor: **Richard J. Carbone**, Southbury, Conn.

Primary Examiner—A. Hugo Word

Assistant Examiner—Lavone D. Tabor

Attorney, Agent, or Firm—Barry E. Deutsch

[73] Assignee: **Black & Decker Inc.**, Newark, Del.

[**] Term: **14 Years**

[57] CLAIM

The ornamental design for a head for a flashlight, as shown and described.

[21] Appl. No.: **39,118**

[22] Filed: **May 22, 1995**

DESCRIPTION

[52] U.S. Cl. **D26/43**

[58] Field of Search D26/37, 43, 44,
D26/46, 49, 60, 62; 362/157, 158, 184,
188, 189, 191, 198, 200, 202, 362, 396

FIG. 1 is a perspective view taken from the front, top and right side of a head for a flashlight illustrating my new design, the portion shown in phantom is illustrative of a flexible core to which my new design may be attached;

FIG. 2 is a right side elevational view thereof;

FIG. 3 is a left side elevational view thereof;

FIG. 4 is a front elevational view thereof;

FIG. 5 is a rear elevational view thereof;

FIG. 6 is a top plan view thereof; and,

FIG. 7 is a bottom plan view thereof.

The broken lines are for illustrative purposes only and form no part of the claimed design.

[56] References Cited

U.S. PATENT DOCUMENTS

D. 147,258	8/1947	Becker	D26/43
D. 166,073	3/1952	Dunkelberger	D26/43
D. 314,246	1/1991	Bache	D26/62
D. 315,609	3/1991	Garrity	D26/49
D. 323,403	1/1992	Sinrod	D26/38
D. 328,146	7/1992	Sinsteden	D26/49
3,111,277	11/1963	Grimsley	D26/43 X

1 Claim, 3 Drawing Sheets

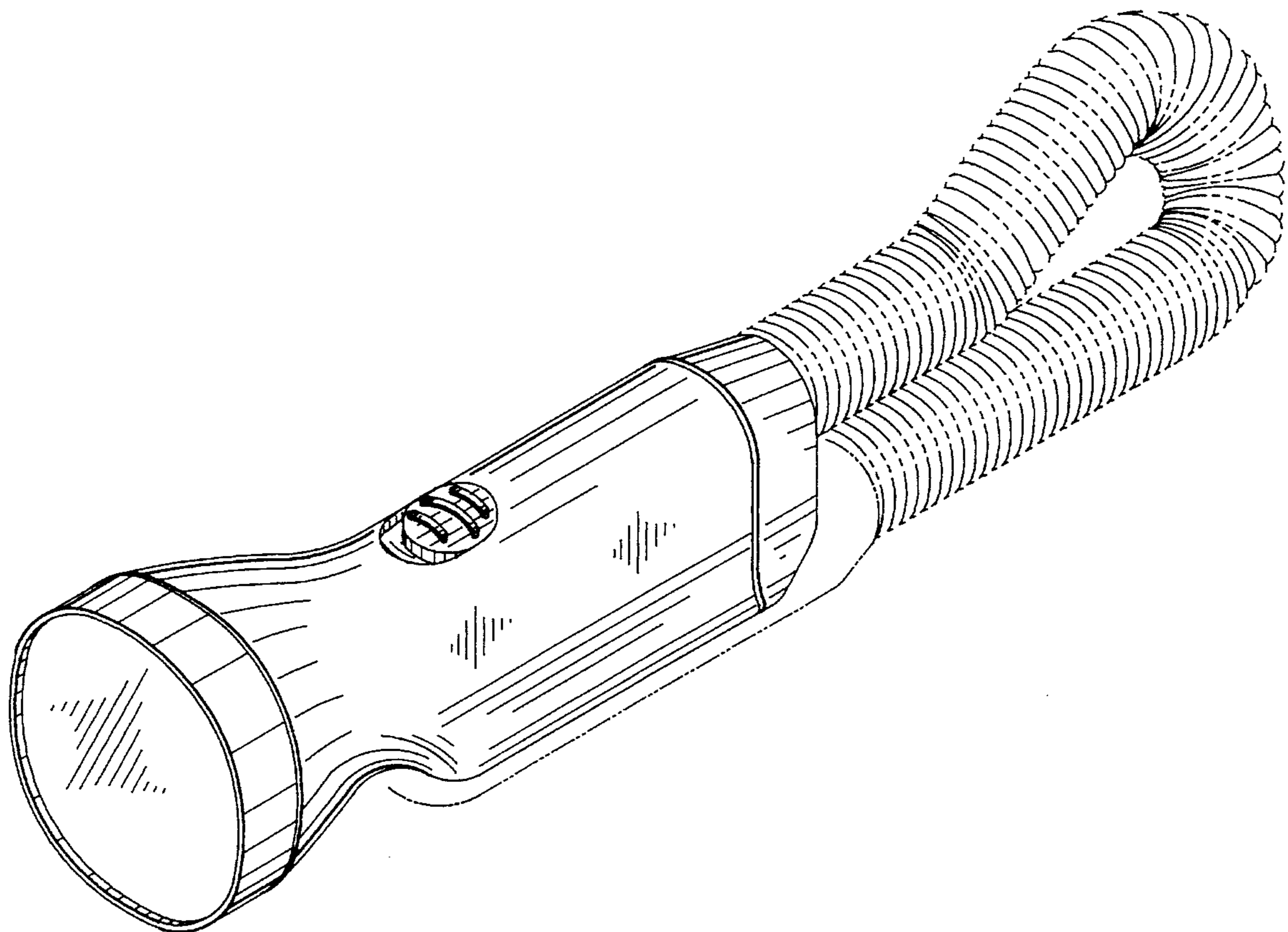

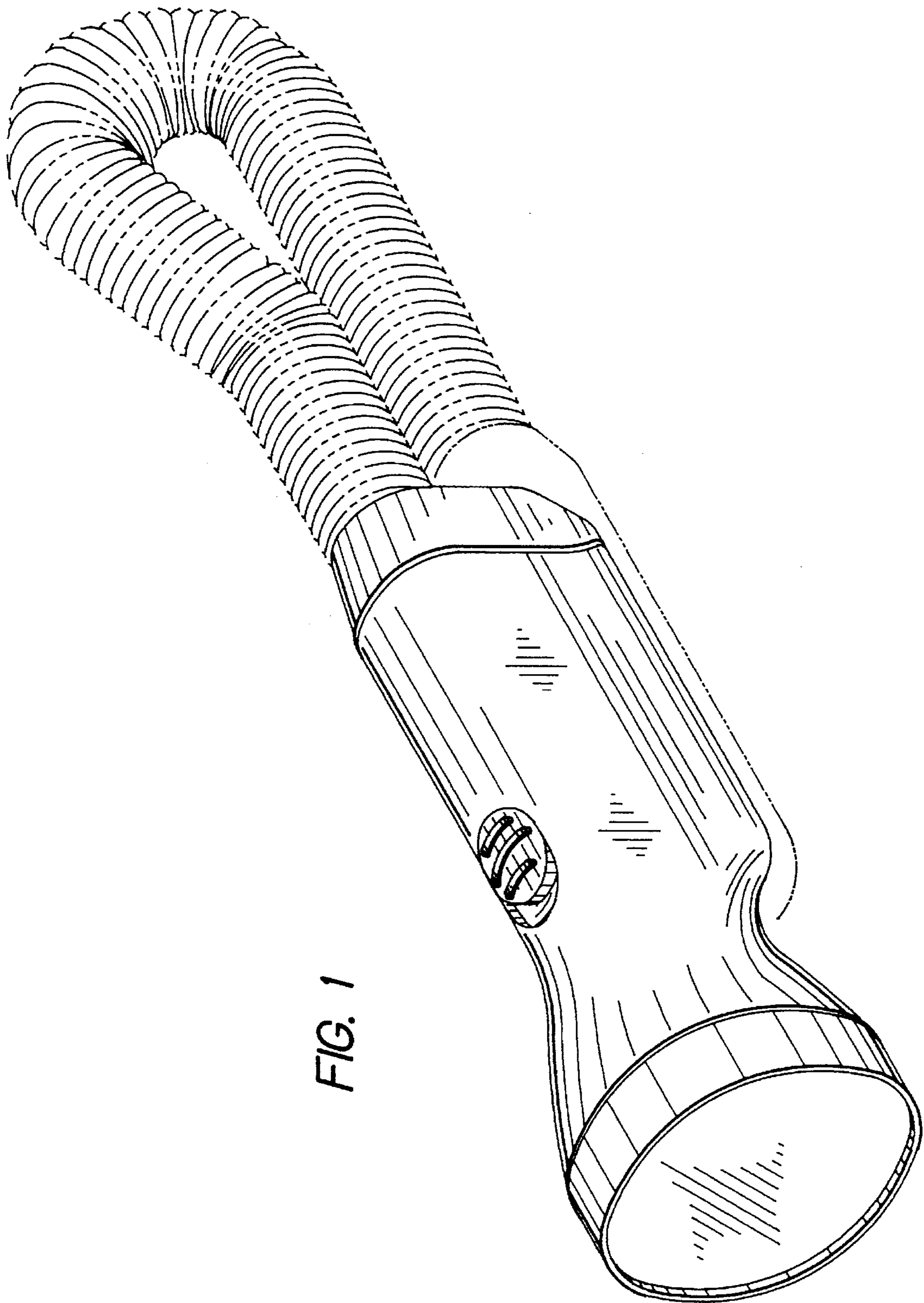

FIG. 2

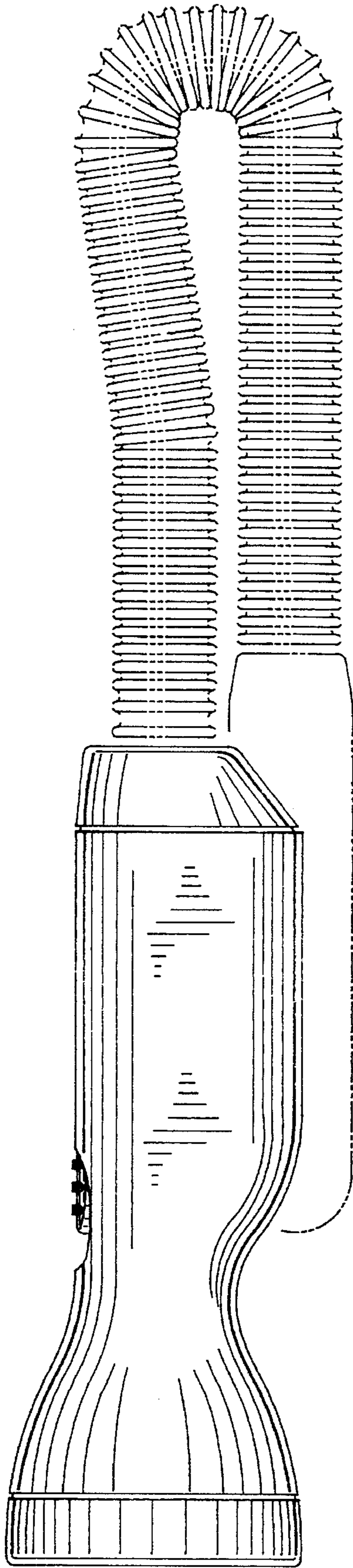

FIG. 3

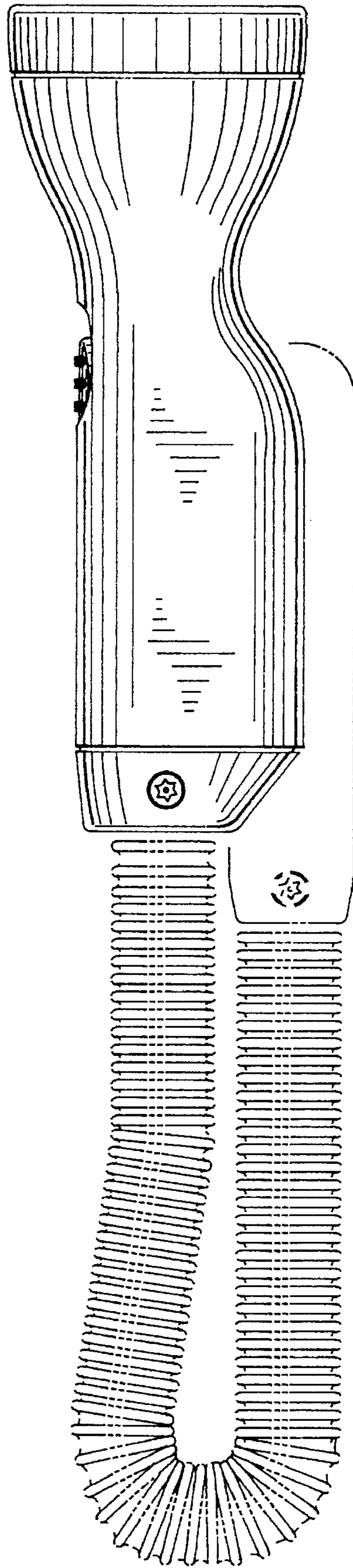

FIG. 5

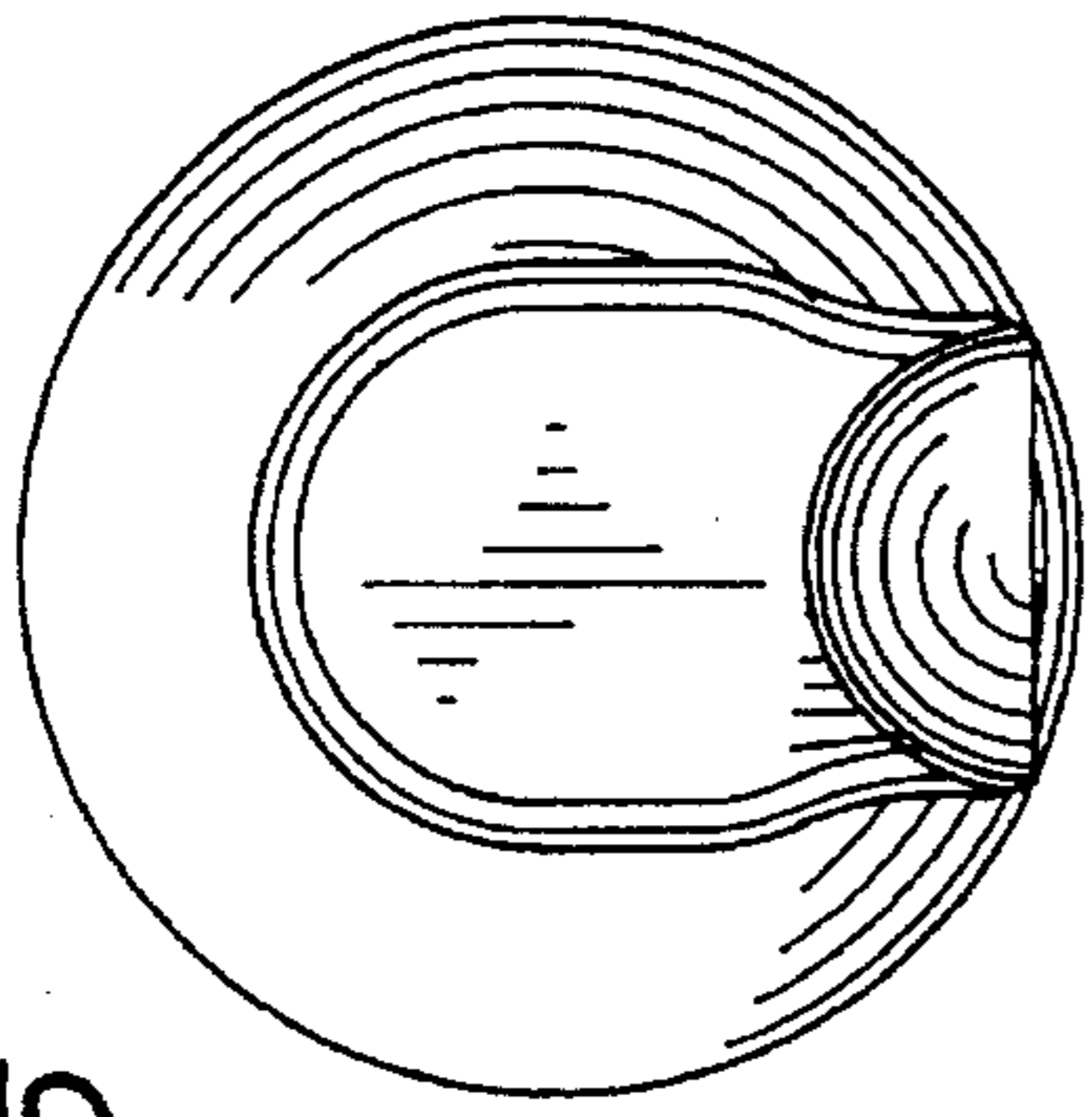

FIG. 4

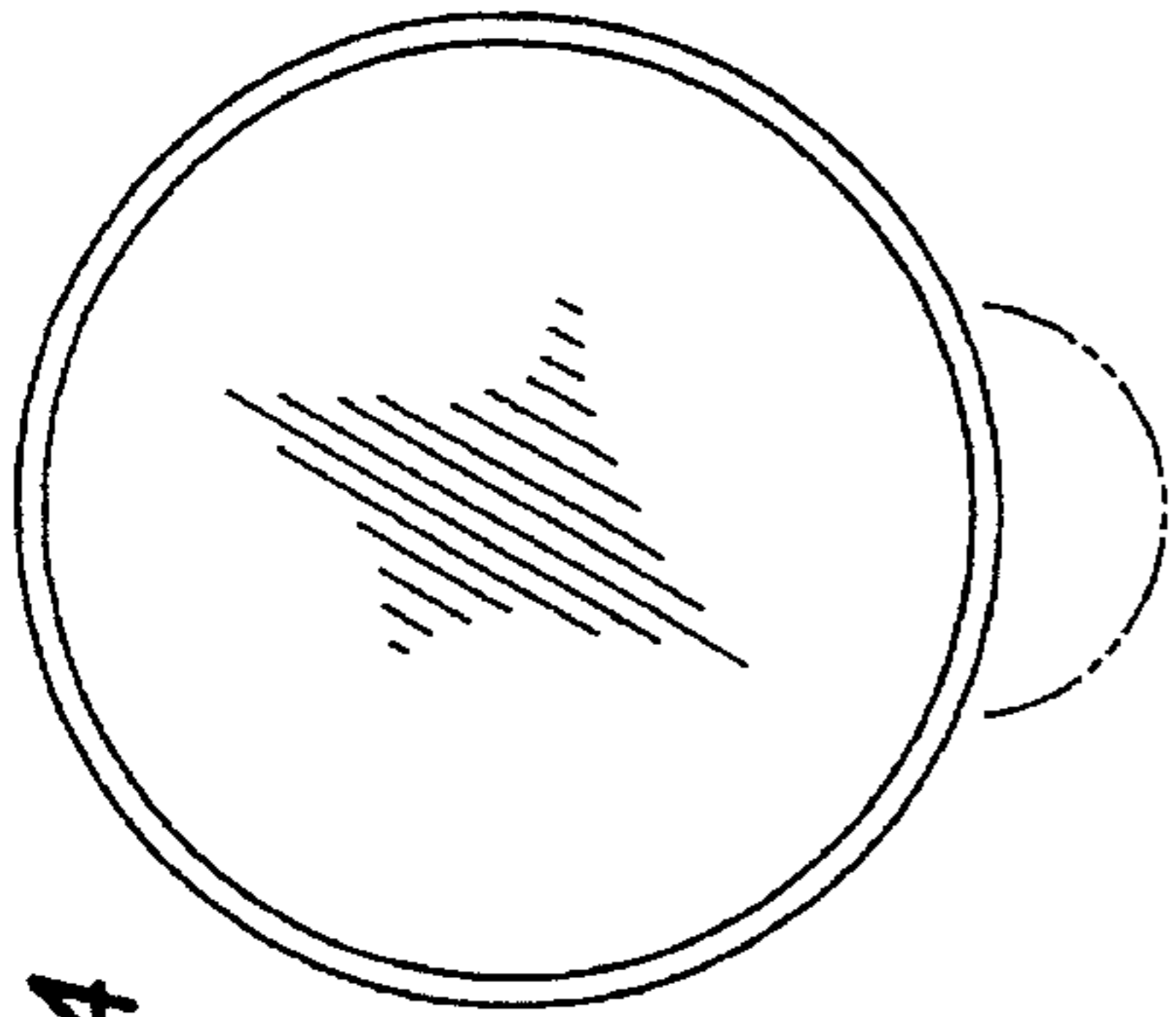

FIG. 6

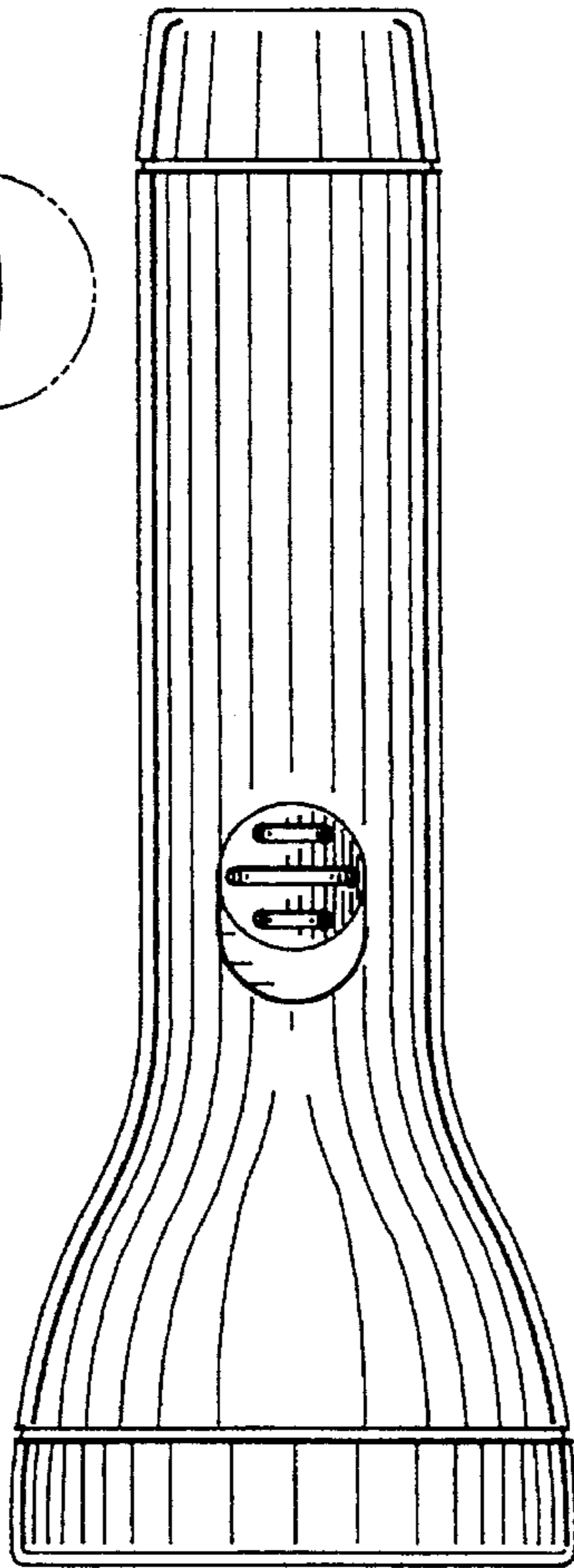

FIG. 7

