



US00D373635S

United States Patent [19]

[11] Patent Number: Des. 373,635

Price et al.

[45] Date of Patent: **Sep. 10, 1996

[54] **EXTERNAL FIXATION CLAMP**

[75] Inventors: **Gregory G. Price**, Warsaw; **Randall N. Allard**, Plymouth, both of Ind.

[73] Assignee: **Zimmer, Inc.**, Warsaw, Ind.

[**] Term: **14 Years**

5,112,331 5/1992 Miletich 606/53
 5,160,335 11/1992 Wagenknecht 606/59
 5,167,661 12/1992 Wagenknecht 606/54
 5,254,119 10/1993 Schreiber 606/96 X
 5,275,598 1/1994 Cook 606/54
 5,320,622 6/1994 Faccivli et al. 606/59 X
 5,443,465 8/1995 Penning 606/54 X
 5,496,319 3/1996 Allard et al. 606/54 X

[21] Appl. No.: **46,435**

[22] Filed: **Nov. 14, 1995**

FOREIGN PATENT DOCUMENTS

2499400 8/1982 France A61B 17/18

Related U.S. Application Data

[62] Division of Ser. No. 26,286, Jun. 27, 1994, Pat. No. Des. 367,531.

[52] U.S. Cl. **D24/140**; D24/133

[58] Field of Search D24/140; 606/59, 606/56, 96, 54

OTHER PUBLICATIONS

Zimmer, Inc.—Brochure—Torus External Fixation System—Lit. No. 97-2613-01 Rev. 1—1993.

Primary Examiner—Louis S. Zarfaz
Assistant Examiner—I. Simmons
Attorney, Agent, or Firm—Margaret L. Geringer

[56] References Cited

U.S. PATENT DOCUMENTS

4,308,863 1/1982 Fischer 128/92 A
 4,365,624 12/1982 Jaquet 128/92 A
 4,535,763 8/1985 Jaquet 128/92 A
 4,620,533 11/1986 Mears 128/92 Z
 4,624,249 11/1986 Alvarez Cambras 128/92 ZK
 4,628,922 12/1986 Dewar 606/50
 4,757,809 7/1988 Koeneman et al. 606/96 X
 4,768,524 9/1988 Hardy 128/92 Z
 4,784,125 11/1988 Monticelli et al. 128/92 Z
 4,889,111 12/1989 Ben-Dov 128/419 F
 4,923,458 5/1990 Fischer 606/59
 4,936,843 6/1990 Sohngen 606/54
 4,941,481 7/1990 Wagenknecht 606/59
 5,021,054 6/1991 Monfardini et al. 606/54
 5,067,954 11/1991 Ilizarov 606/58
 5,087,258 2/1992 Schewior 606/56
 5,095,919 3/1992 Monticelli et al. 606/56
 5,098,432 3/1992 Wagenknecht 606/54

[57] CLAIM

The ornamental design for an external fixation clamp, as shown and described.

DESCRIPTION

FIG. 1 is a perspective view of an external fixation clamp; FIG. 2 is an end view thereof; FIG. 3 is an end view thereof of the end opposite the end shown in FIG. 2; FIG. 4 is a top plan view thereof; FIG. 5 is a bottom plan view thereof; FIG. 6 is a side elevational view thereof; and, FIG. 7 is a side elevational view thereof of the side opposite the side shown in FIG. 6.

The broken line showing of the set screws in FIGS. 1-7 is for illustrative purposes only and forms no part of the claimed design.

1 Claim, 1 Drawing Sheet

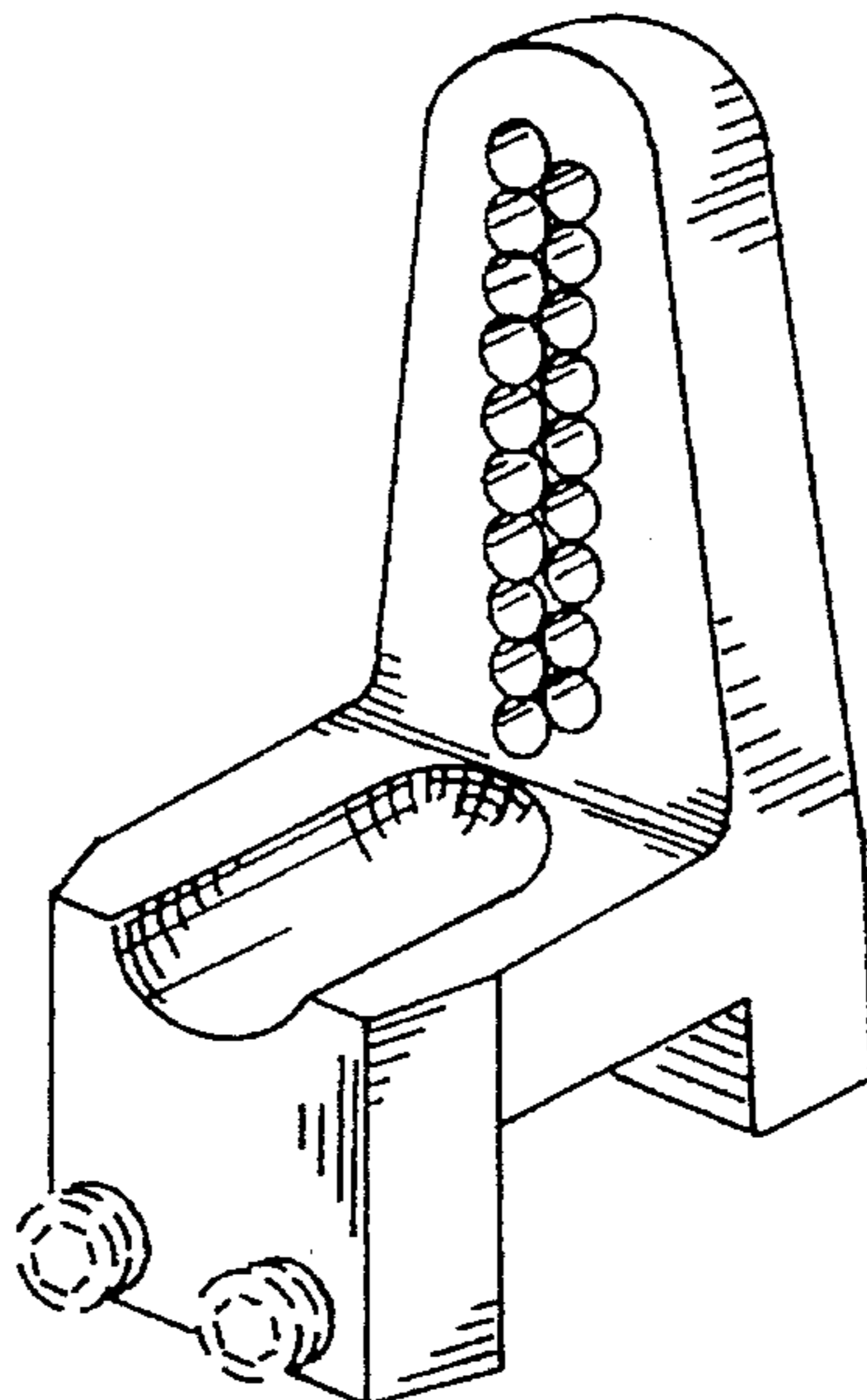

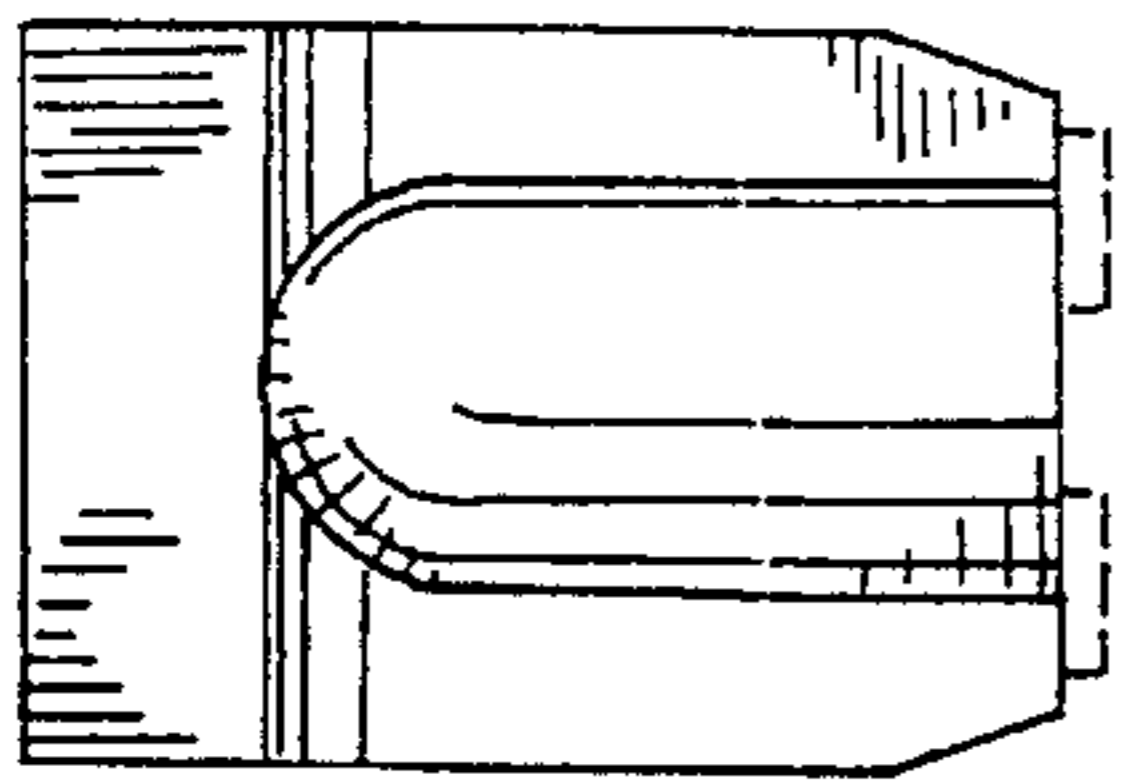

FIG. 4

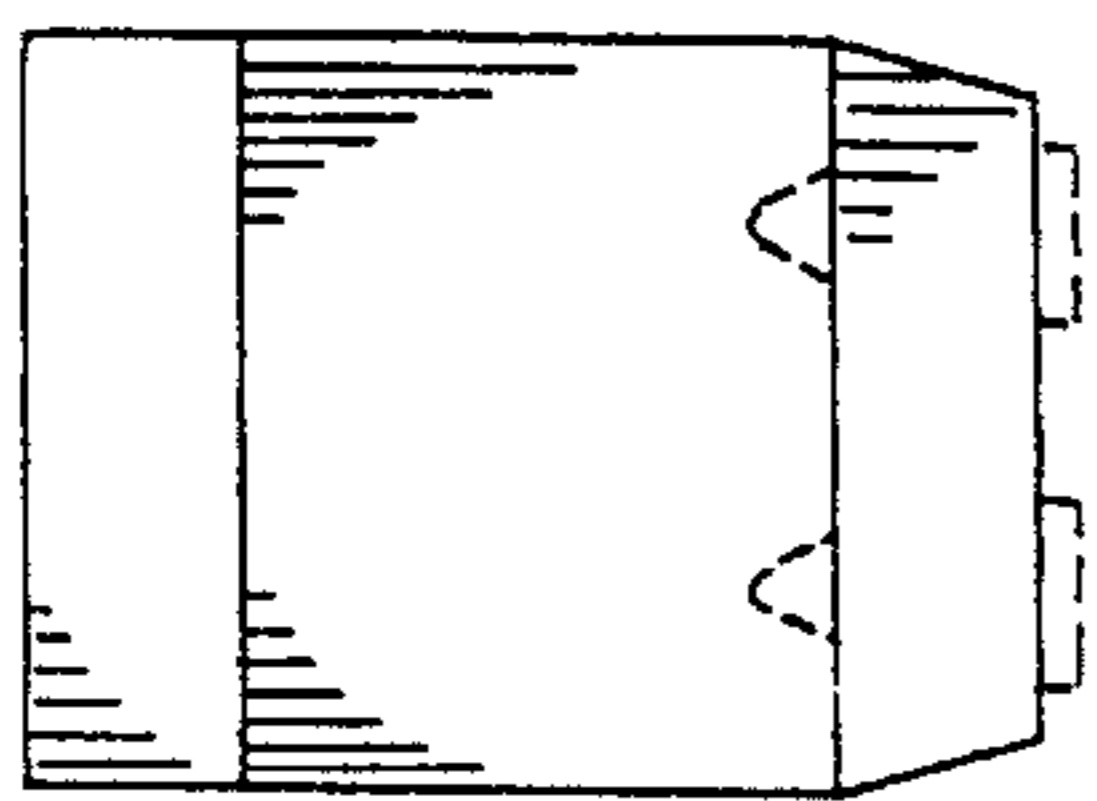

FIG. 5

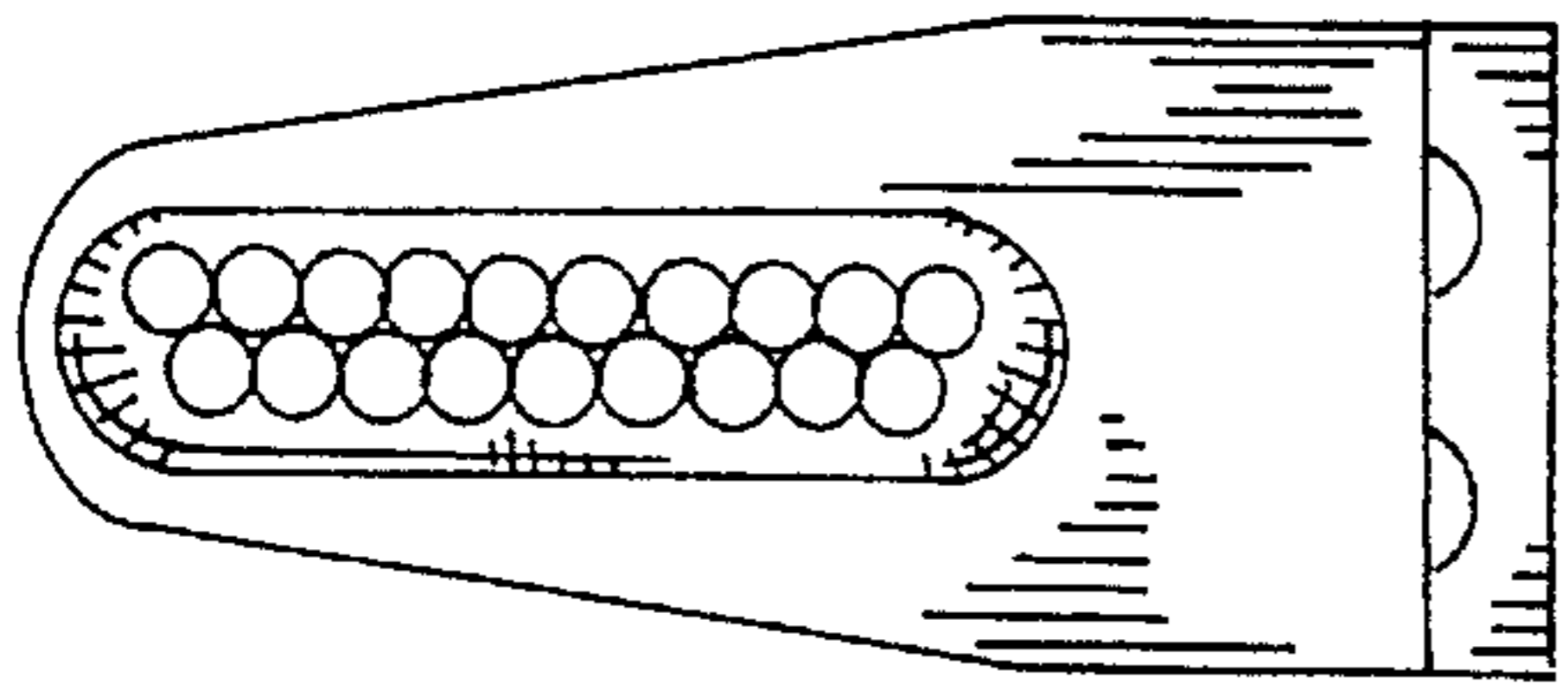

FIG. 3

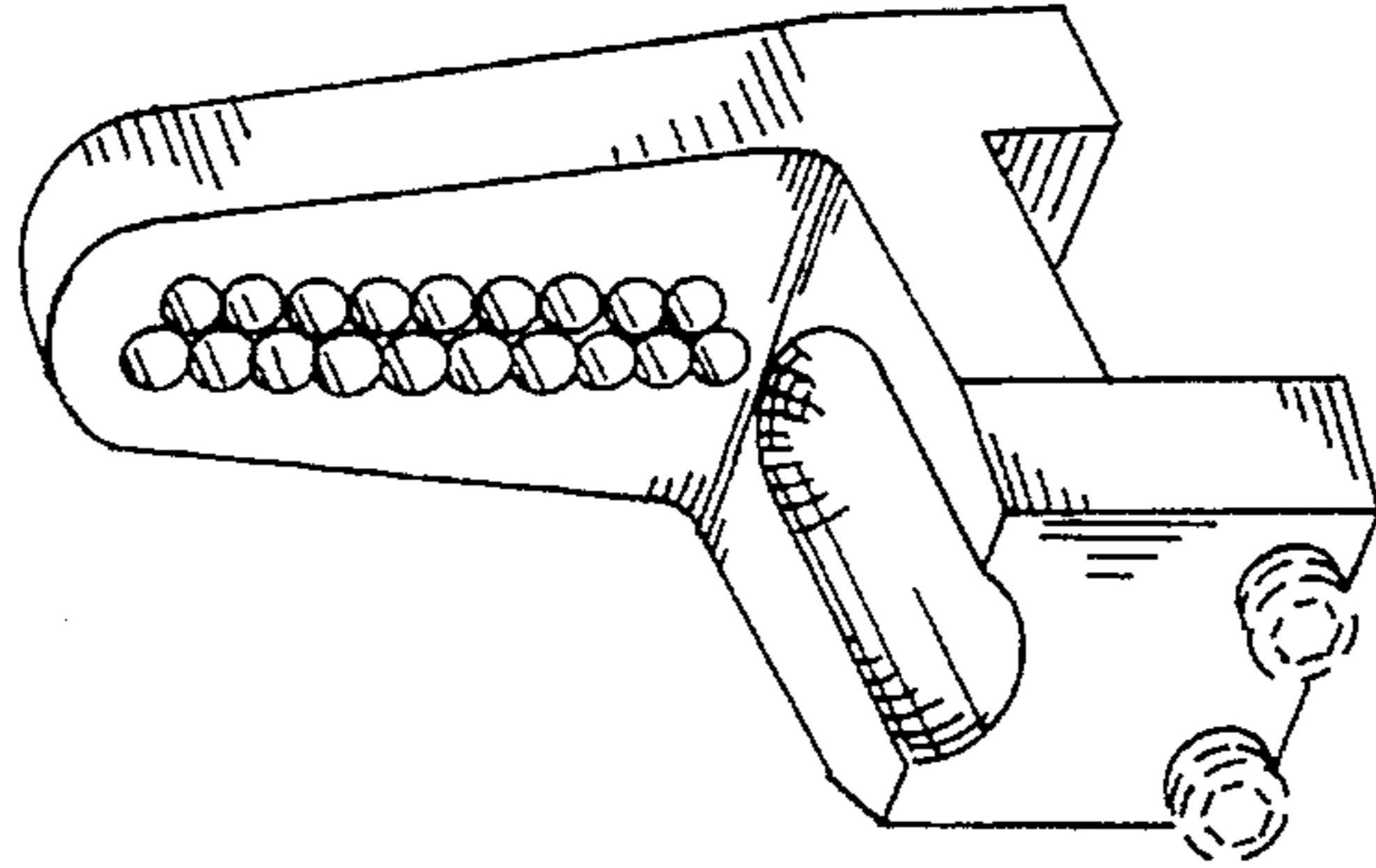

FIG. 1

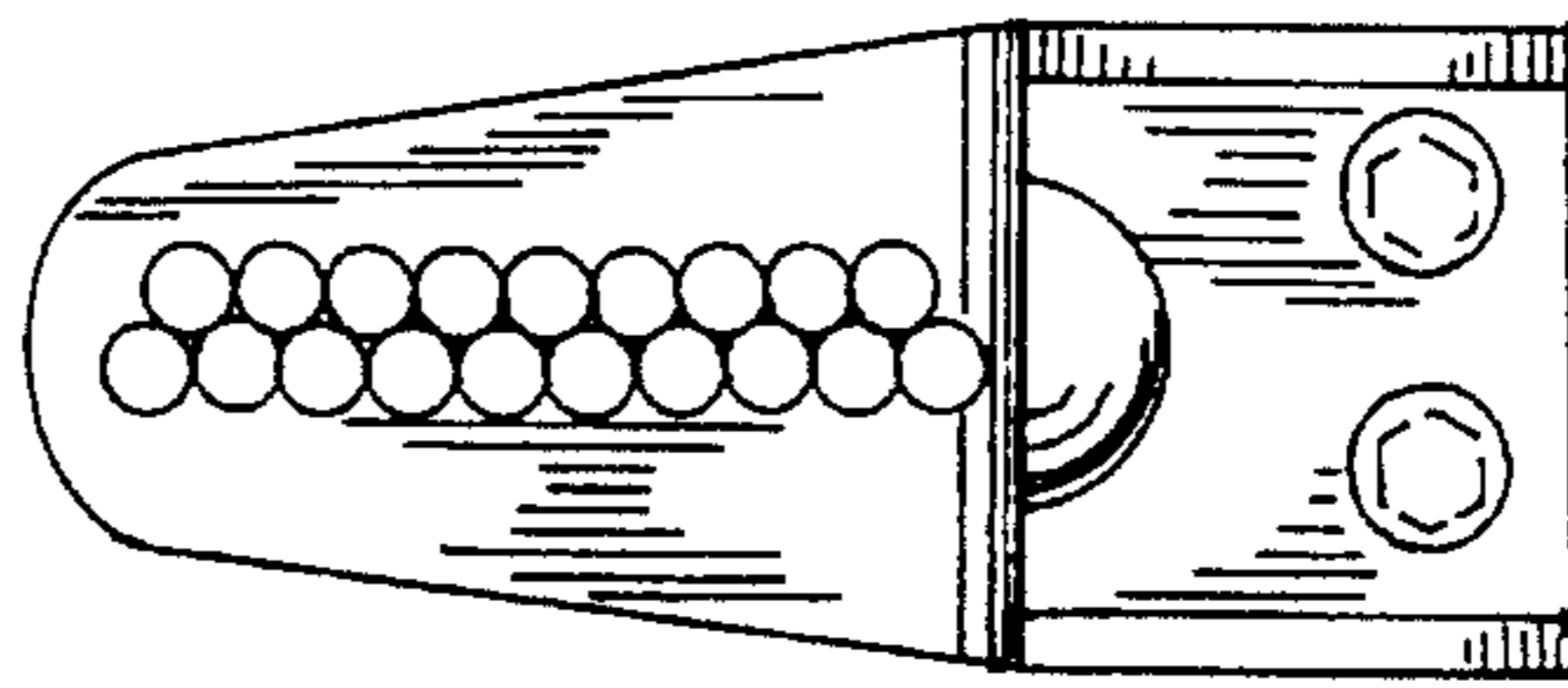

FIG. 2

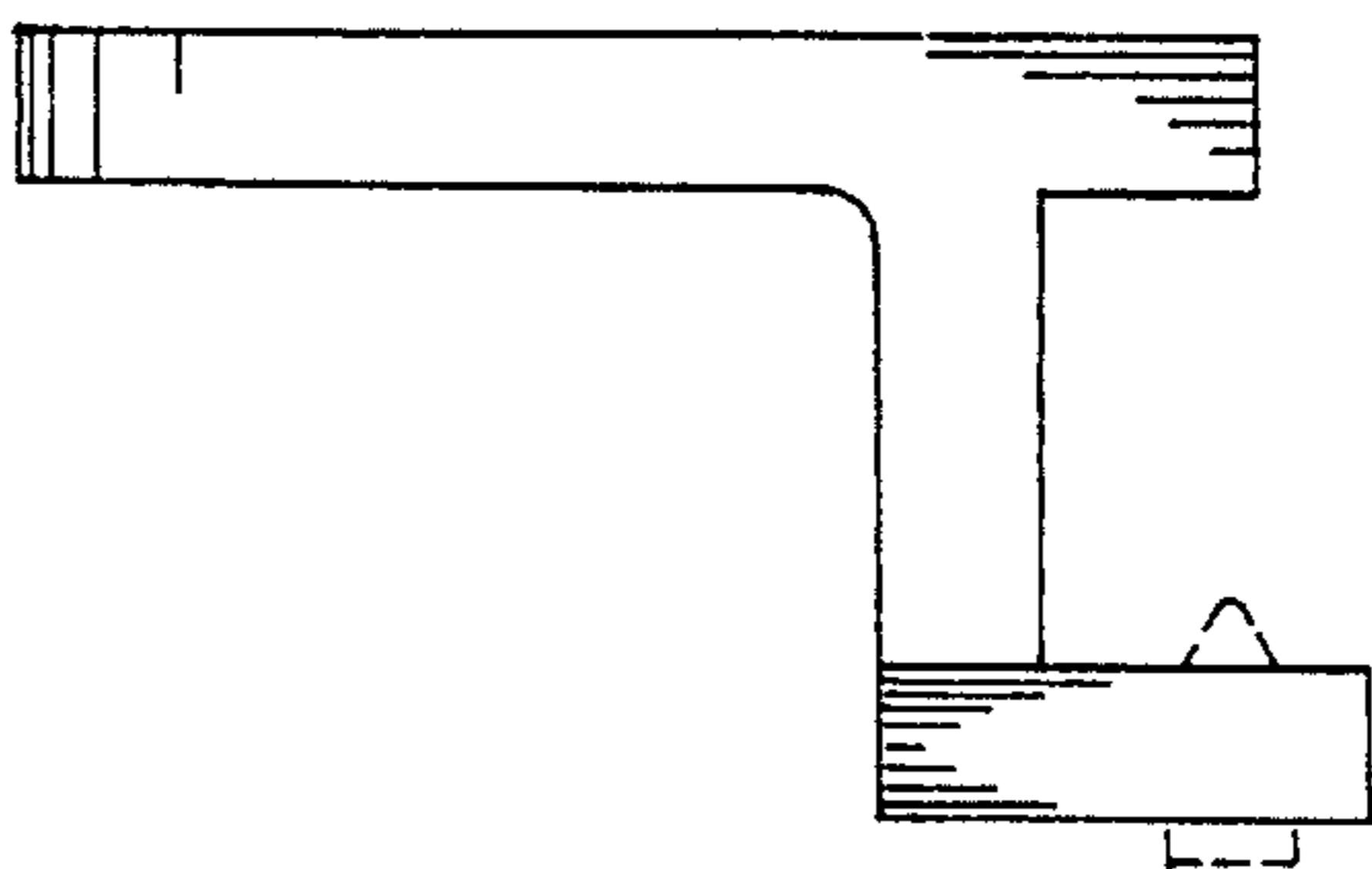

FIG. 6

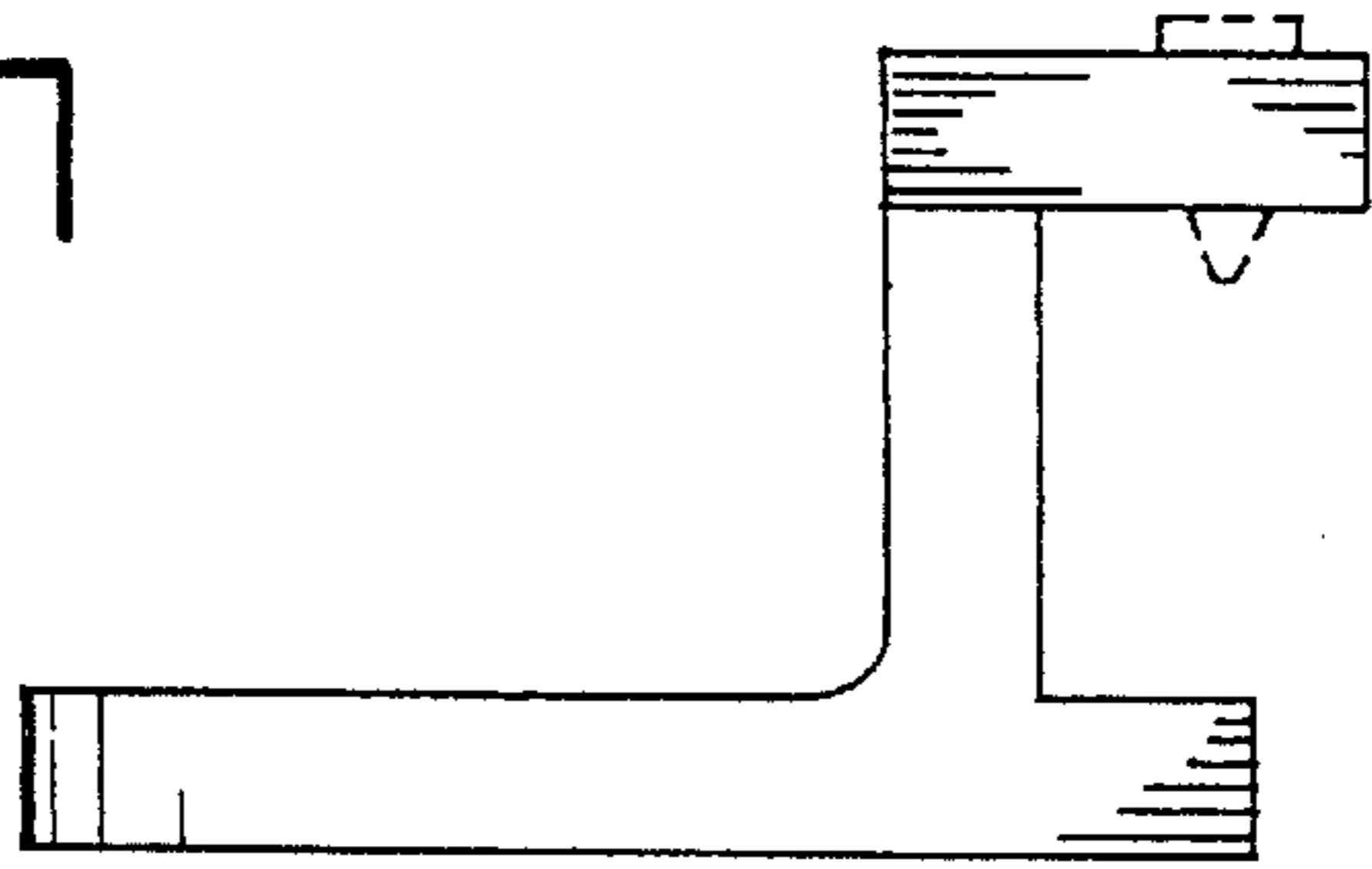

FIG. 7