



US00D373604S

# United States Patent [19]

[11] Patent Number: Des. 373,604

Salansky

[45] Date of Patent: \*\*Sep. 10, 1996

[54] CHESS SET

[76] Inventor: Charles A. Salansky, 194 Voorhees Ave., Buffalo, N.Y. 14214

[\*\*] Term: 14 Years

[21] Appl. No.: 9,952

[22] Filed: Jun. 25, 1993

[52] U.S. Cl. .... D21/52

[58] Field of Search ..... D21/14-36, 48, D21/51, 52; 273/236-288, 289, 290

## [56] References Cited

### U.S. PATENT DOCUMENTS

D. 219,037	10/1970	Laufer	273/288
D. 270,171	8/1983	Janusz	D21/52
D. 272,454	1/1984	Boudreaux	D21/52
D. 312,311	11/1990	Cotton	D21/52
2,835,986	5/1958	Roeder	D21/52

### FOREIGN PATENT DOCUMENTS

323850	1/1930	United Kingdom	D21/52
--------	--------	----------------	--------

### OTHER PUBLICATIONS

- Design*, Oct. 1968 p. 34 Chess Set bottom.
- House Beautiful*, Dec. 1968 Chess Set, top right p. 81.
- Gentleman's Quarterly*, Apr. 1970, p. 120 "Things" Chess Set Hanover House Catalog, p. 55.
- Railway Locomotives Cars*, Oct. 1973 p. 31.
- Swiss Watch and Jewelry Journal*, vol. 2, Mar. 1976 inside front cover.

Primary Examiner—Sandra L. Morris  
Attorney, Agent, or Firm—Crossetta & Associates

## [57] CLAIM

The ornamental design for a chess set, as shown.

## DESCRIPTION

FIG. 1 is a perspective view of a chess set, showing my new design, the broken line showing of the additional pieces and

the game board are for illustrative purposes only, and forms no part of the claimed design;

FIG. 2 is a top plan view of a king;

FIG. 3 is a front elevational view of the king of FIG. 2, the rear view being a mirror image thereof;

FIG. 4 is a right side elevational view of the king of FIG. 2, the opposite side being a mirror image thereof; and

FIG. 5 is a bottom plan view of the king of FIG. 2;

FIG. 6 is a top plan view of a queen;

FIG. 7 is a front elevational view of the queen of FIG. 6, the rear view being a mirror image thereof;

FIG. 8 is a right side elevational view of the queen of FIG. 6, the opposite side being a mirror image thereof; and

FIG. 9 is a bottom plan view of the queen of FIG. 6;

FIG. 10 is a top plan view of a bishop;

FIG. 11 is a front elevational view of the bishop of FIG. 10, the rear view being a mirror image thereof;

FIG. 12 is a right side elevational view of the bishop of FIG. 10, the opposite side being a mirror image thereof; and

FIG. 13 is a bottom plan view of the bishop of FIG. 10.

FIG. 14 is a top plan view of a knight;

FIG. 15 is a front elevational view of the knight of FIG. 14, the rear view being a mirror image thereof;

FIG. 16 is a right side elevational view of the knight of FIG. 14, the opposite side being a mirror image thereof; and

FIG. 17 is a bottom plan view of the knight of FIG. 14;

FIG. 18 is a top plan view of a rook;

FIG. 19 is a front elevational view of the rook of FIG. 18, the rear view being a mirror image thereof;

FIG. 20 is a right side elevational view of the rook of FIG. 18, the opposite side being a mirror image thereof; and

FIG. 21 is a bottom plan view of the rook of FIG. 18;

FIG. 22 is a top plan view of a pawn;

FIG. 23 is a front elevational view of the pawn of FIG. 22, the rear view being a mirror image thereof;

FIG. 24 is a right side elevational view of the pawn of FIG. 22, the opposite side being a mirror image thereof; and

FIG. 25 is a bottom plan view of the pawn of FIG. 22.

1 Claim, 4 Drawing Sheets

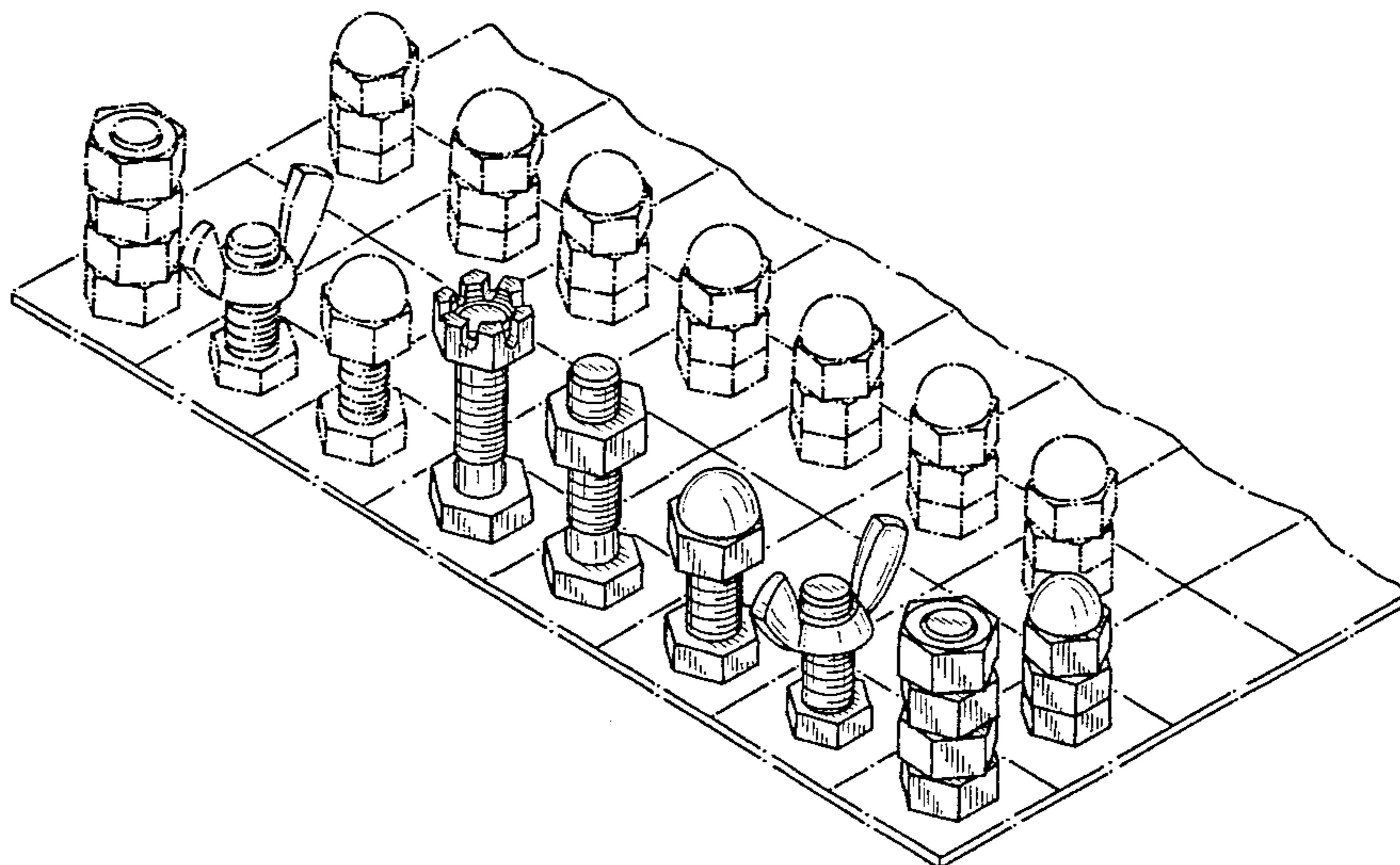



Fig. 2.

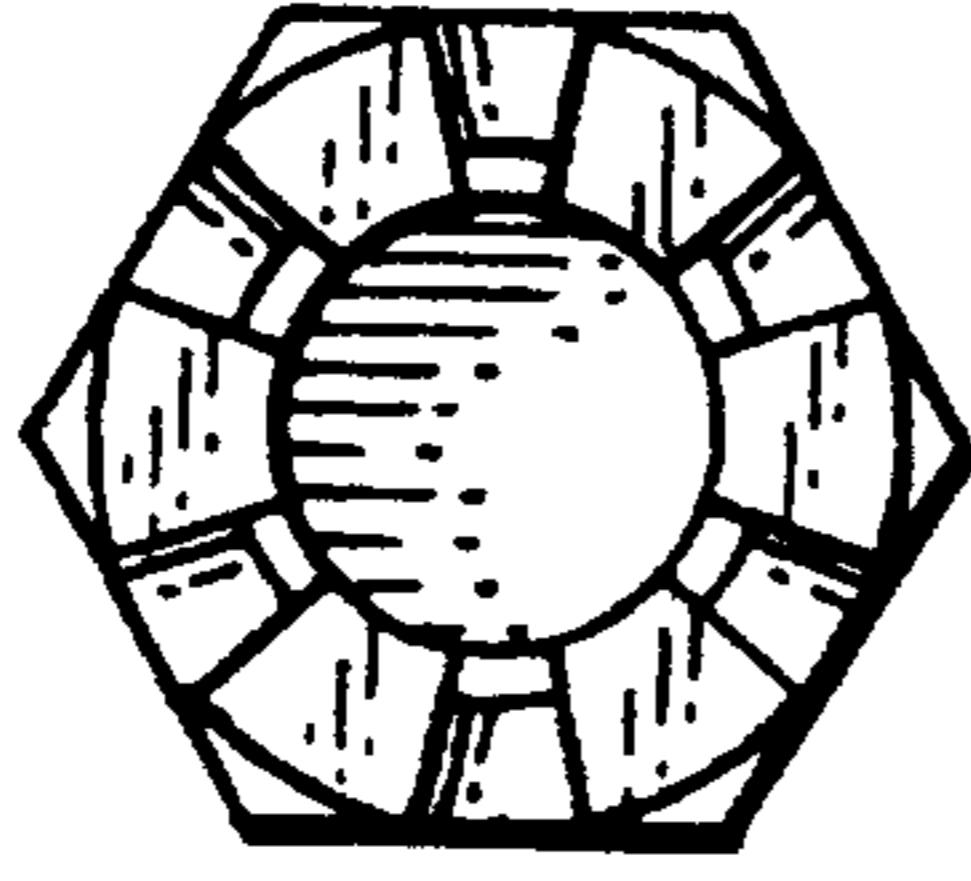

Fig. 6.

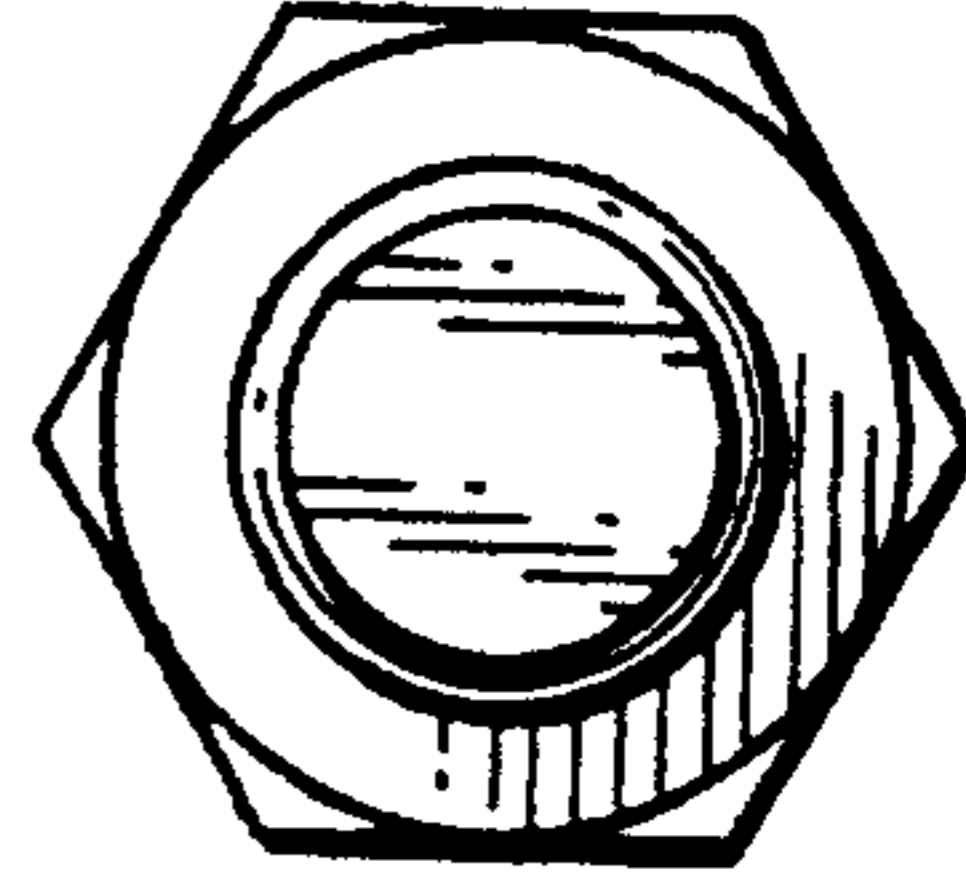

Fig. 3.

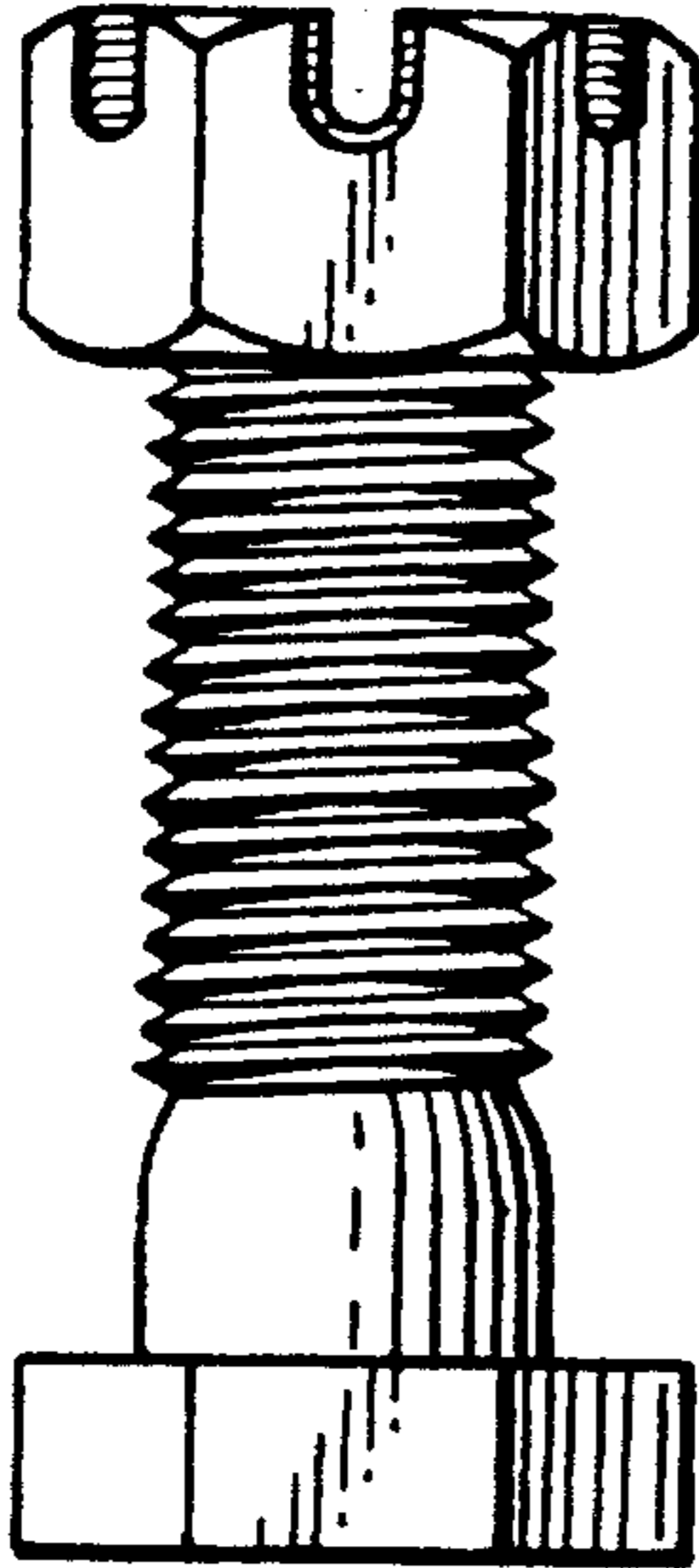

Fig. 7.

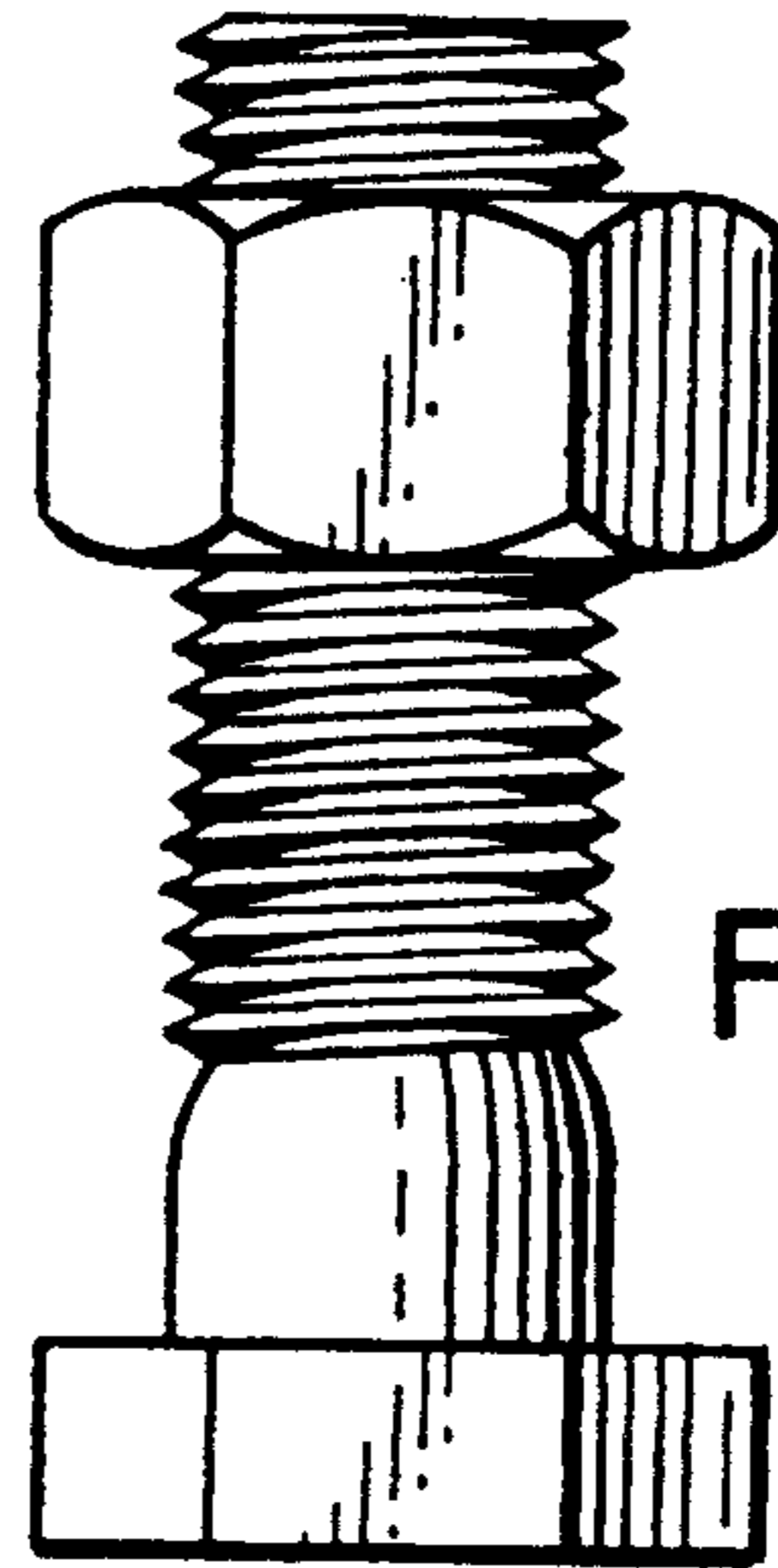

Fig. 4.

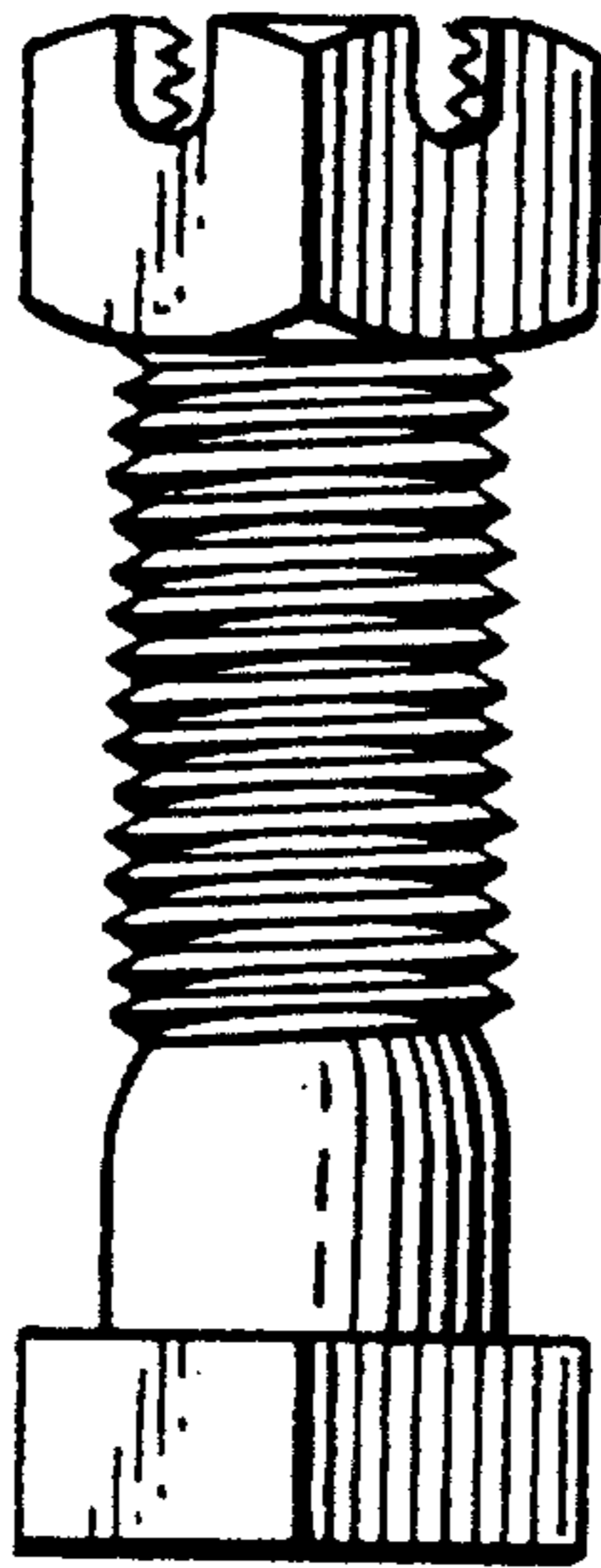

Fig. 8.

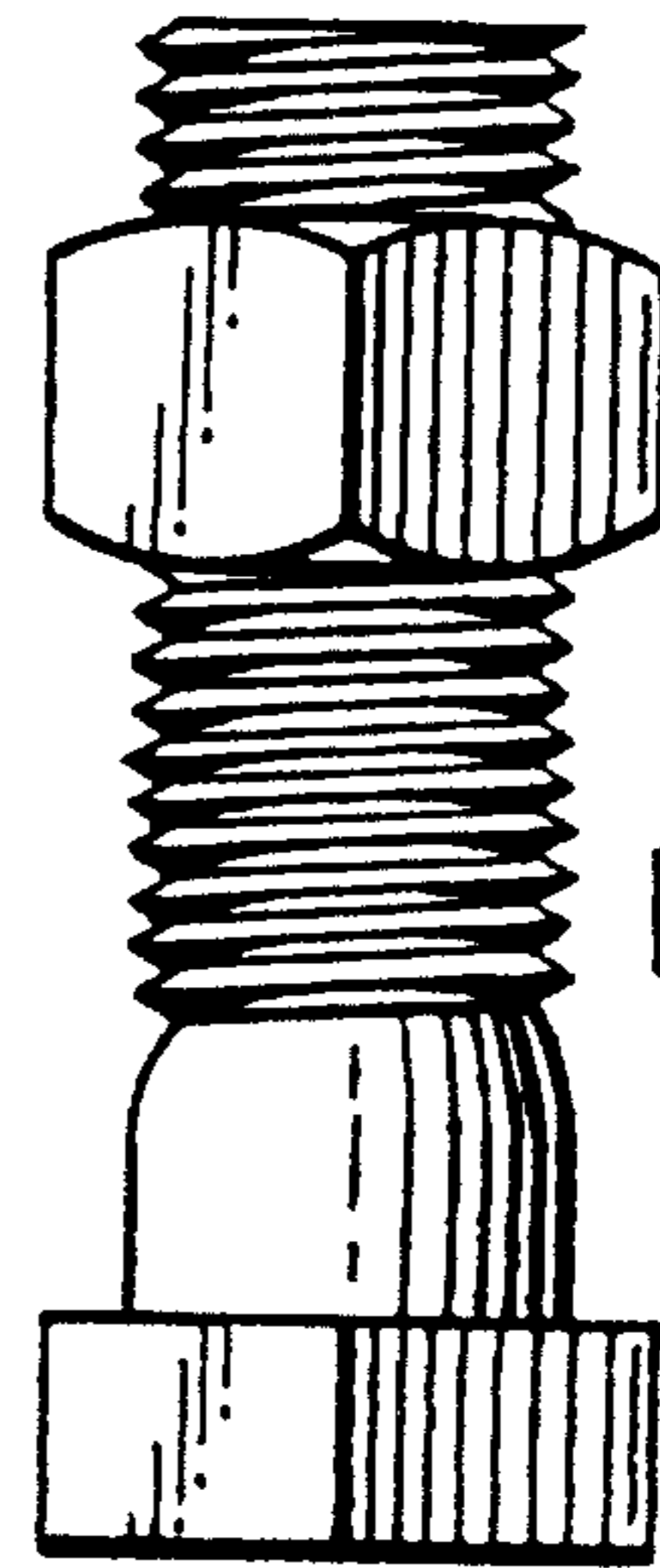

Fig. 5.

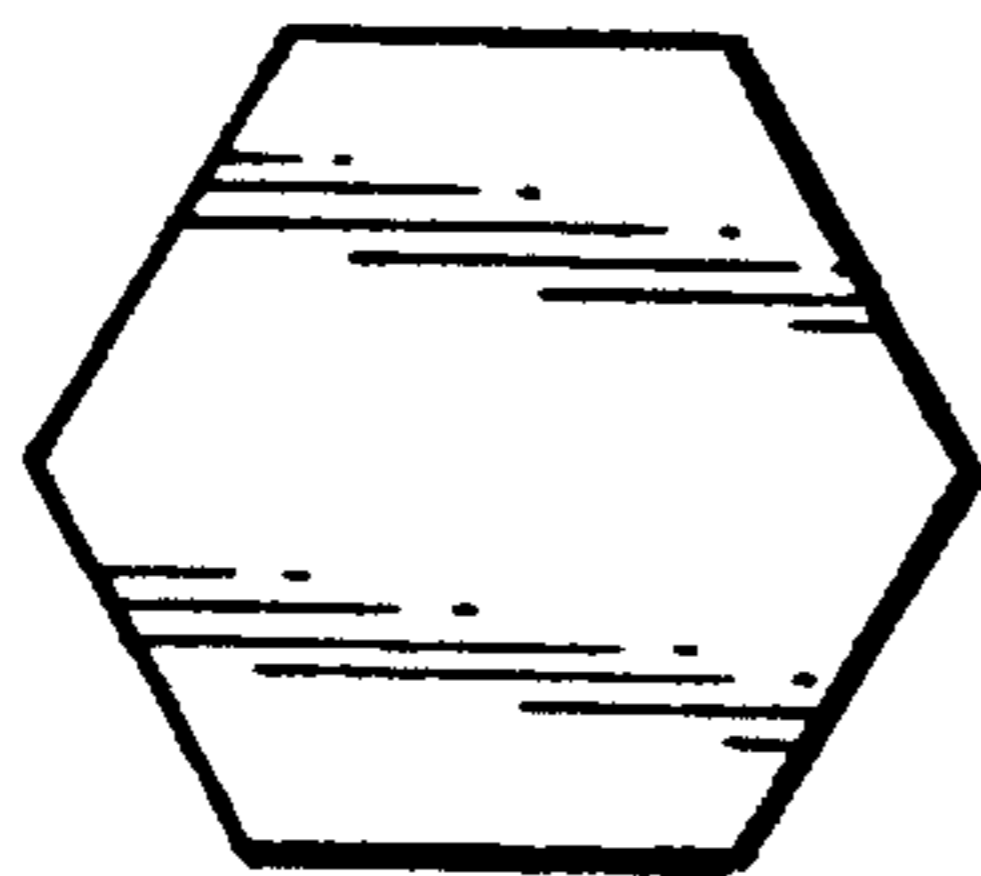

Fig. 9.

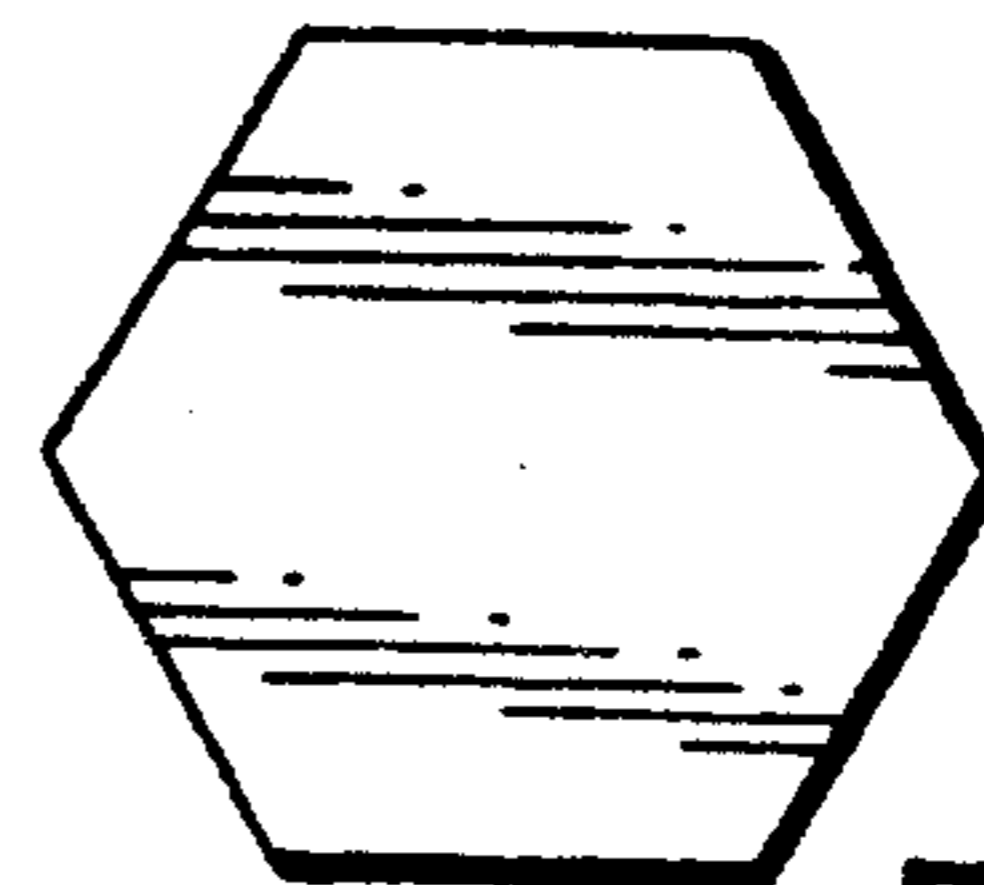

Fig. 10.

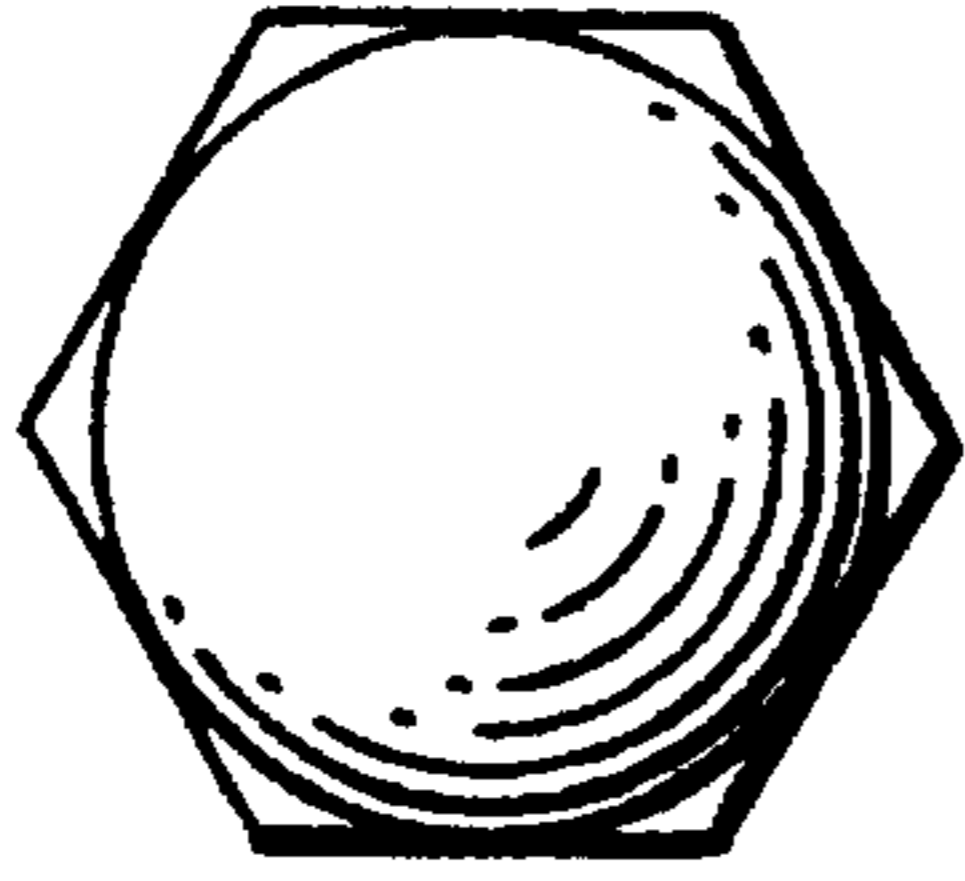

Fig. 14.

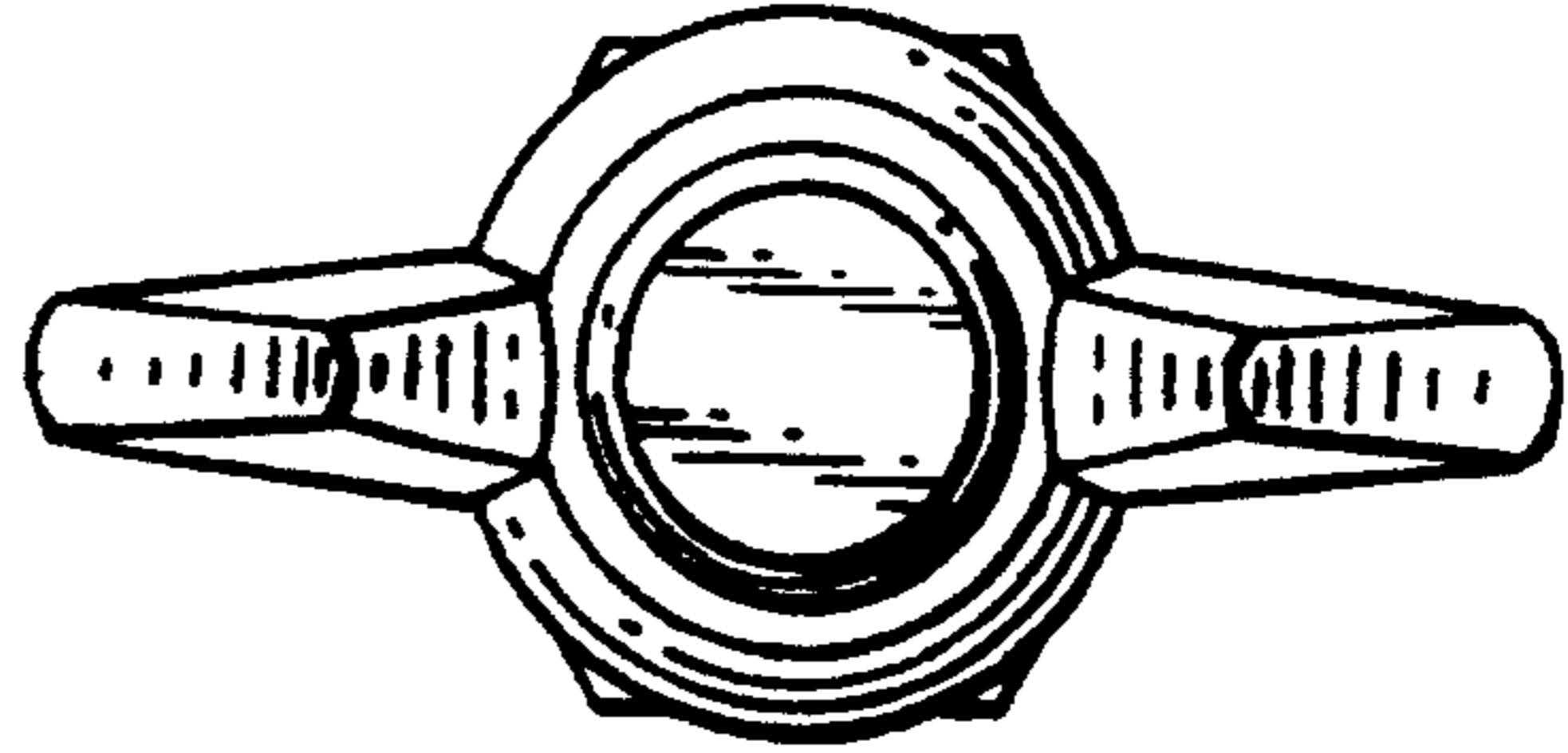

Fig. 11.

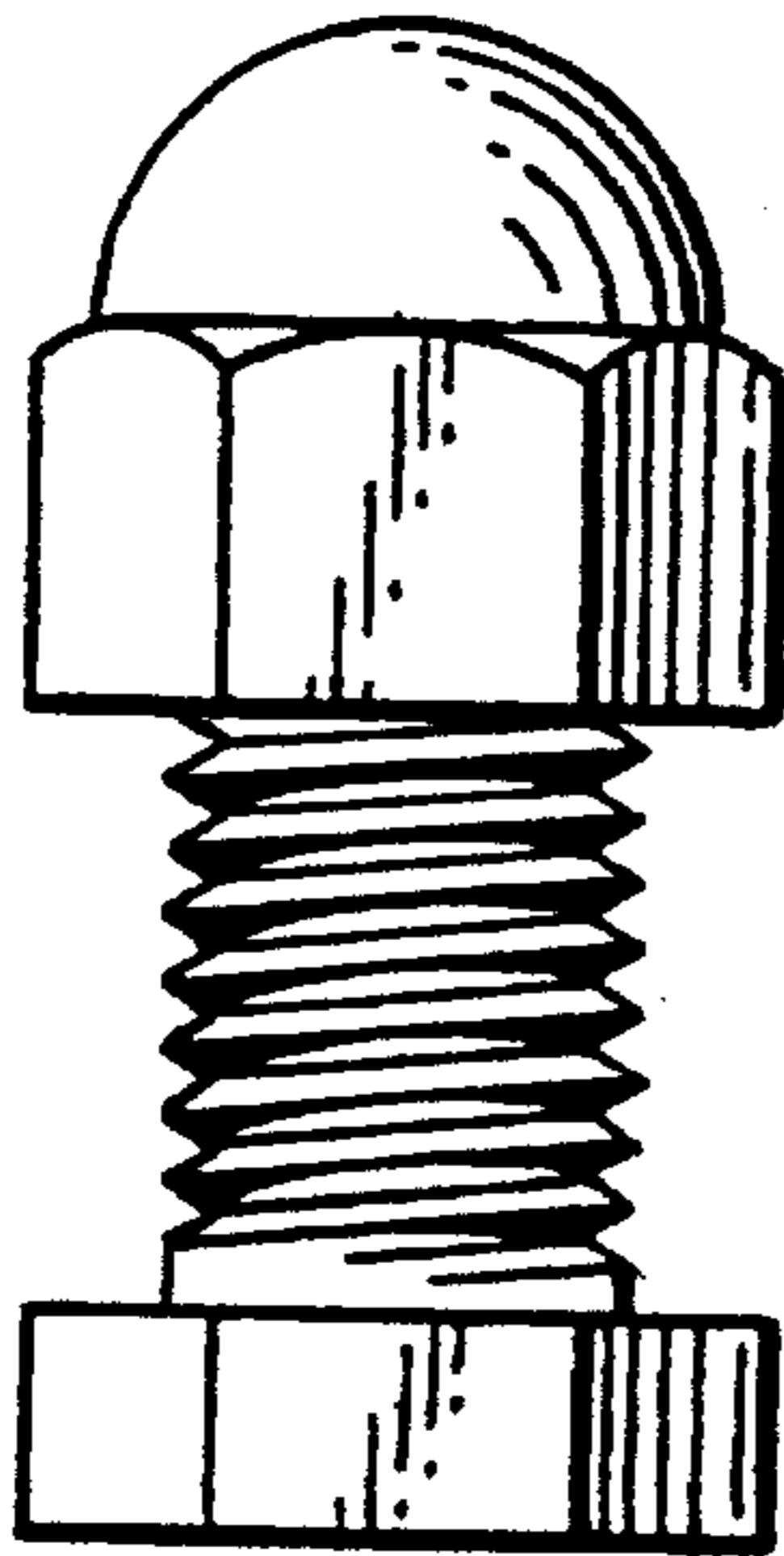

Fig. 15.

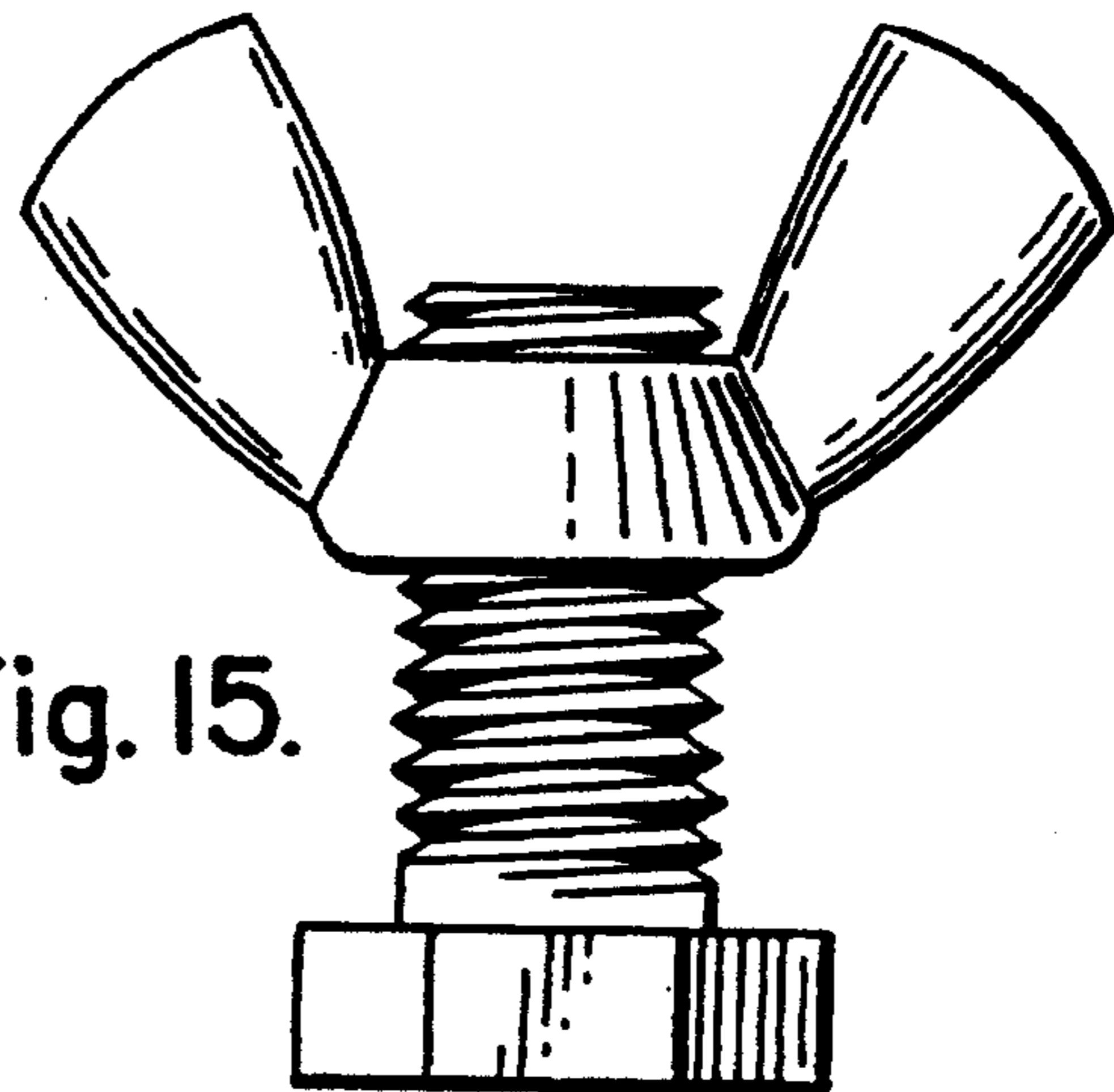

Fig. 12.

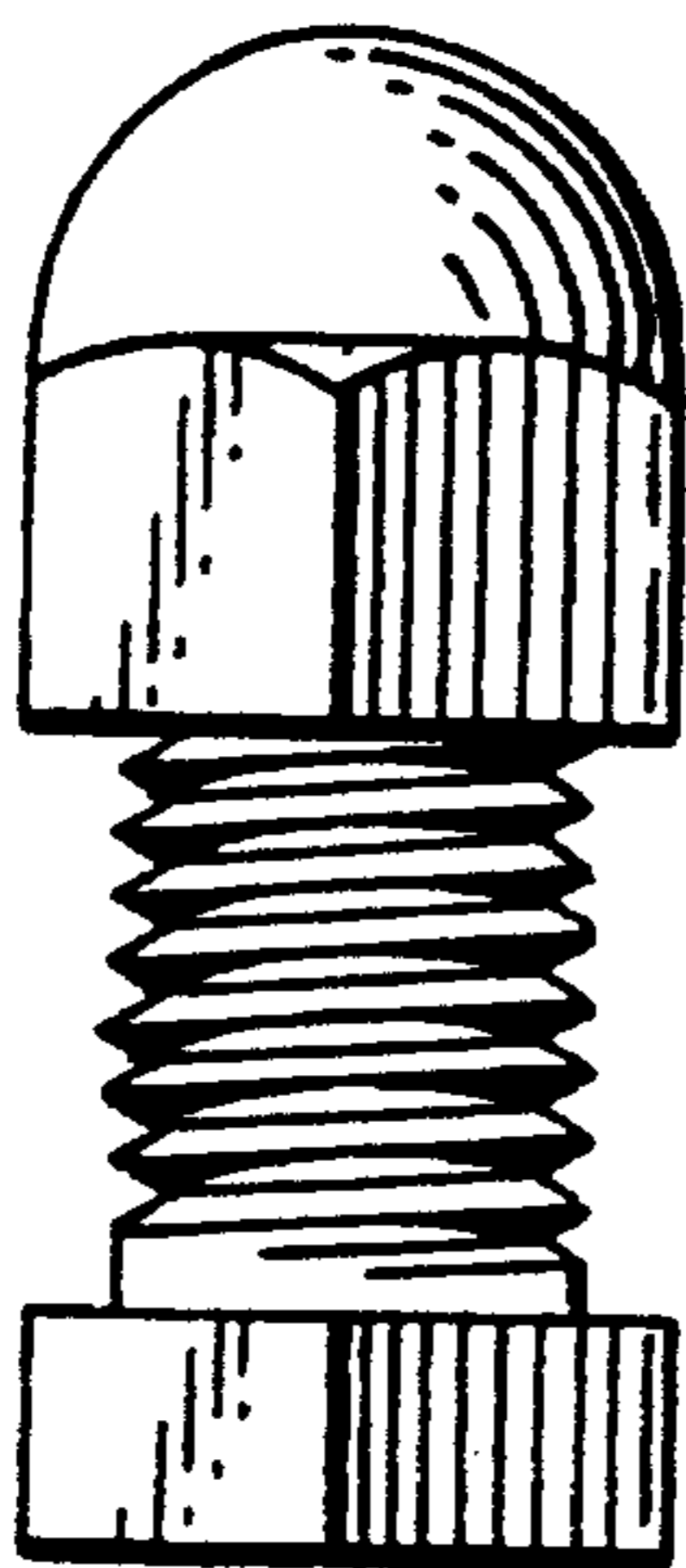

Fig. 16.

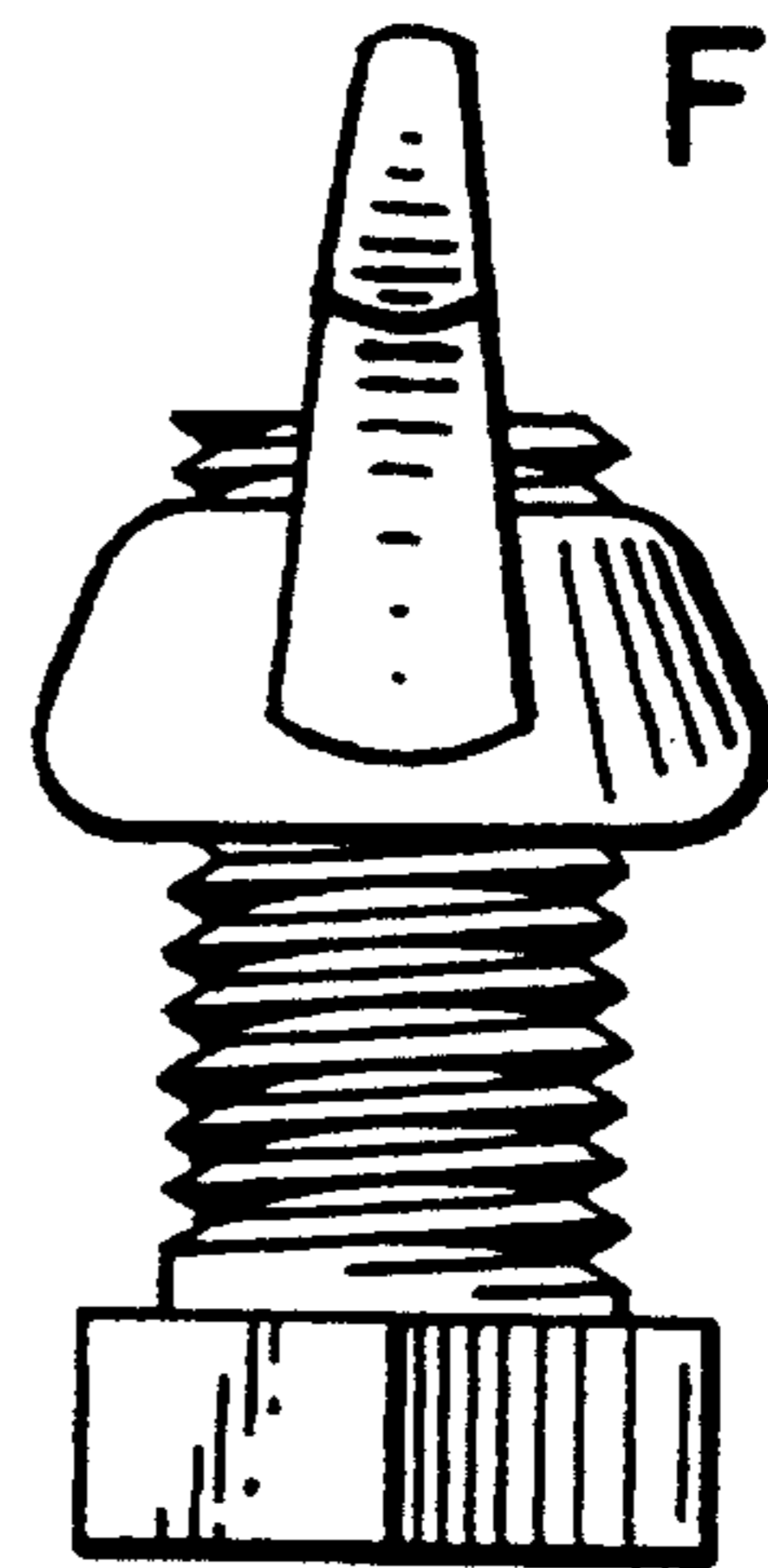

Fig. 13.

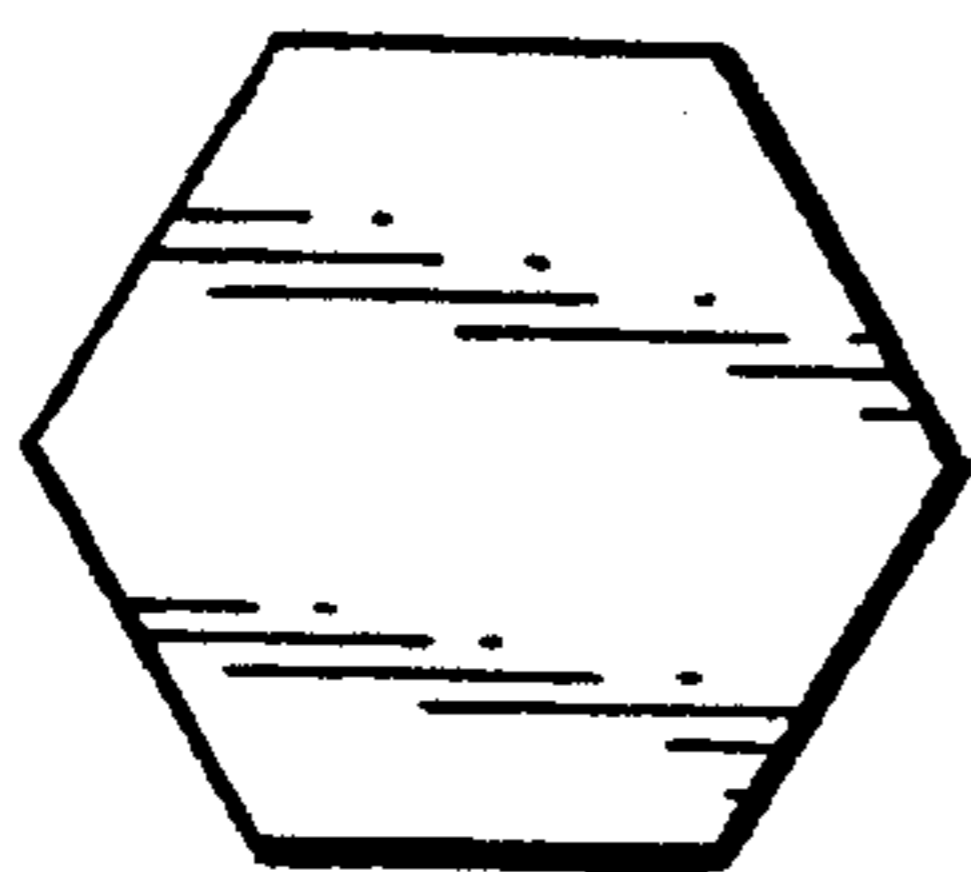

Fig. 17.

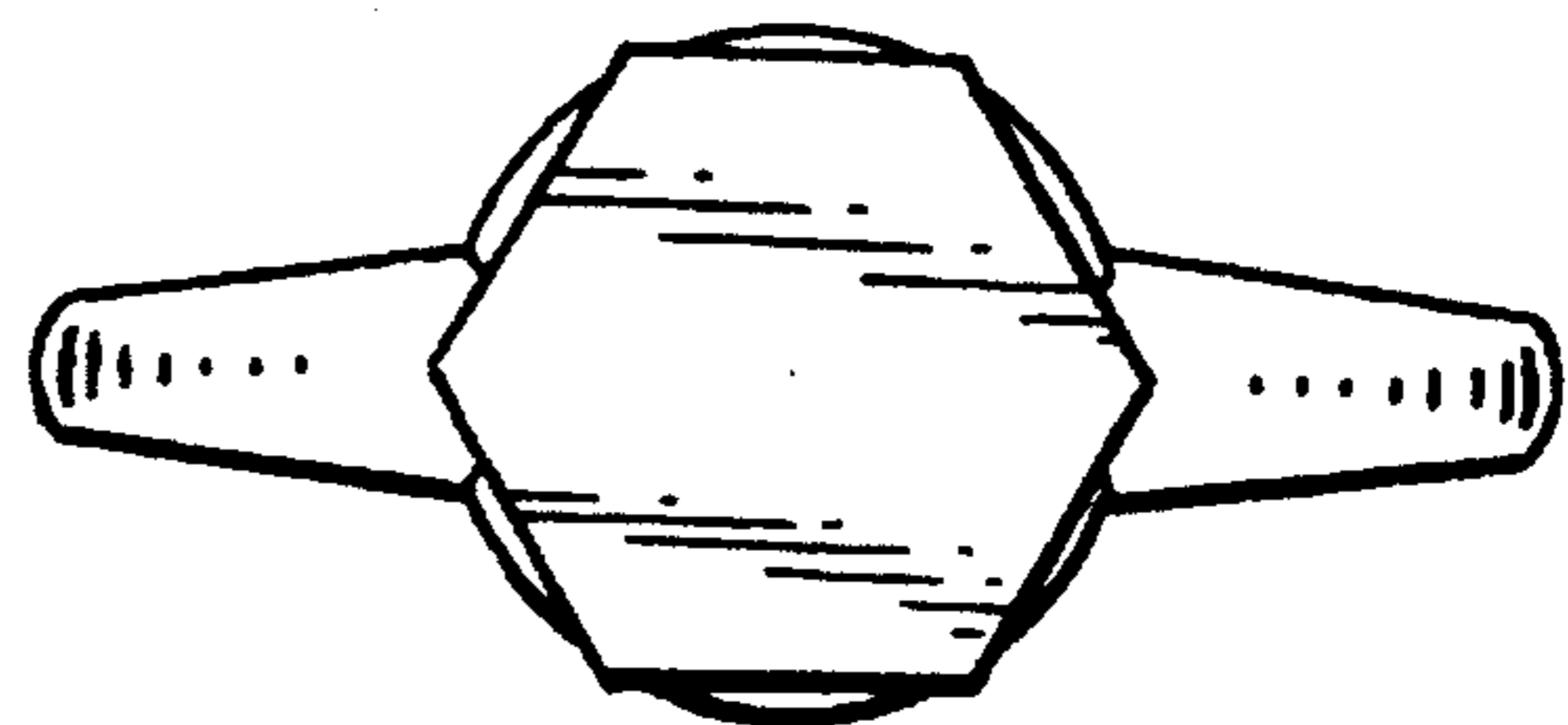

Fig.18.

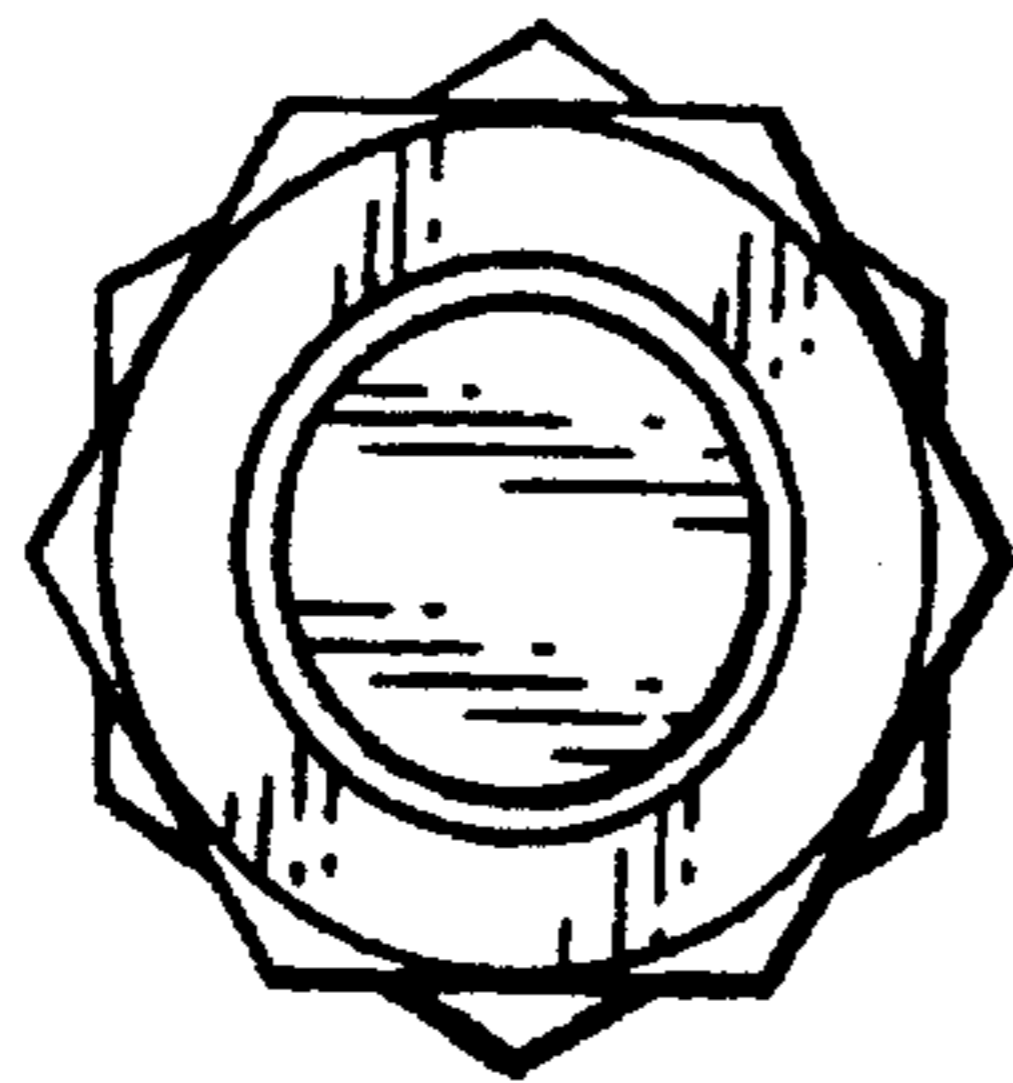

Fig.22.

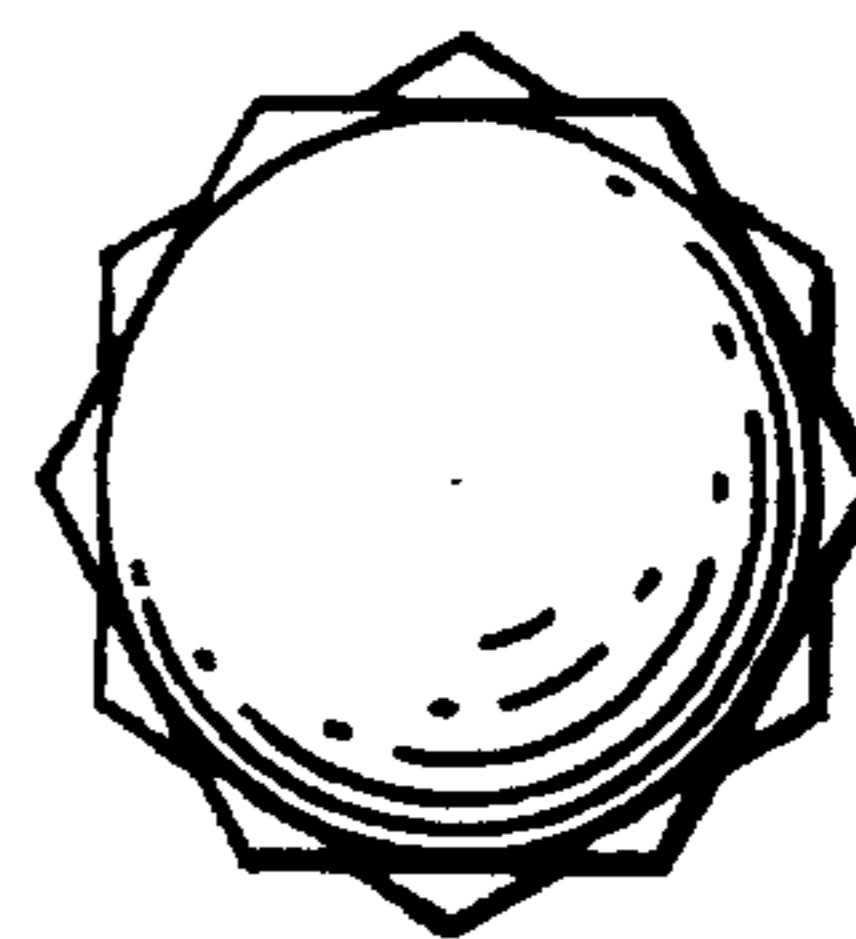

Fig.19.

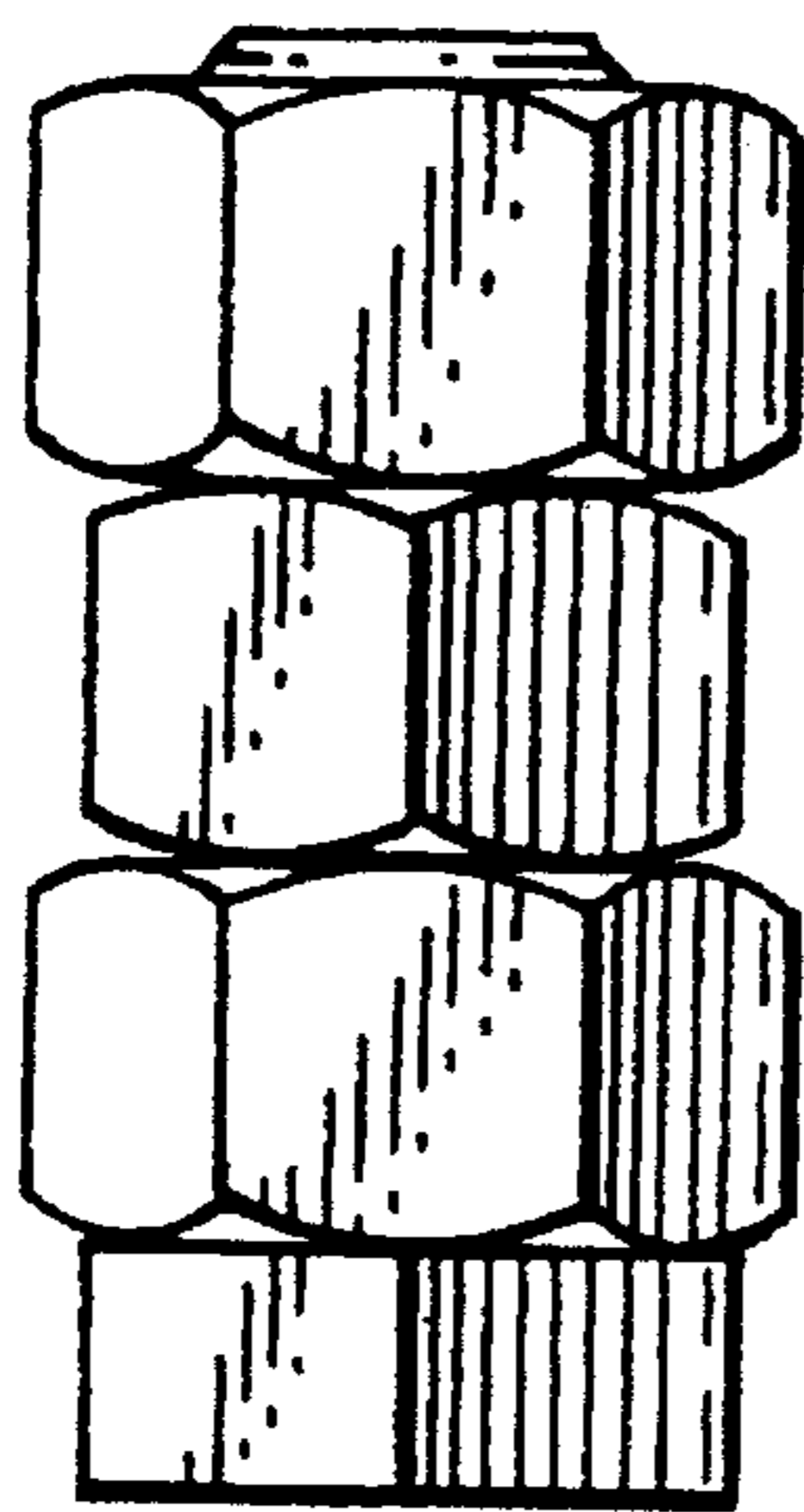

Fig.23.

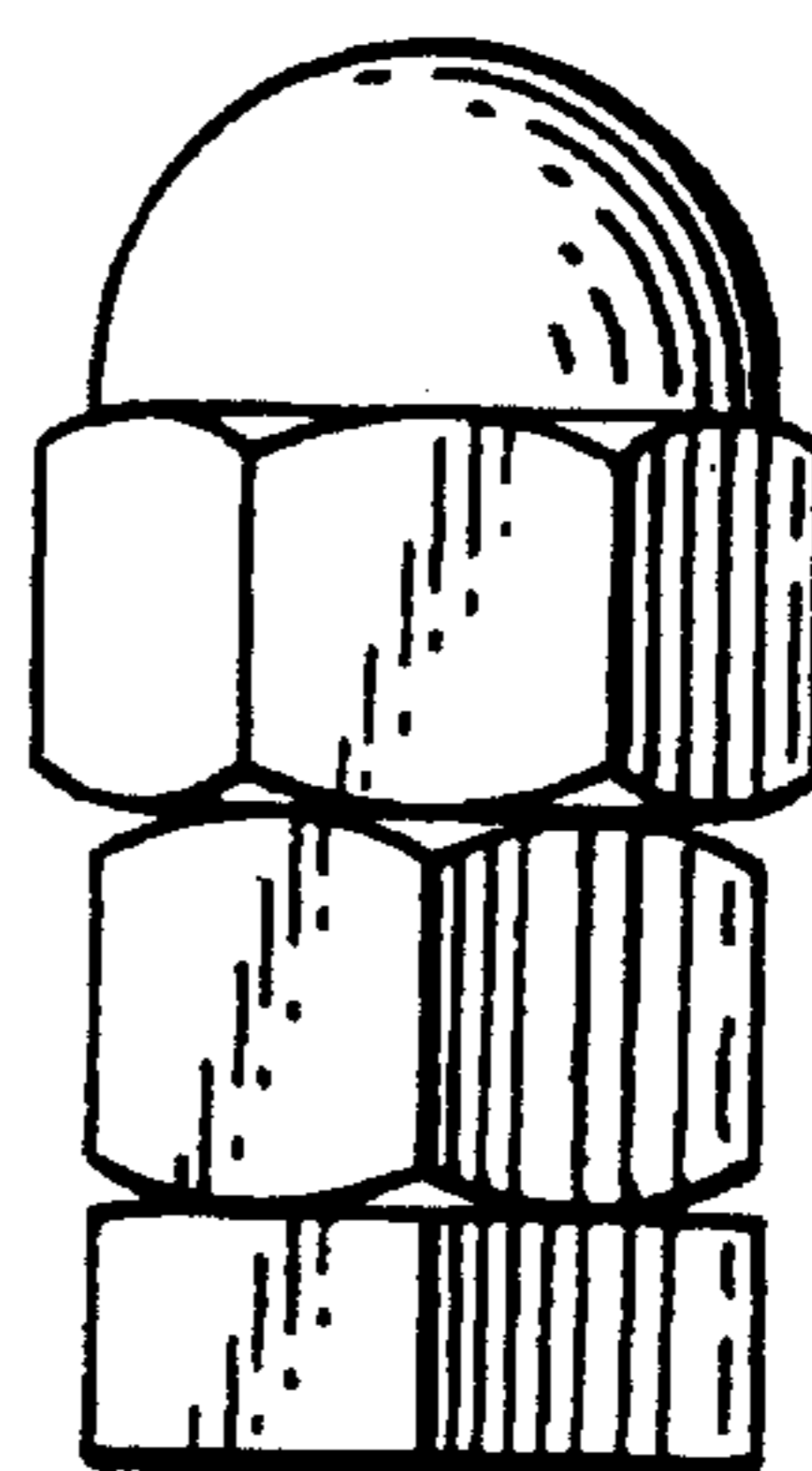

Fig.20.

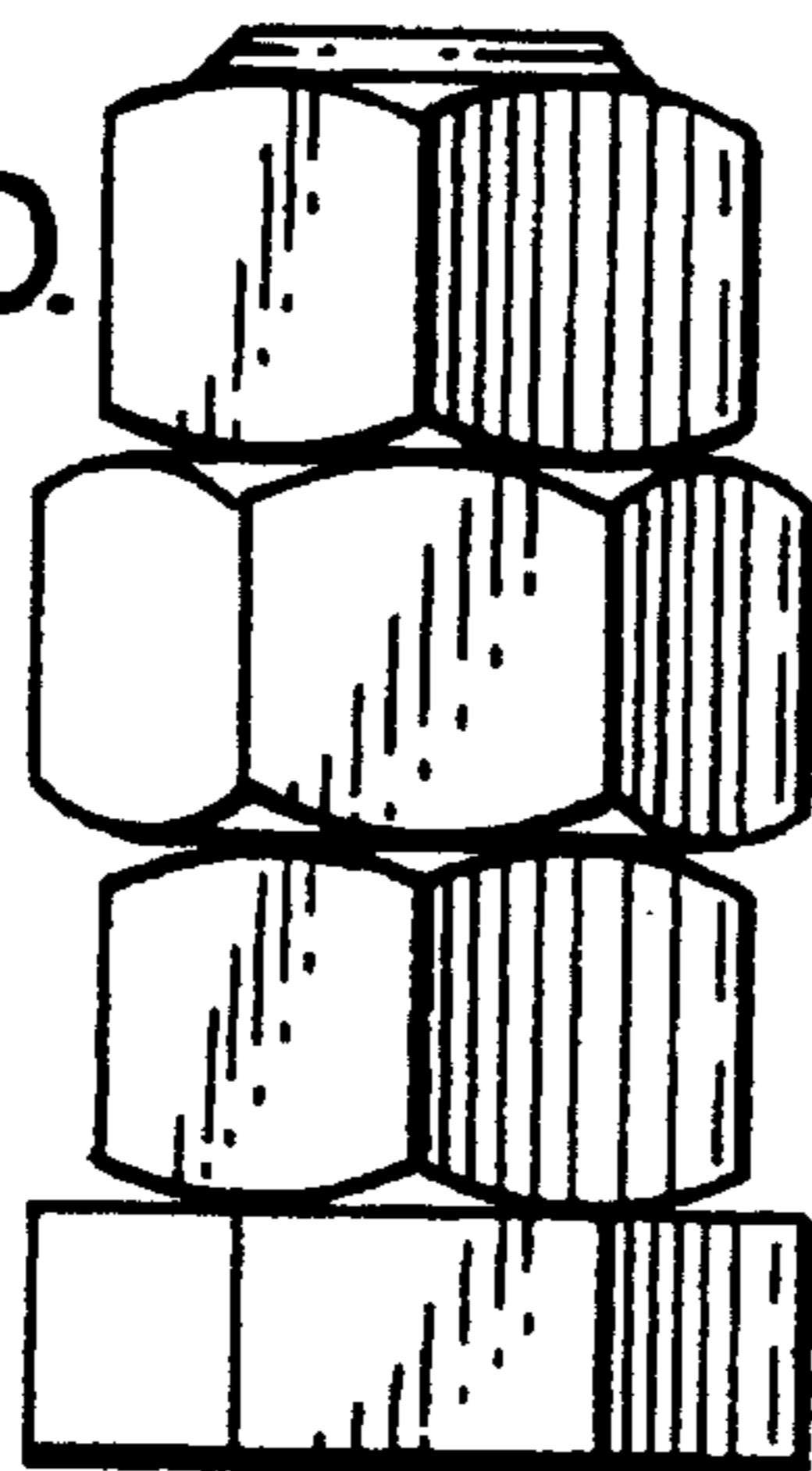

Fig.24.

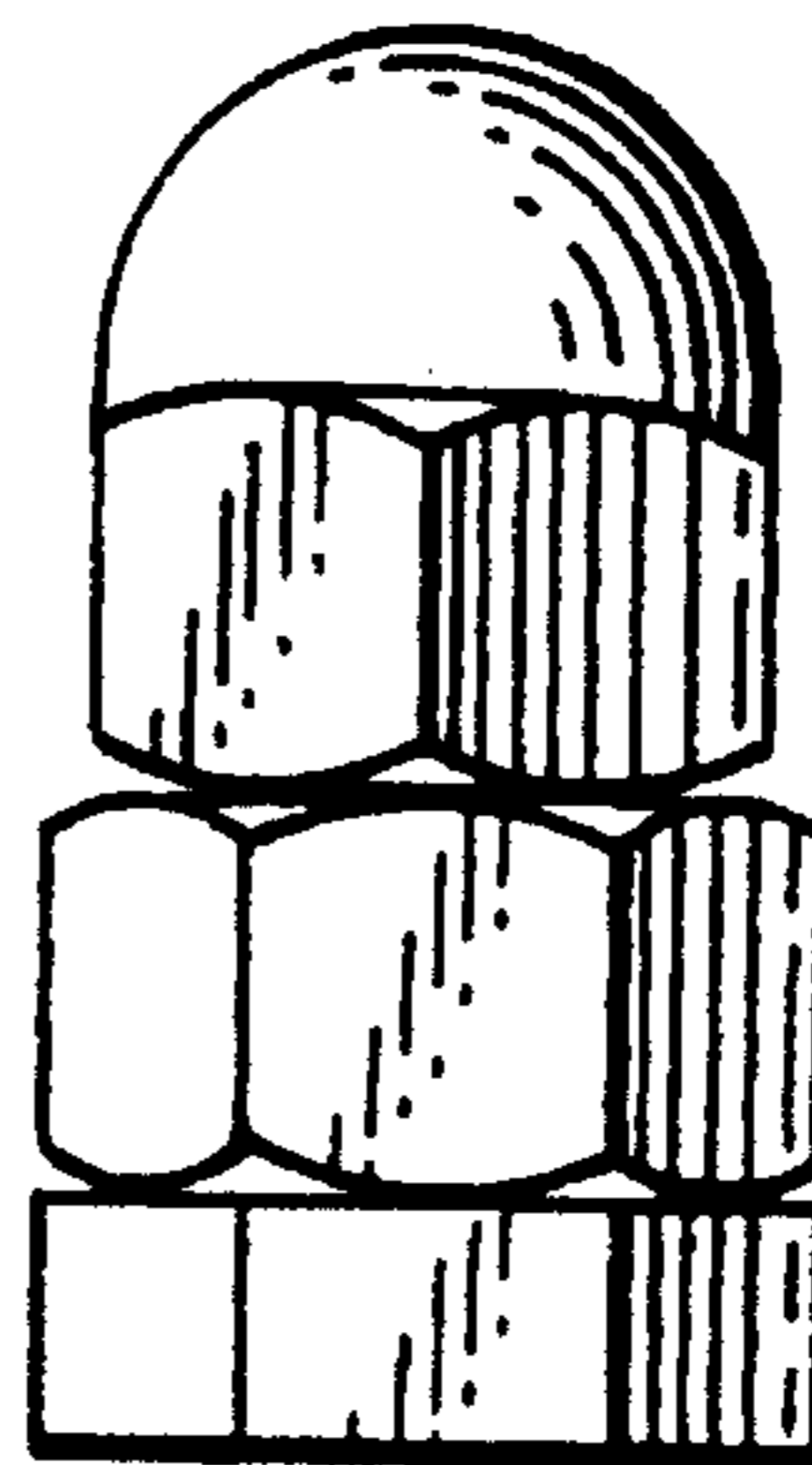

Fig.21.

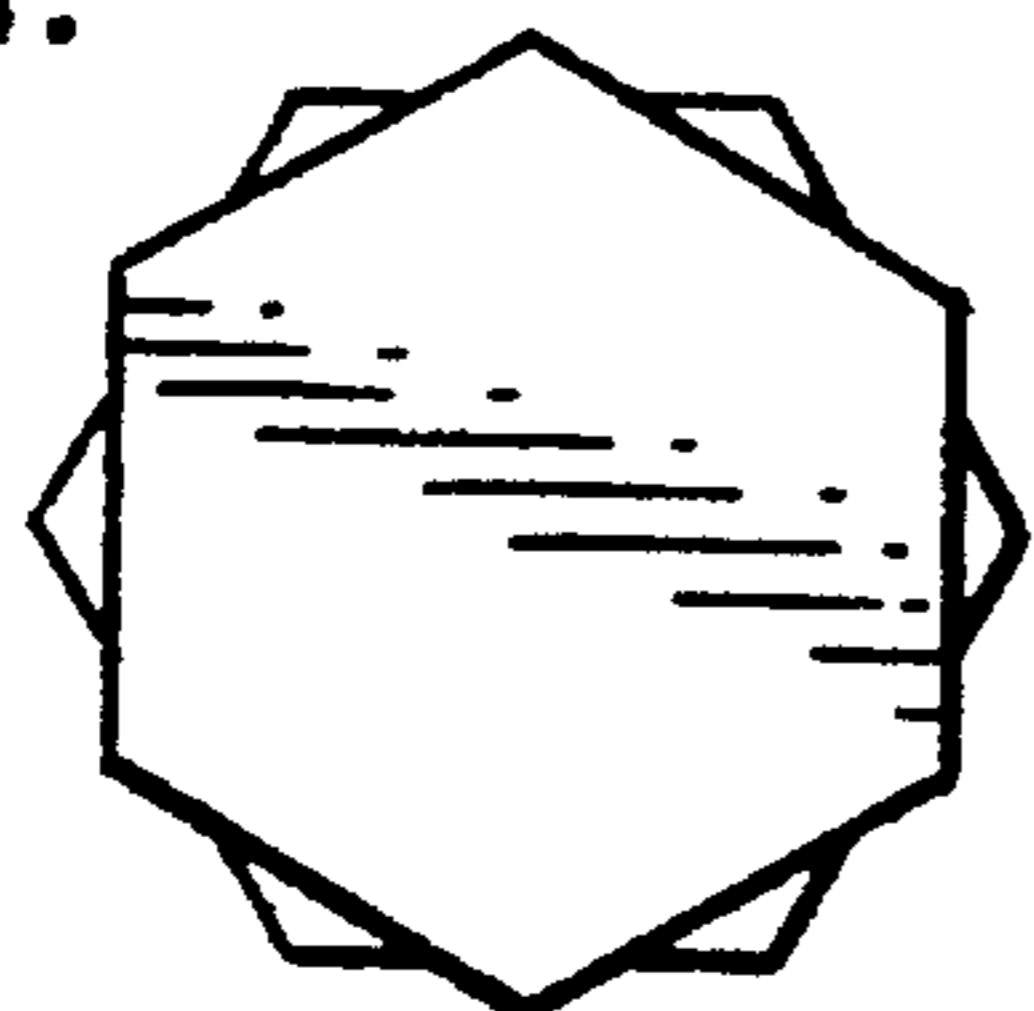

Fig.25.

