



US00D373596S

United States Patent [19]

Sekine et al.

[11] Patent Number: **Des. 373,596**

[45] Date of Patent: ****Sep. 10, 1996**

[54] **PRINTER FOR ELECTRONIC COMPUTER**

[75] Inventors: **Tetsuya Sekine, Kawasaki; Hiroyuki Tokuda, Yokohama, both of Japan**

[73] Assignee: **Canon Kabushiki Kaisha, Tokyo, Japan**

[**] Term: **14 Years**

[21] Appl. No.: **20,499**

[22] Filed: **Mar. 28, 1994**

[30] Foreign Application Priority Data

Sep. 29, 1993 [JP] Japan 5-29393

[52] U.S. Cl. **D18/55**

[58] Field of Search D18/50, 54-55; 400/88, 691-694, 613, 613.1-613.4, 690.1-690.4; 347/222, 245, 264, 170, 108

[56] References Cited

U.S. PATENT DOCUMENTS

D. 285,211	8/1986	Nibley et al.	D18/55
D. 293,113	12/1987	Foy	D18/54
D. 315,360	3/1991	Tokuda et al.	D18/54
D. 321,002	10/1991	Tashiro et al.	D18/54
D. 321,711	11/1991	Yoshihara et al.	D18/54
D. 322,981	1/1992	Tokuda	D18/54
D. 322,982	1/1992	Tashiro	D18/54
D. 323,344	1/1992	Umino et al.	D18/54
D. 335,894	5/1993	Nishikaze et al.	D18/55
D. 337,608	7/1993	Miyamoto	D18/55
D. 339,156	9/1993	Sato et al.	D18/50
D. 339,157	9/1993	Miyamoto et al.	D18/50
D. 339,158	9/1993	Sato	D18/50

D. 339,372	9/1993	Kando	D18/50
D. 343,191	1/1994	Kobayashi	D18/55
D. 343,637	1/1994	Umino et al.	D18/55
3,375,781	4/1968	Grimm et al. .	

FOREIGN PATENT DOCUMENTS

65798	4/1990	Canada	D18/55
-------	--------	--------------	--------

OTHER PUBLICATIONS

Amdex 5040 daisy Wheel Printer Advertisement in Byte Magazine; Apr. 1984; p. 43.

Burroughs OFIS™fax brochure; Mar. 1982; dex 3600.

Dell Catalog; Jun. 1992; p. 7, Panasonic KX-P2123 dot matrix printer.

TekColor brochure; Feb. 1993; Tektronix Phaser™ 200 Color Printer.

Primary Examiner—Cathy Anne MacCormac

Attorney, Agent, or Firm—Fitzpatrick, Cella, Harper & Scinto

[57] CLAIM

The ornamental design for a printer for electronic computer, as shown and described.

DESCRIPTION

FIG. 1 is a front elevational view of a printer for electronic computer, showing our new design;

FIG. 2 is a rear elevational view thereof;

FIG. 3 is a top plan view thereof;

FIG. 4 is a bottom plan view thereof;

FIG. 5 is a left side elevational view thereof;

FIG. 6 is a right side elevational view thereof; and,

FIG. 7 is a perspective view thereof.

1 Claim, 3 Drawing Sheets

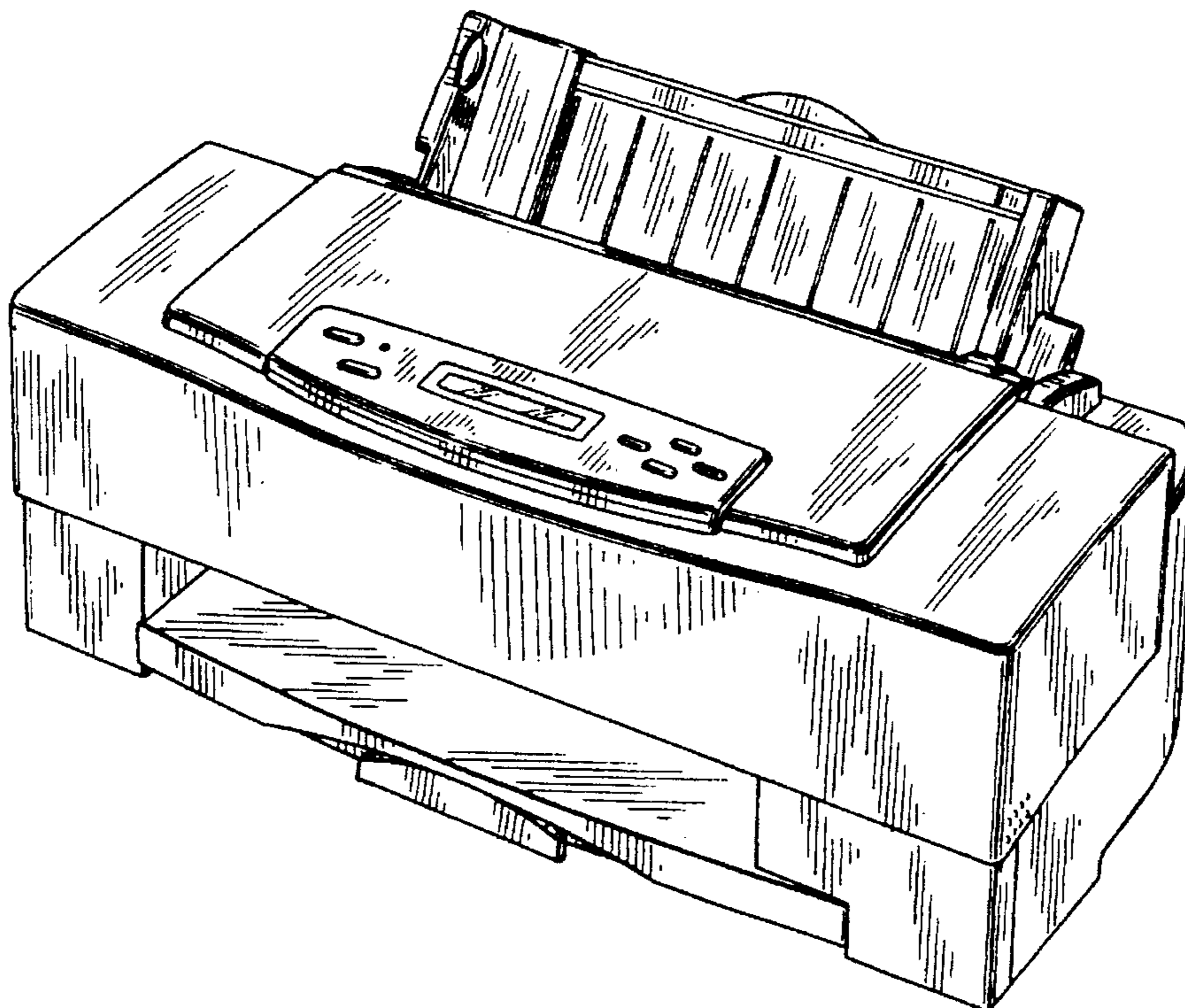

FIG. 1

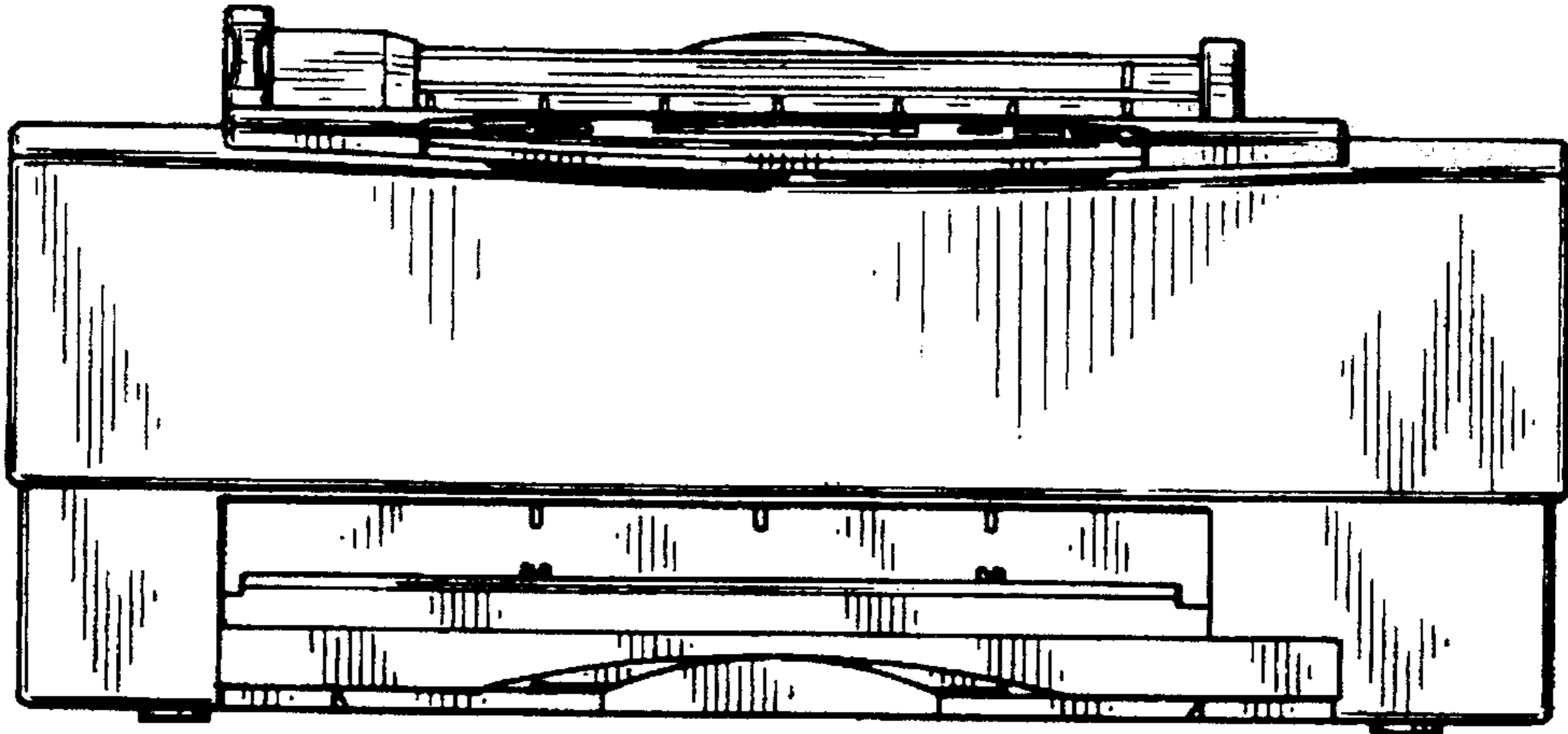

FIG. 2

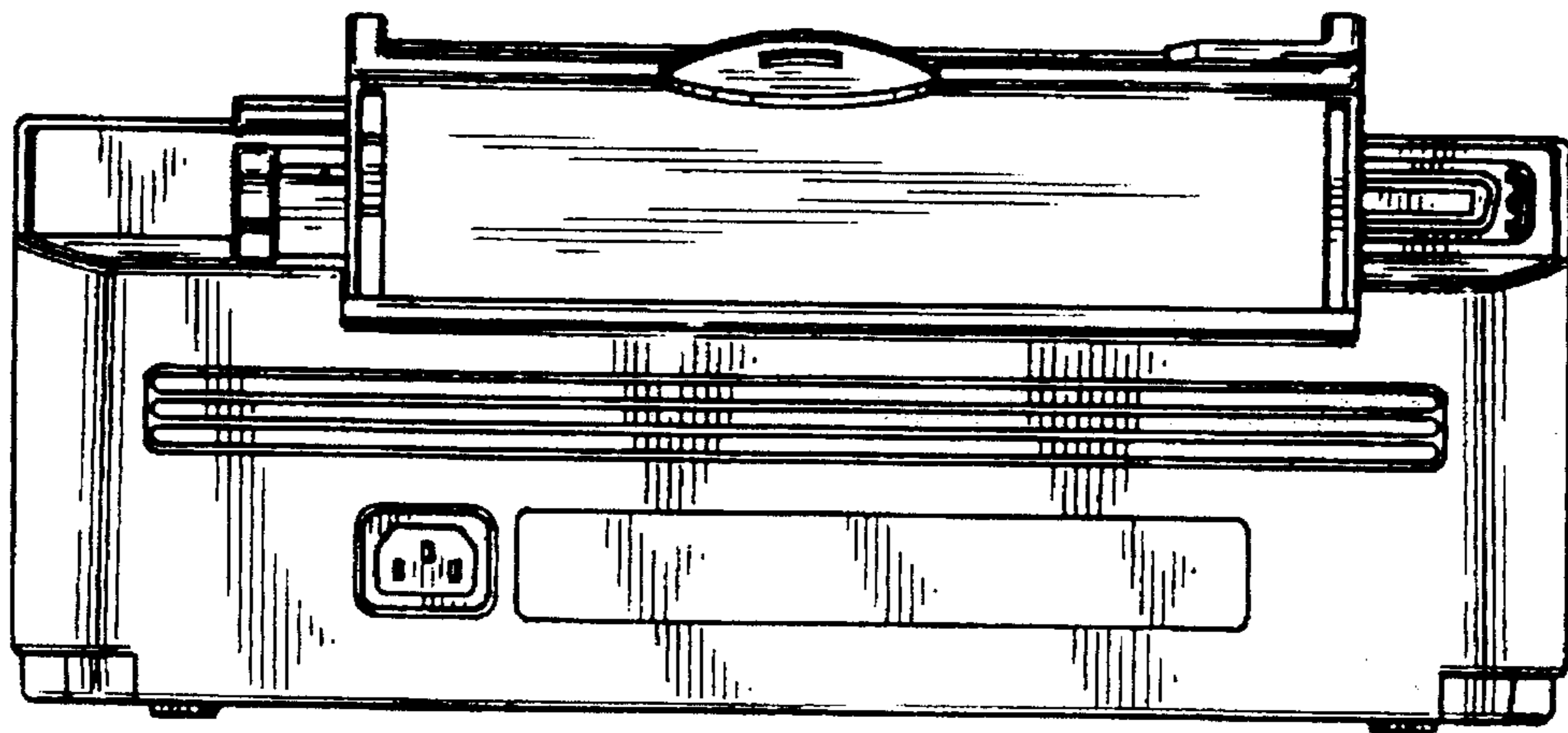

FIG. 3

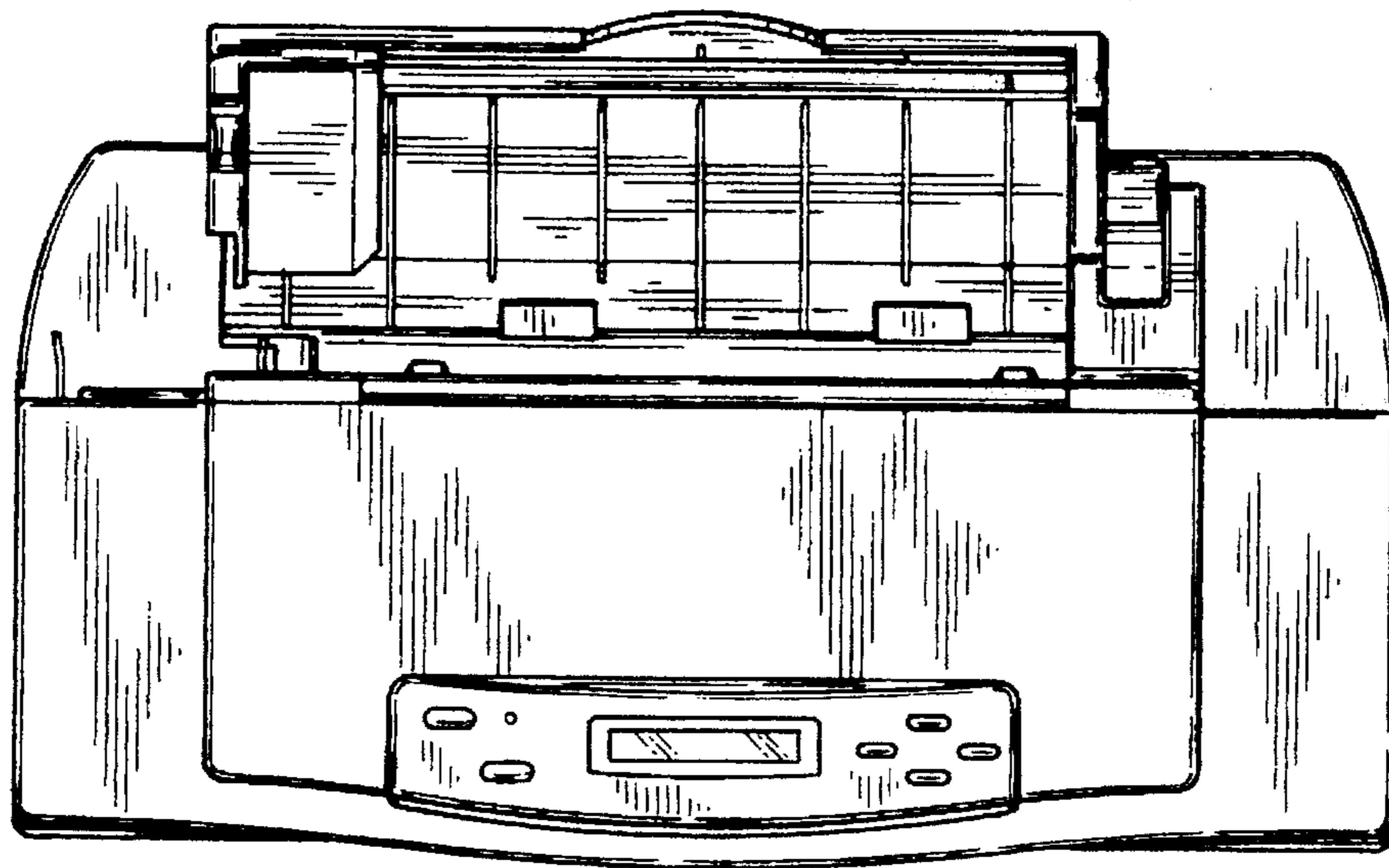

FIG. 4

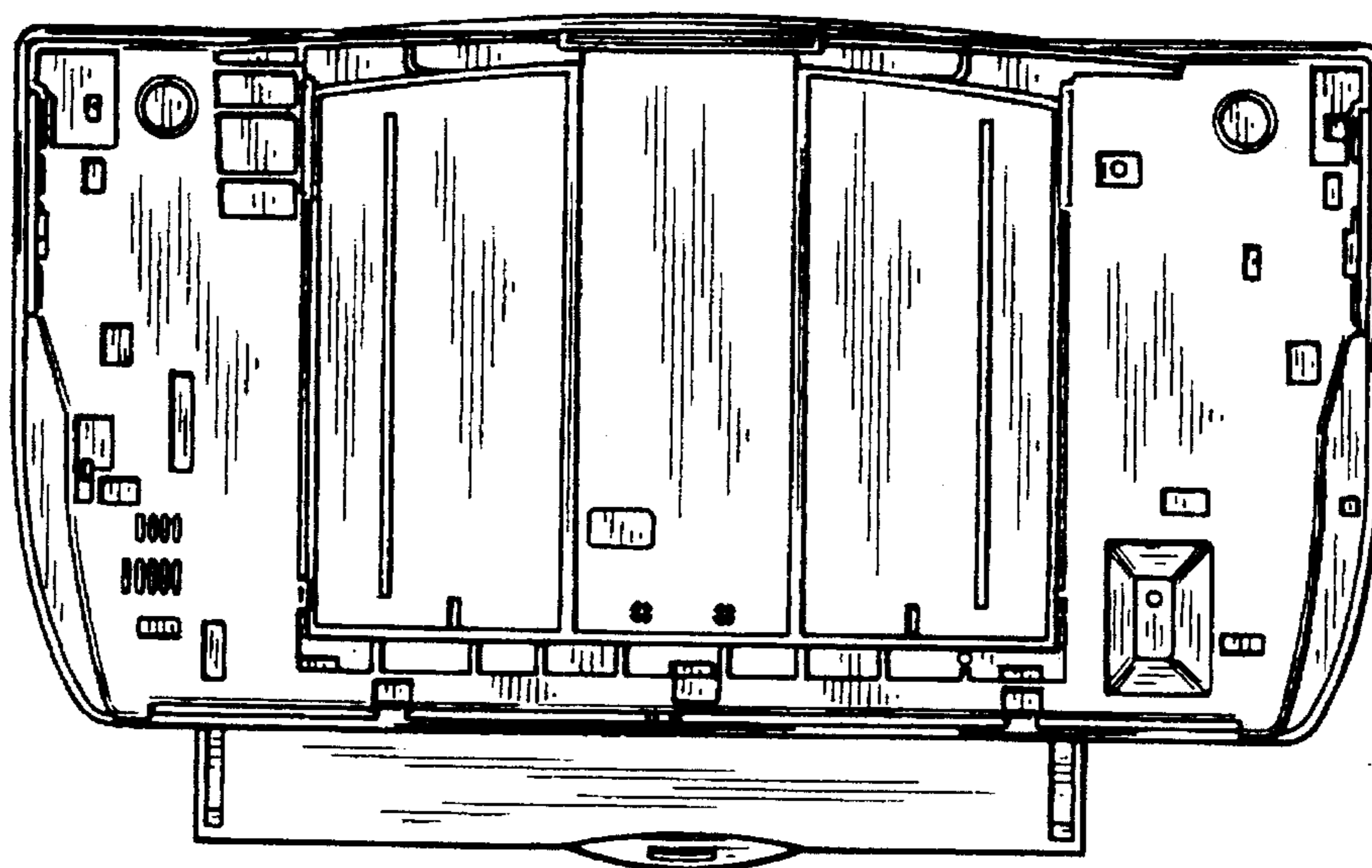

FIG. 5

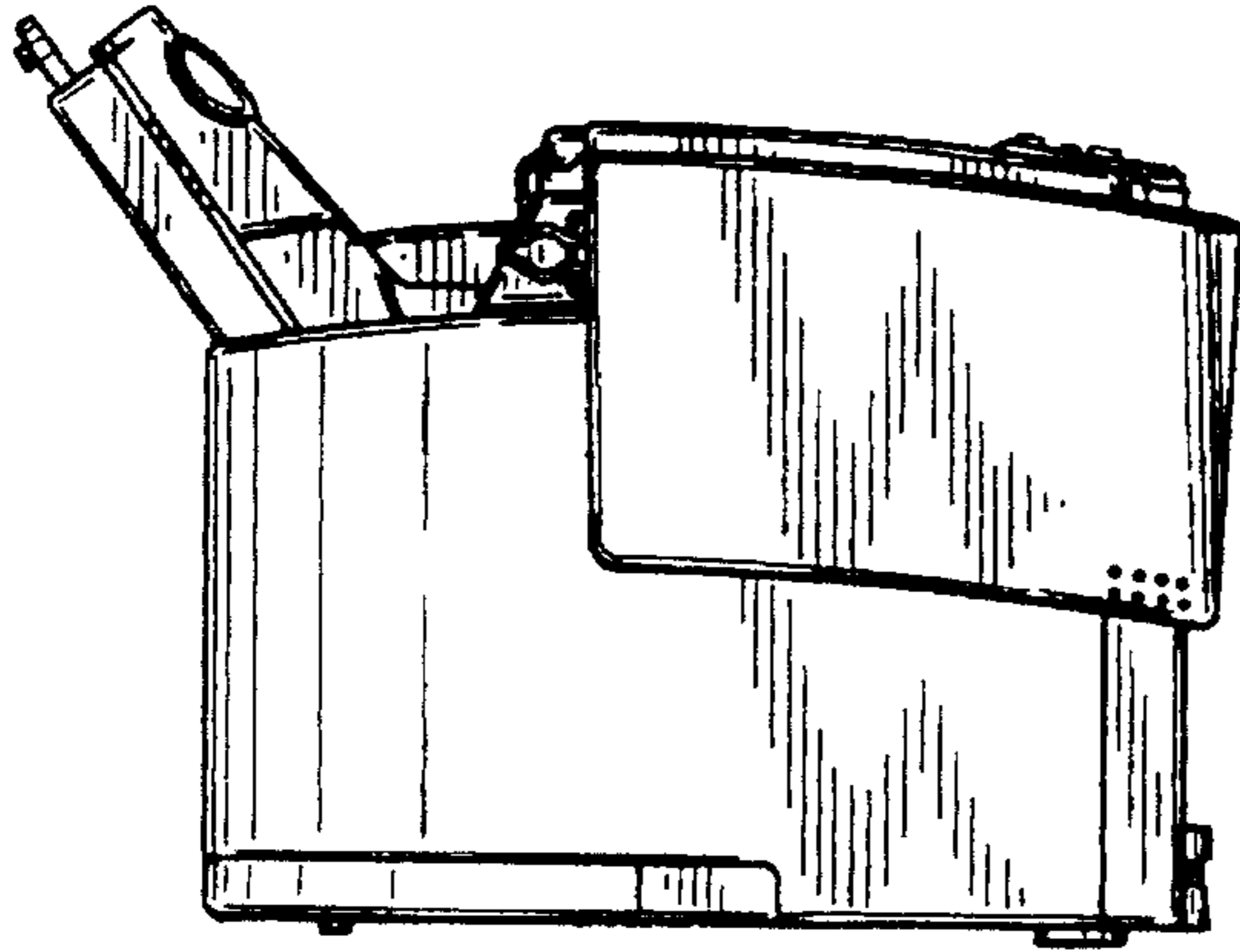

FIG. 6

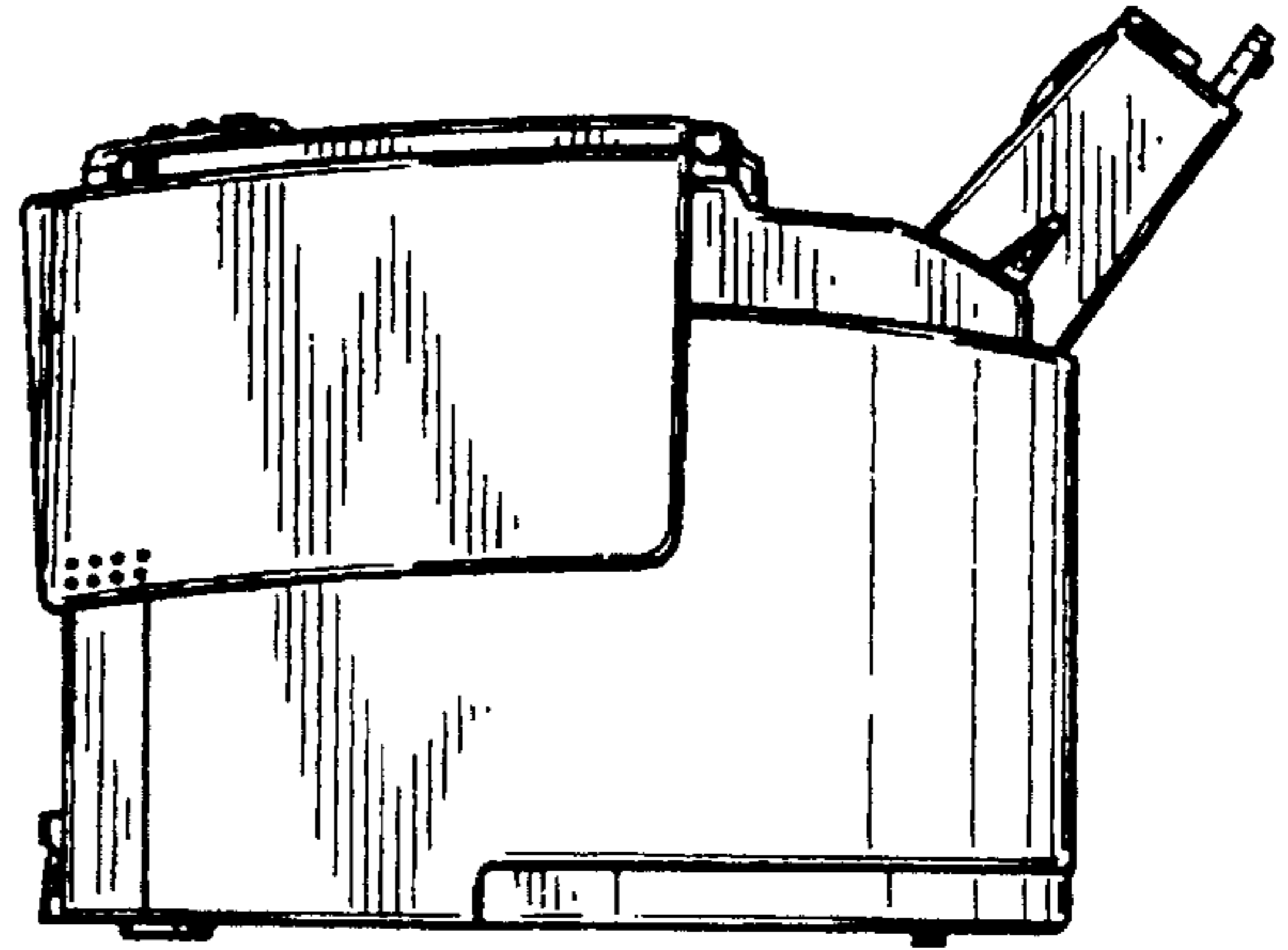

FIG. 7

