



US00D373442S

United States Patent [19]

Thomas

[11] Patent Number: **Des. 373,442**

[45] Date of Patent: ****Sep. 3, 1996**

[54] **BIKER LIGHTER**

[76] Inventor: **Mark L. Thomas**, 4622 N. Hermitage, Chicago, Ill. 60640

[**] Term: **14 Years**

[21] Appl. No.: **40,949**

[22] Filed: **Jun. 30, 1995**

[52] U.S. Cl. **D27/141**

[58] Field of Search D27/141, 142, D27/143, 153, 154, 155, 156, 157, 158, 159, 160, 161; 431/253, 310, 343

[56] **References Cited**

U.S. PATENT DOCUMENTS

2,737,036	10/1954	Simpson	431/310
3,735,099	5/1973	Herr	431/253 X
4,082,496	4/1978	Johnson	431/343
4,176,773	12/1979	Wilkinson	224/205
4,486,169	12/1984	Lewis	431/253
4,745,661	5/1988	Wainscott	24/3M
4,898,532	2/1990	Bercik	431/253
4,927,354	5/1990	Sanford	431/253
5,271,730	12/1993	da Silva	431/253

OTHER PUBLICATIONS

Gift catalog, 1966 p. 24 Giant Lighters at top right.

Primary Examiner—A. Hugo Word
Assistant Examiner—Jennifer Register

Attorney, Agent, or Firm—Trexler, Bushnell, Giangiorgi & Blackstone, Ltd.

[57] **CLAIM**

The ornamental design for a biker lighter, as shown and described.

DESCRIPTION

FIG. 1 is a perspective view of the biker lighter design shown in full lines, with the broken lines illustrating a linked chain with which the design may be used, but which forms no part of the claimed design;

FIG. 2 is a left side elevational view of the biker lighter of the present invention; the right side elevational view being a mirror image thereof;

FIG. 3 is a front elevational view thereof;

FIG. 4 is a rear elevational view thereof;

FIG. 5 is a top plan view thereof;

FIG. 6 is a bottom plan view thereof; and,

FIG. 7 is a perspective view thereof showing the design in an open position.

1 Claim, 1 Drawing Sheet

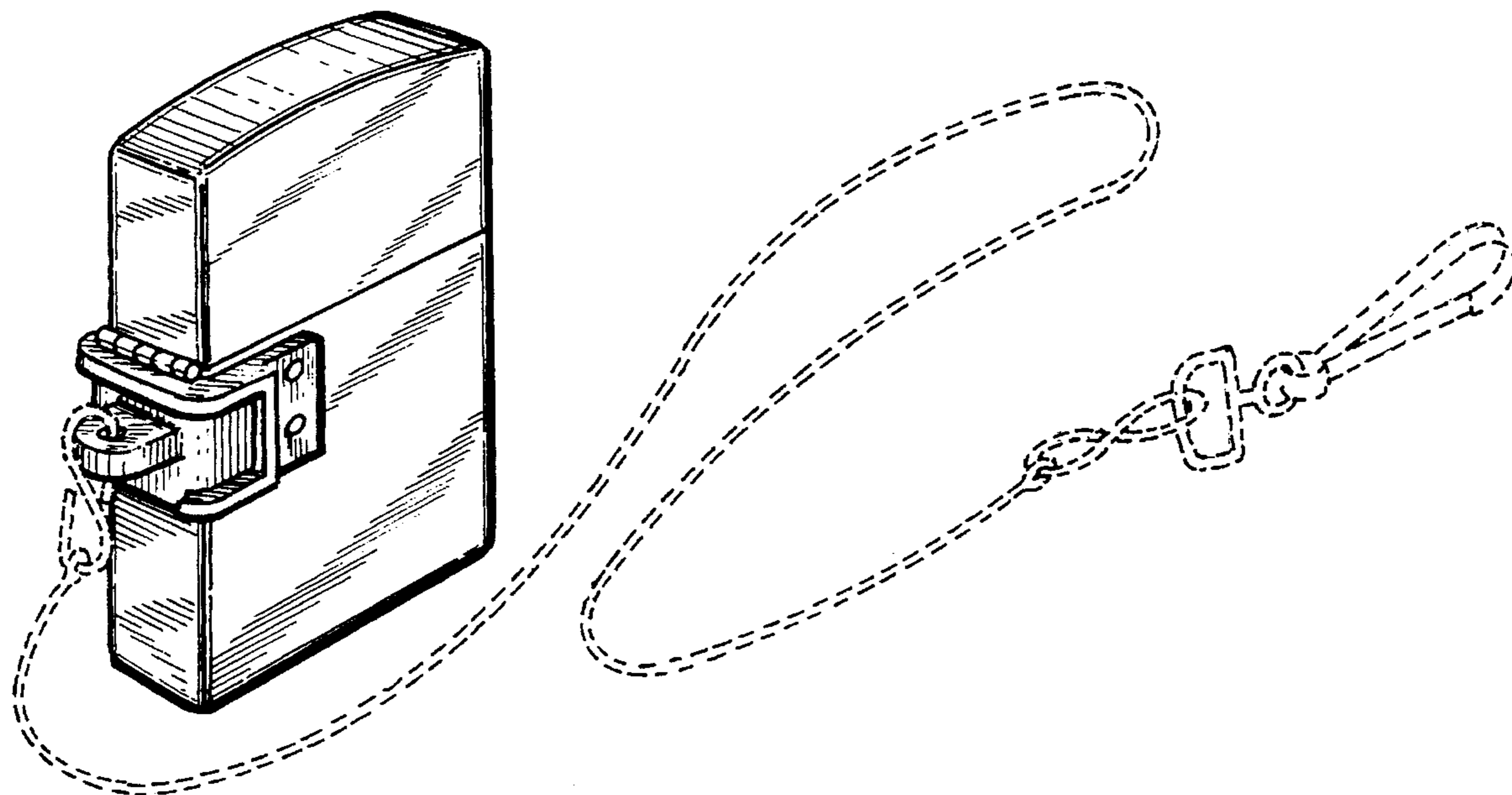

FIG. 1

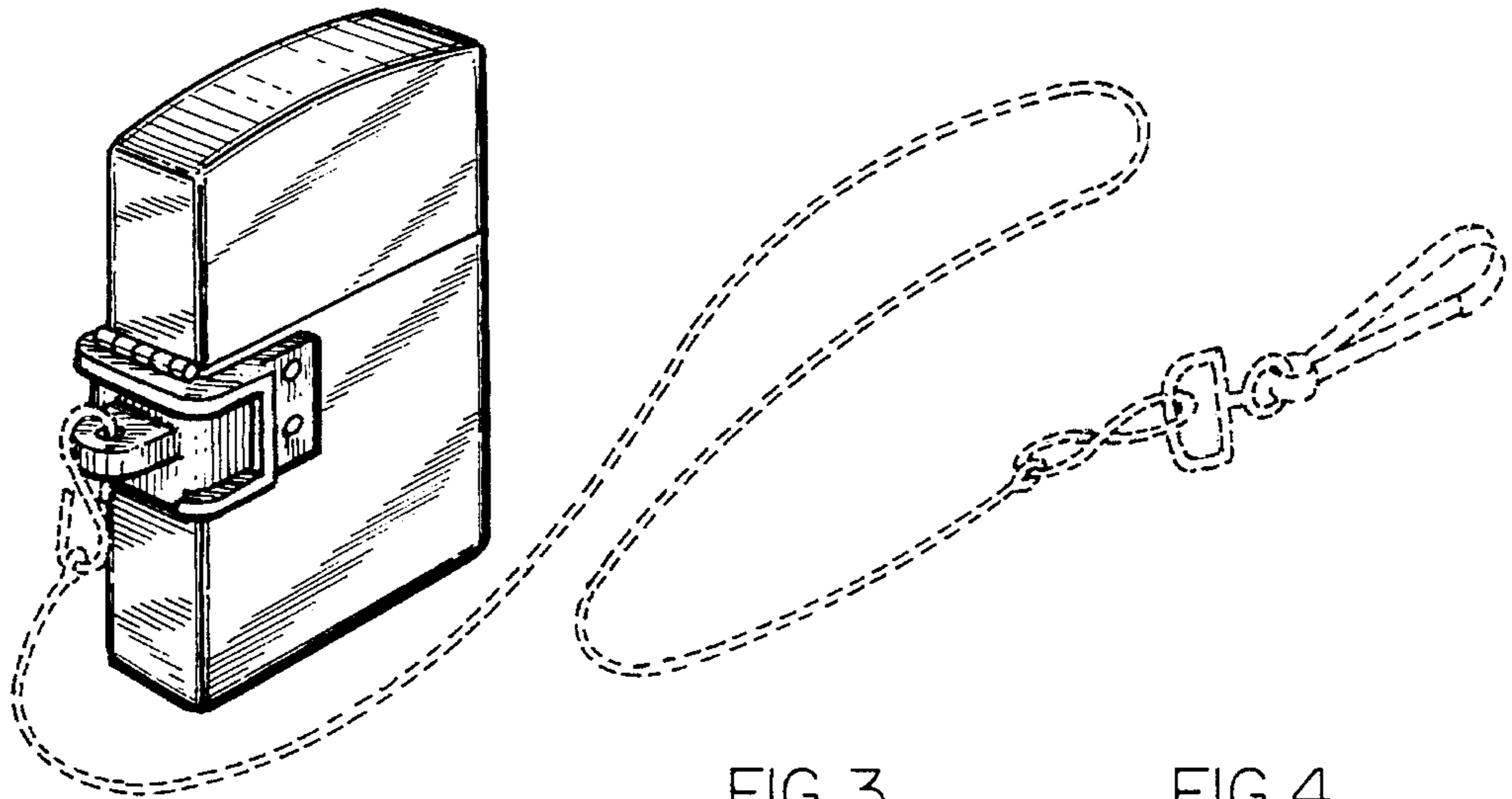

FIG. 2

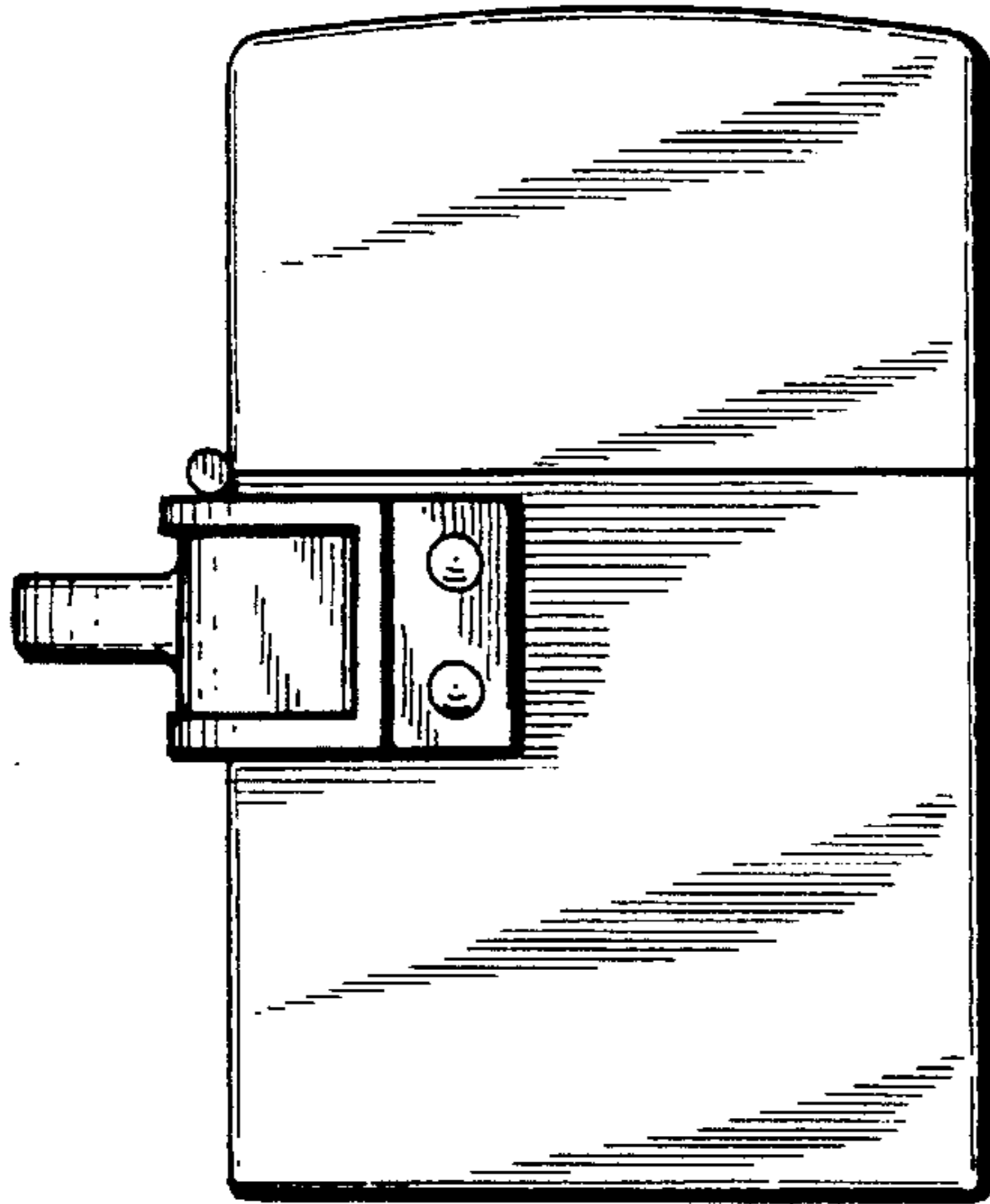

FIG. 3

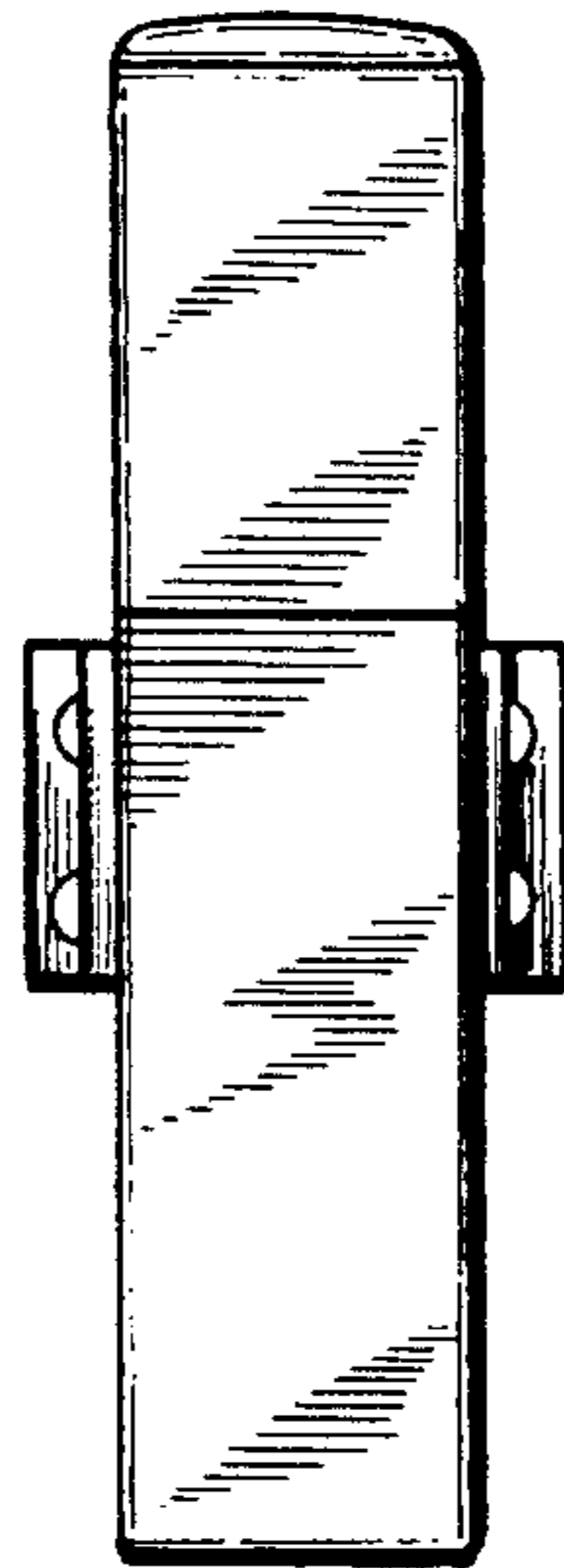

FIG. 4

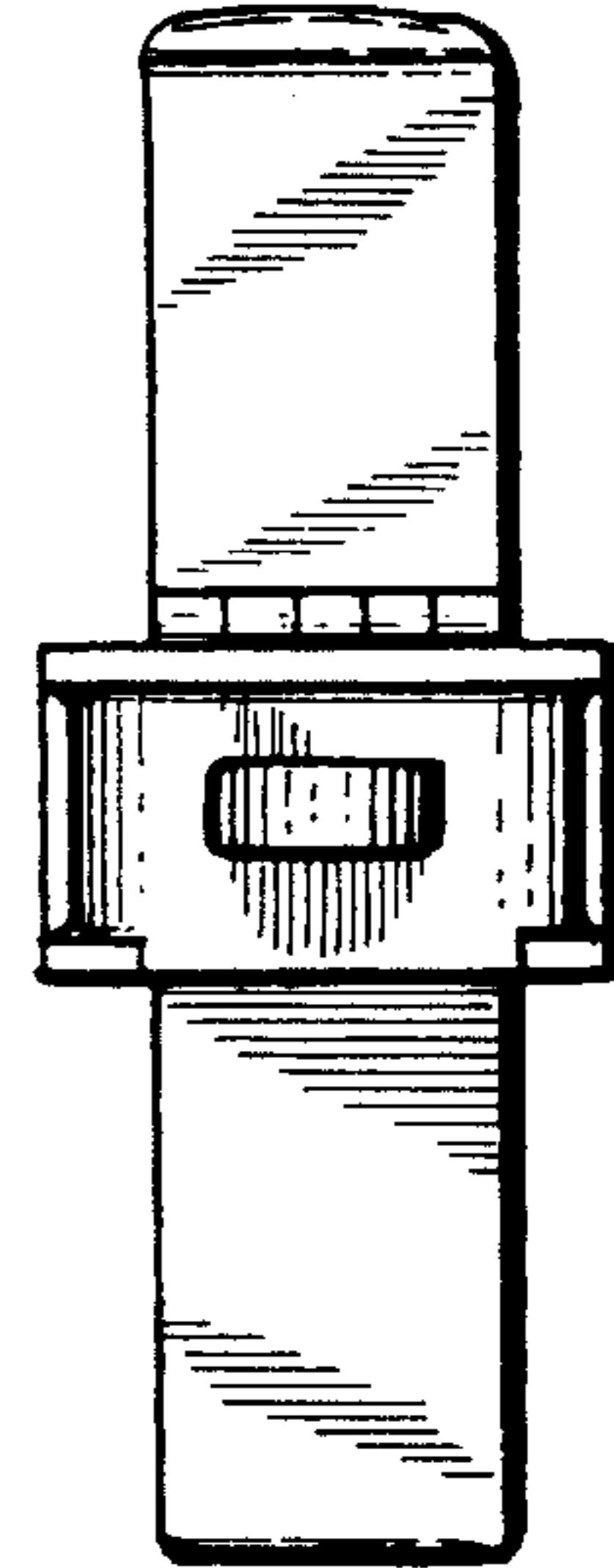

FIG. 5

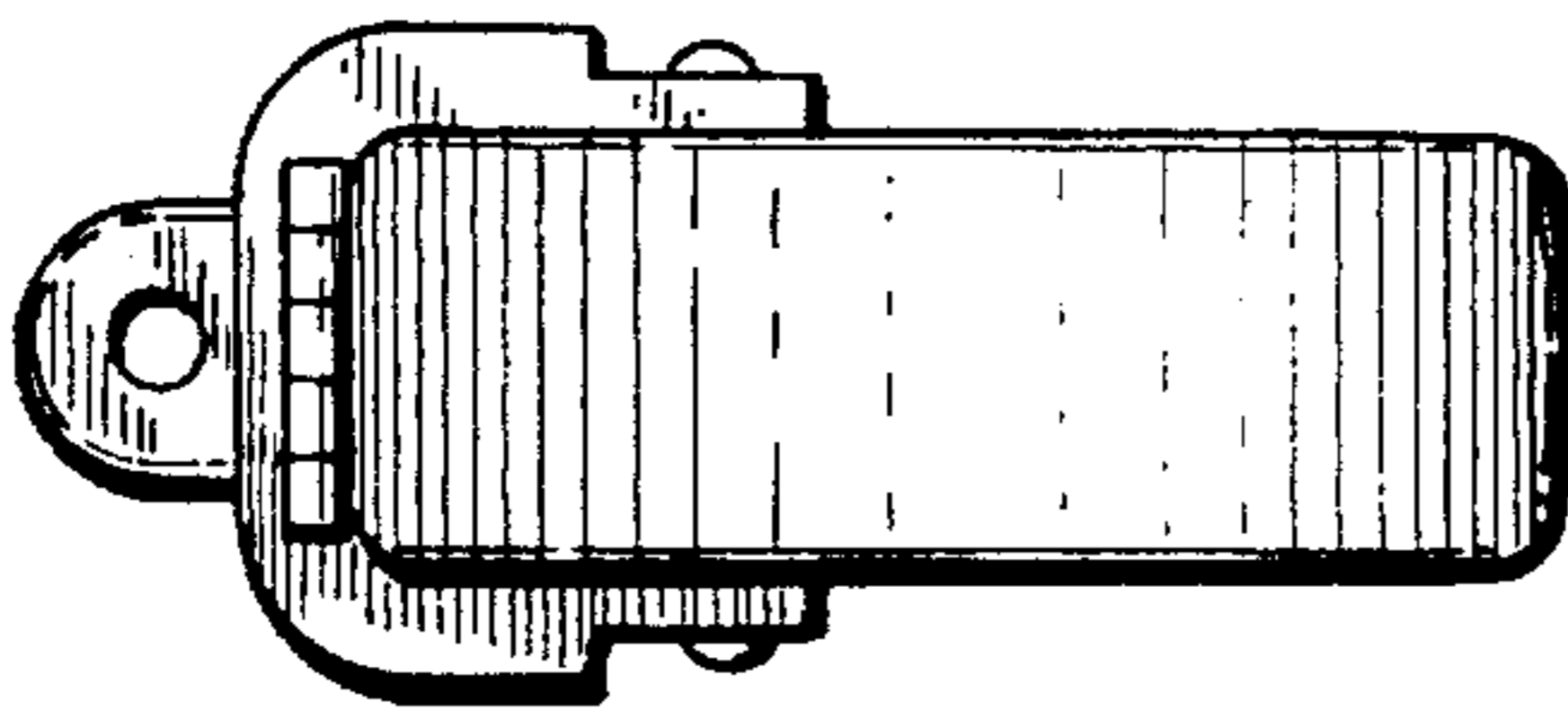

FIG. 6

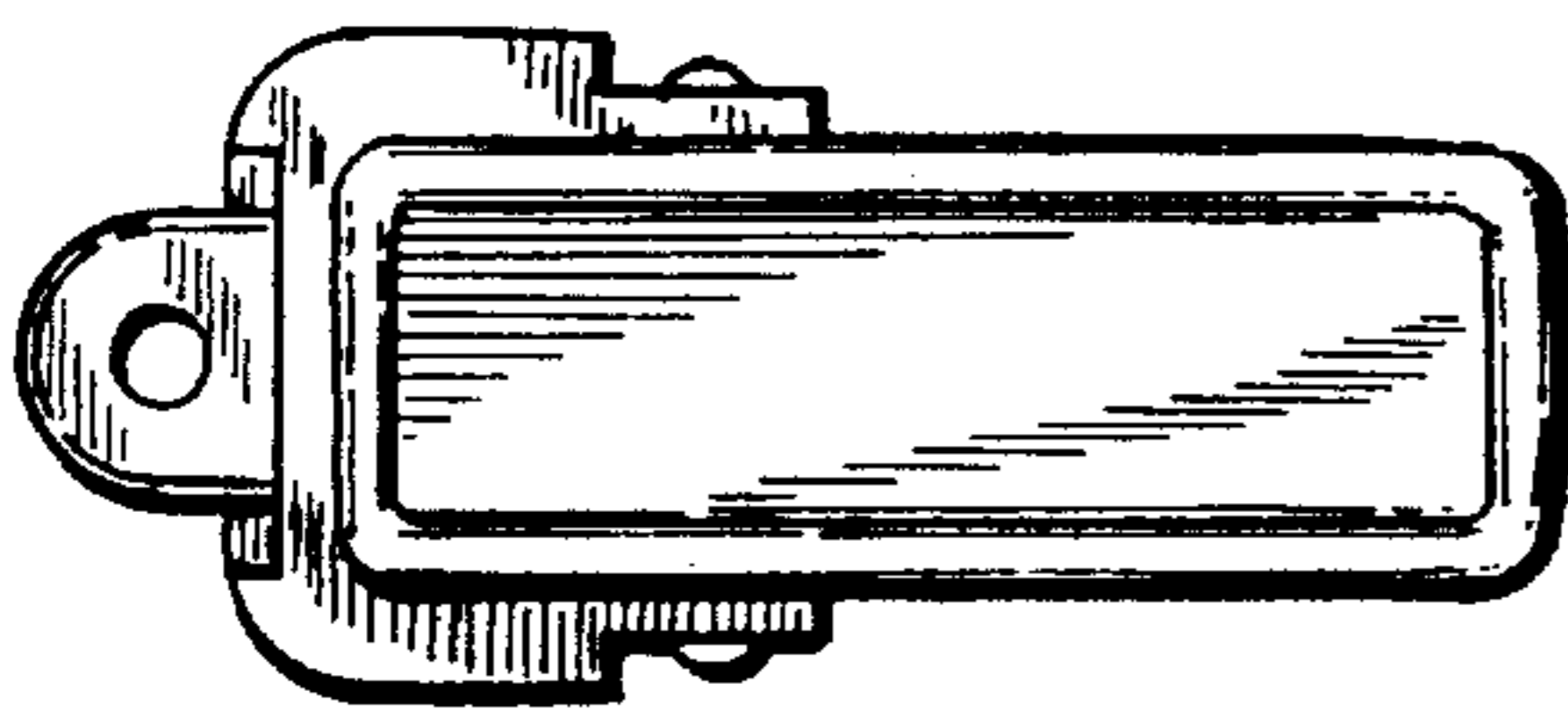

FIG. 7

