



US00D373438S

United States Patent [19]

McCann-Compton et al.

[11] Patent Number: **Des. 373,438**

[45] Date of Patent: ****Sep. 3, 1996**

[54] **DESK LAMP**

[75] Inventors: **Kelly J. McCann-Compton**, Grand Haven; **Thomas M. Edwards**, Spring Lake, both of Mich.

[73] Assignee: **Light Corporation**, Grand Haven, Mich.

[**] Term: **14 Years**

[21] Appl. No.: **28,628**

[22] Filed: **Oct. 11, 1994**

[52] U.S. Cl. **D26/65**

[58] Field of Search D26/60-66; 362/269, 362/274, 275, 285, 413, 418, 419, 427

[56] References Cited

U.S. PATENT DOCUMENTS

D. 327,133	6/1992	Copeland	D26/65
4,314,319	2/1982	Terry et al.	.	
4,494,177	1/1985	Matthews	.	
4,892,278	1/1990	Huang	.	
4,975,815	12/1990	Lin	362/269
5,016,153	5/1991	Gismondi et al.	362/413 X
5,045,986	9/1991	Lin	362/413
5,050,054	9/1991	Hsu	.	
5,097,400	3/1992	Cvek	362/287

5,303,136	4/1994	Brown	.	
5,333,103	7/1994	Cvek	362/413

FOREIGN PATENT DOCUMENTS

67711	1/1991	Canada	D26/65
-------	--------	--------	-------	--------

OTHER PUBLICATIONS

Home Lighting & Accessories, Aug. 1981, p. 54.

Primary Examiner—Susan J. Lucas
Attorney, Agent, or Firm—Warner Norcross & Judd

[57] CLAIM

The ornamental design for a desk lamp, as shown and described.

DESCRIPTION

FIG. 1 is a front and side perspective view thereof;
 FIG. 2 is a front elevational view thereof;
 FIG. 3 is a top view thereof;
 FIG. 4 is a left side elevational view thereof, the right side being a mirror image thereof;
 FIG. 5 is a rear elevational view thereof; and,
 FIG. 6 is a bottom view thereof; and,
 FIG. 7 is a fragmentary bottom perspective view thereof, the support arm being fragmentarily shown for convenience of illustration.

1 Claim, 5 Drawing Sheets

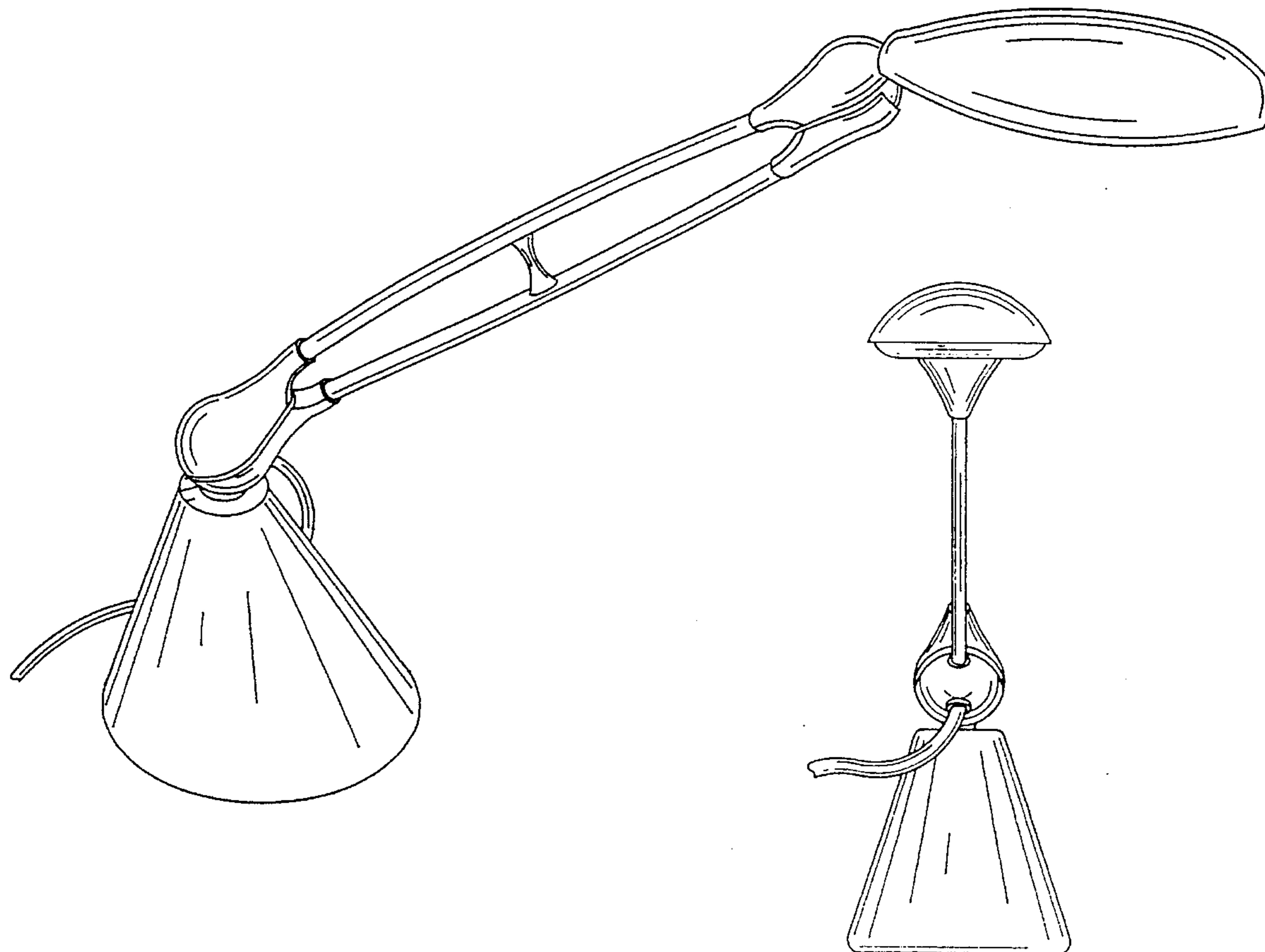

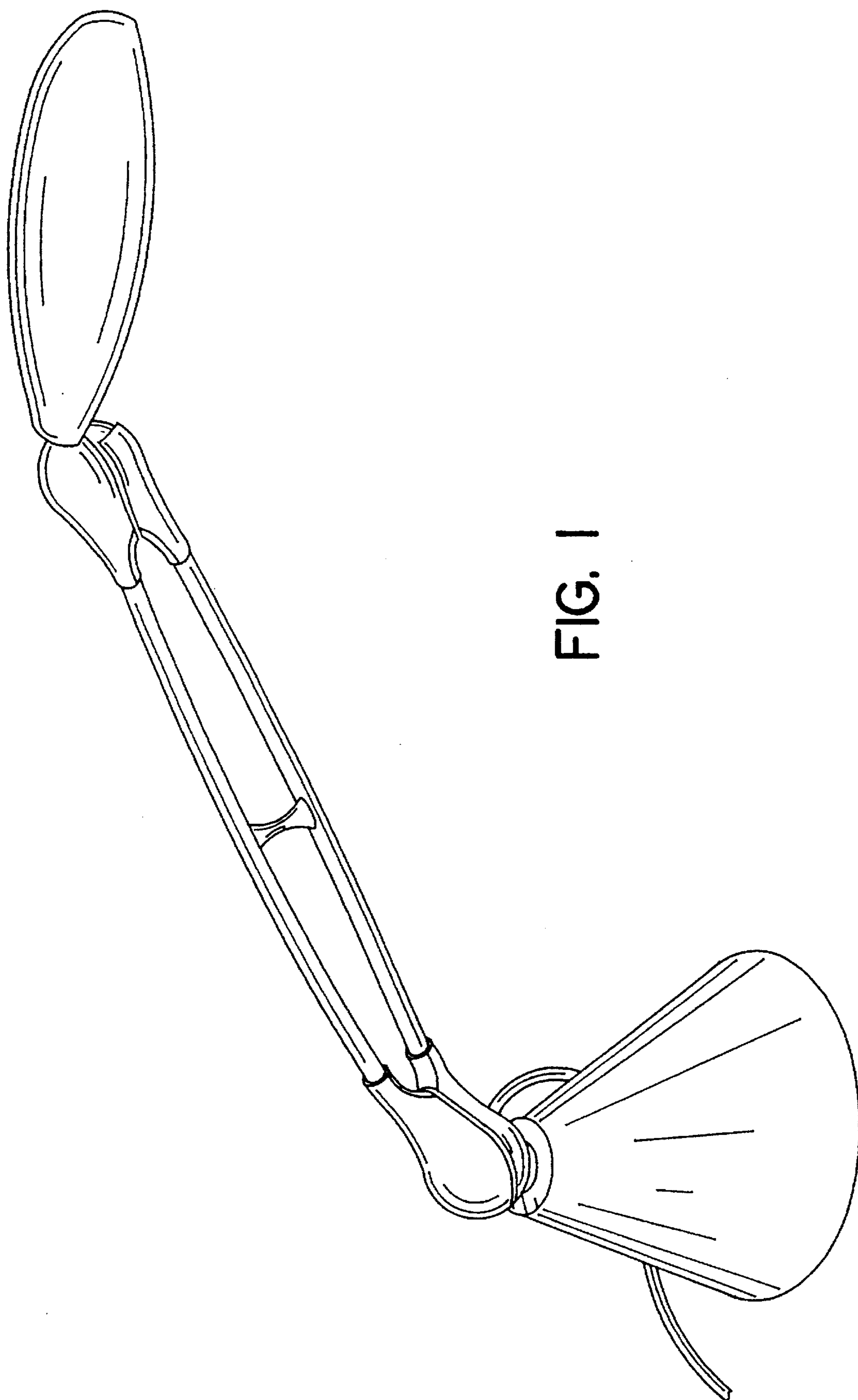

FIG. 1

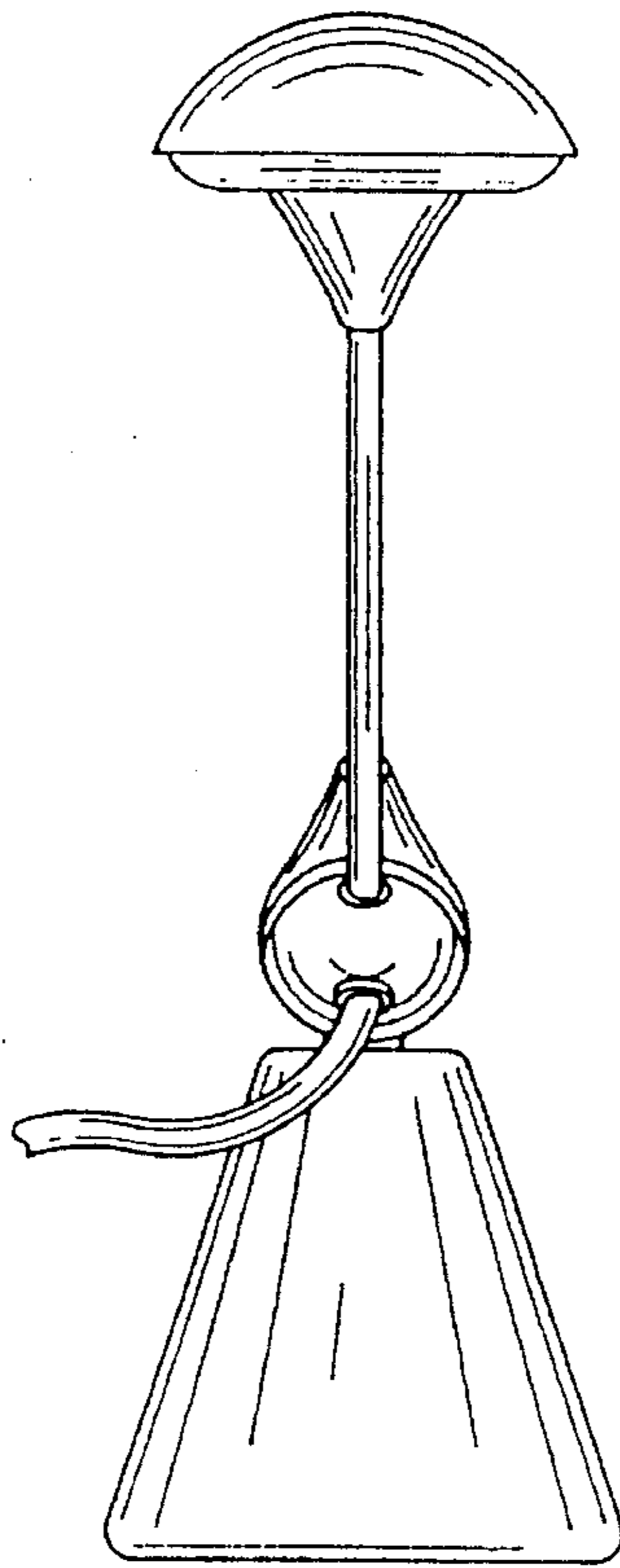

FIG. 2

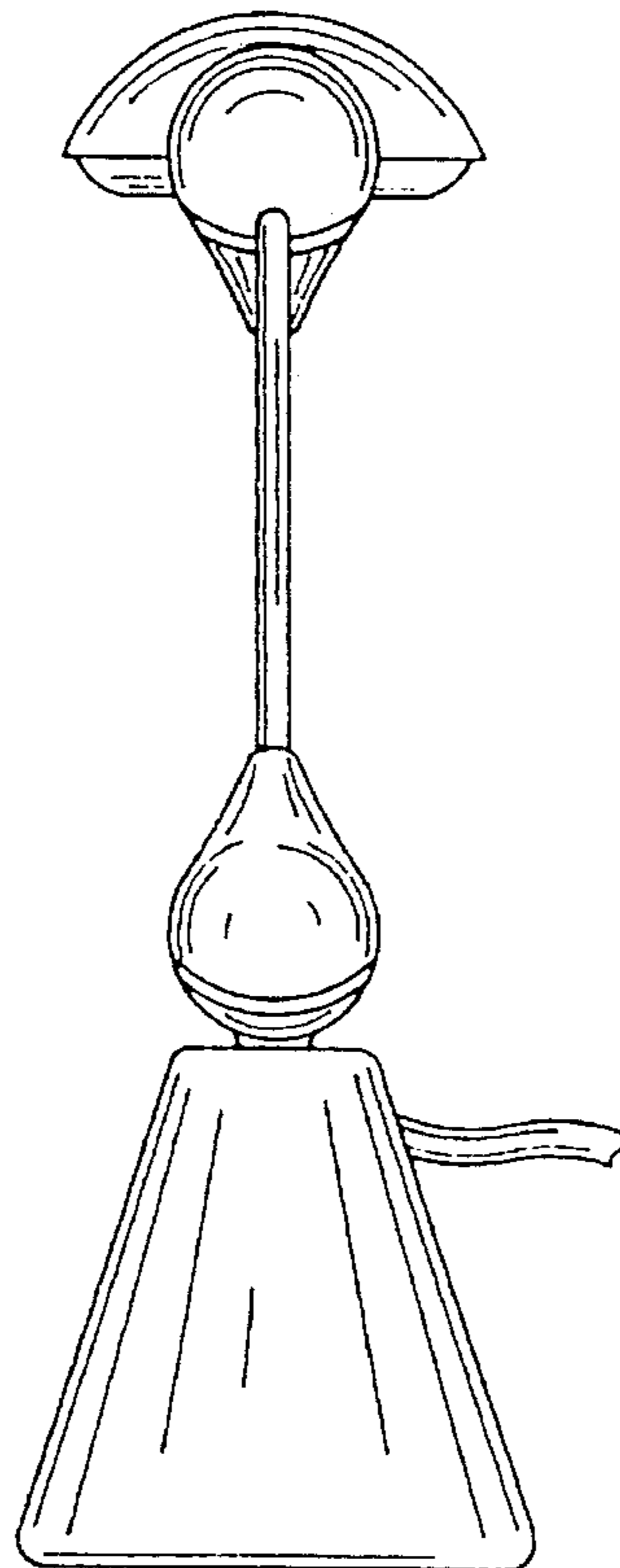

FIG. 5

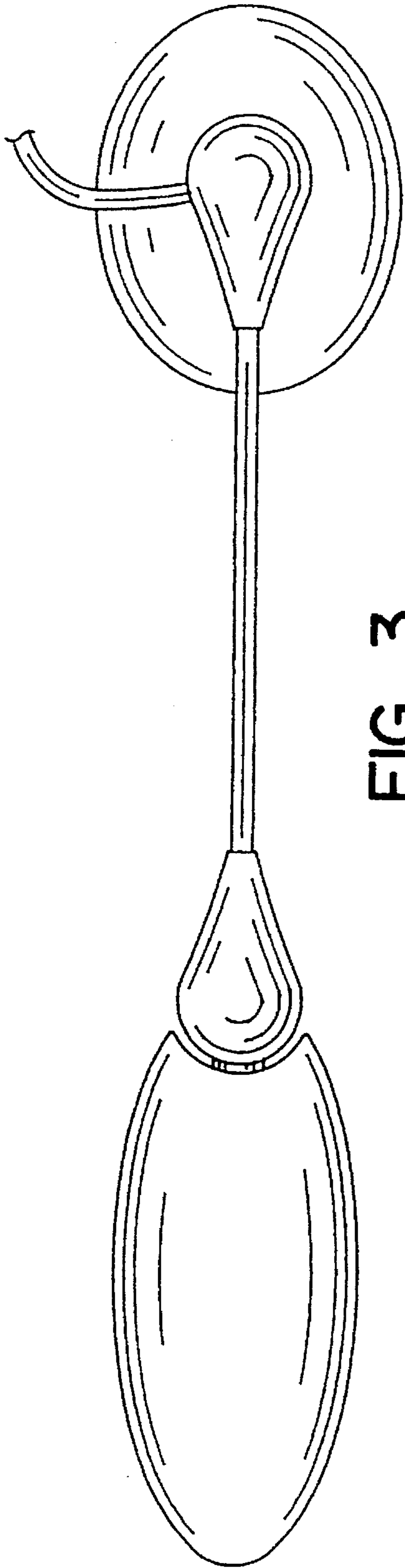

FIG. 3

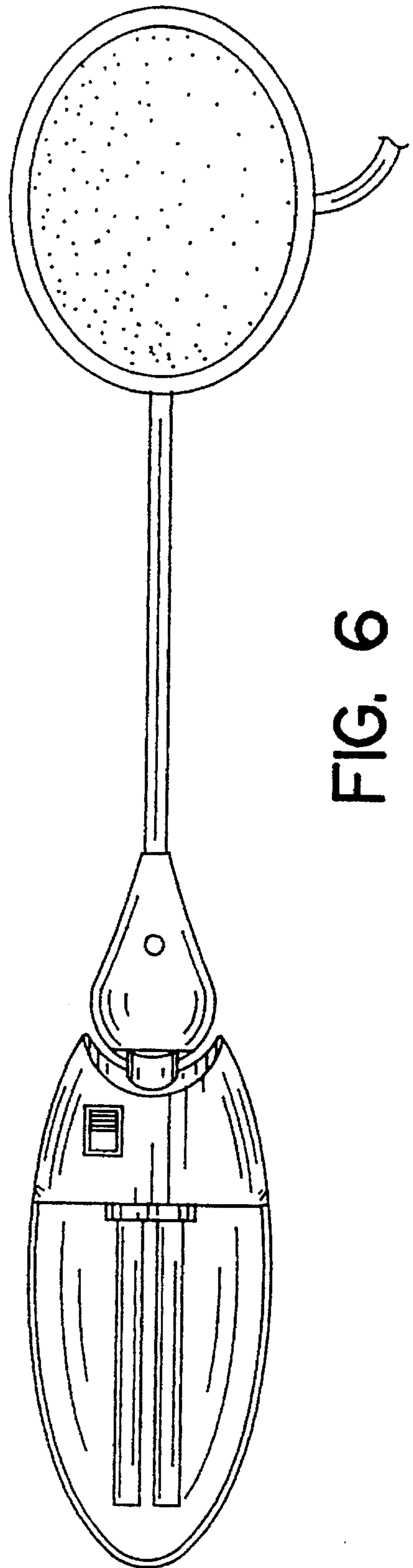

FIG. 6

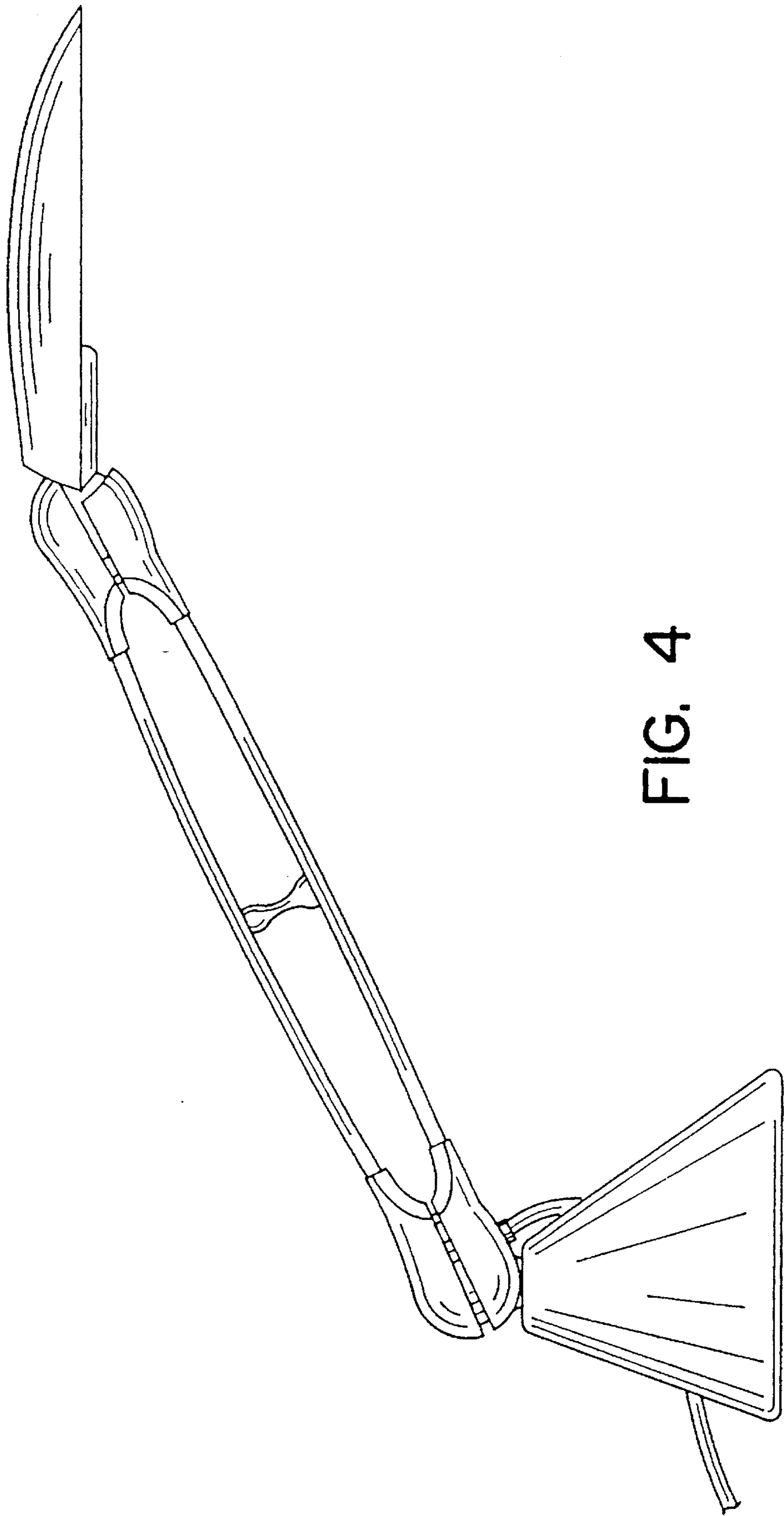

FIG. 4

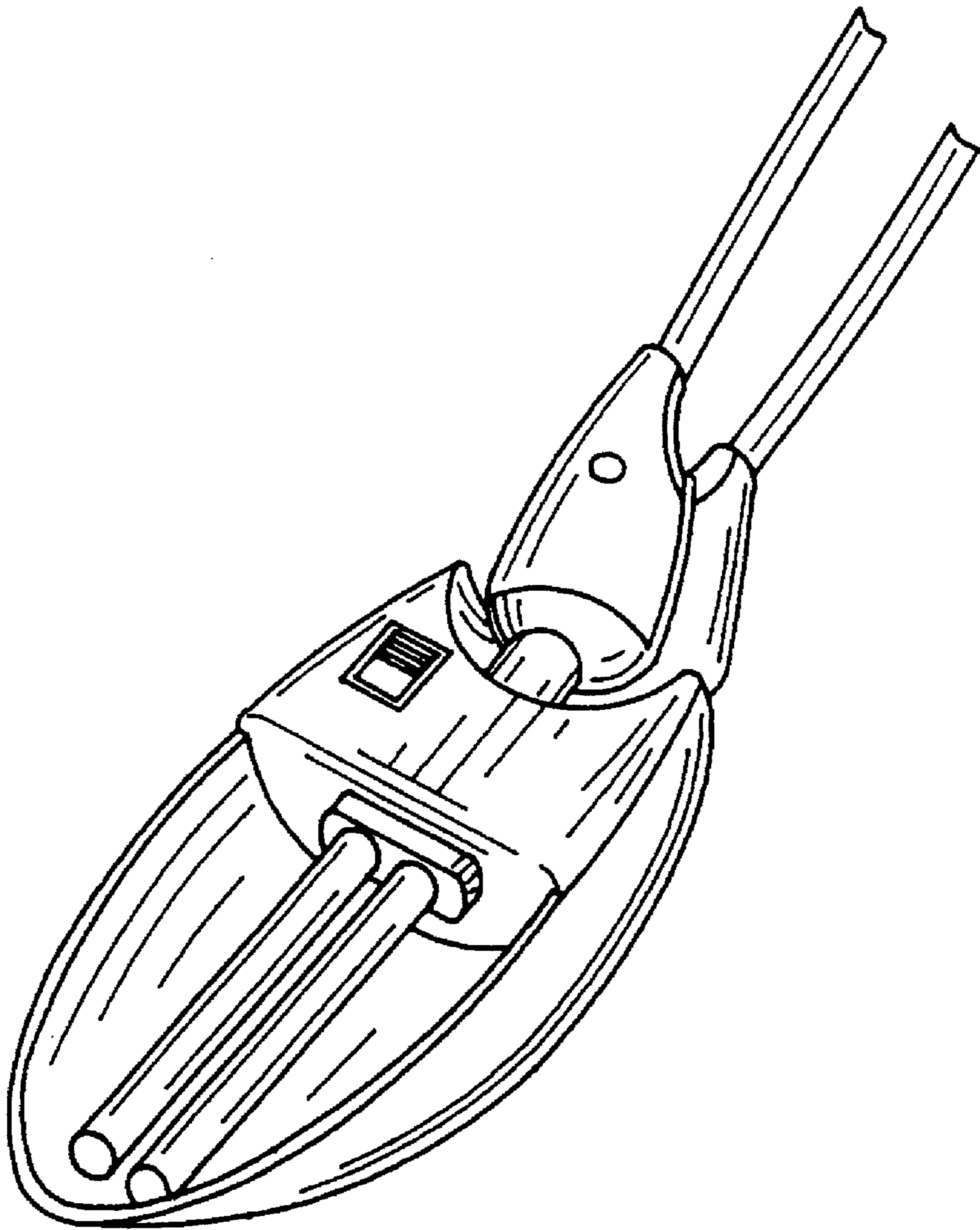

FIG. 7