



US00D373266S

United States Patent [19]

[11] Patent Number: **Des. 373,266**

Pellenberg et al.

[45] Date of Patent: ****Sep. 3, 1996**

[54] **INTERACTIVE INFORMATION KIOSK ASSEMBLY**

D. 344,505	2/1994	Traldi	D20/10 X
3,405,985	10/1968	Higer	312/114
4,827,439	5/1989	Licht	364/708.1 X

[75] Inventors: **Alan Pellenberg; Thomas A. Lamar, III**, both of Atlanta; **David L. Wikle**, Smyrna; **W. Glenn Nix**, Duluth; **Stephen Jaworski, Jr.**, Smyrna, all of Ga.

Primary Examiner—Alan P. Douglas
Assistant Examiner—S. Snapp
Attorney, Agent, or Firm—Hopkins & Thomas

[73] Assignee: **Miller/Zell, Inc.**, Atlanta, Ga.

[**] Term: **14 Years**

[57] **CLAIM**

The ornamental design for an interactive information kiosk assembly, as shown and described.

[21] Appl. No.: **33,841**

DESCRIPTION

[22] Filed: **Jan. 20, 1995**

[52] U.S. Cl. **D6/470**

[58] Field of Search D6/470, 471, 472, D6/474; D20/10, 29, 34, 18, 41; 312/7.2, 114, 116; 211/196; 248/218.4, 441.1; 368/708.1

FIG. 1 is a perspective view of an interactive information kiosk assembly of the present invention; FIG. 2 is a front elevational view of the assembly of FIG. 1; FIG. 3 is a rear elevational view of the assembly of FIG. 1; FIG. 4 is a left side elevational view of the assembly of FIG. 1; FIG. 5 is a top view of the assembly of FIG. 1, and, FIG. 6 is a bottom view of the assembly of FIG. 1.

[56] **References Cited**

U.S. PATENT DOCUMENTS

D. 331,077 11/1992 Foster D20/10

1 Claim, 5 Drawing Sheets

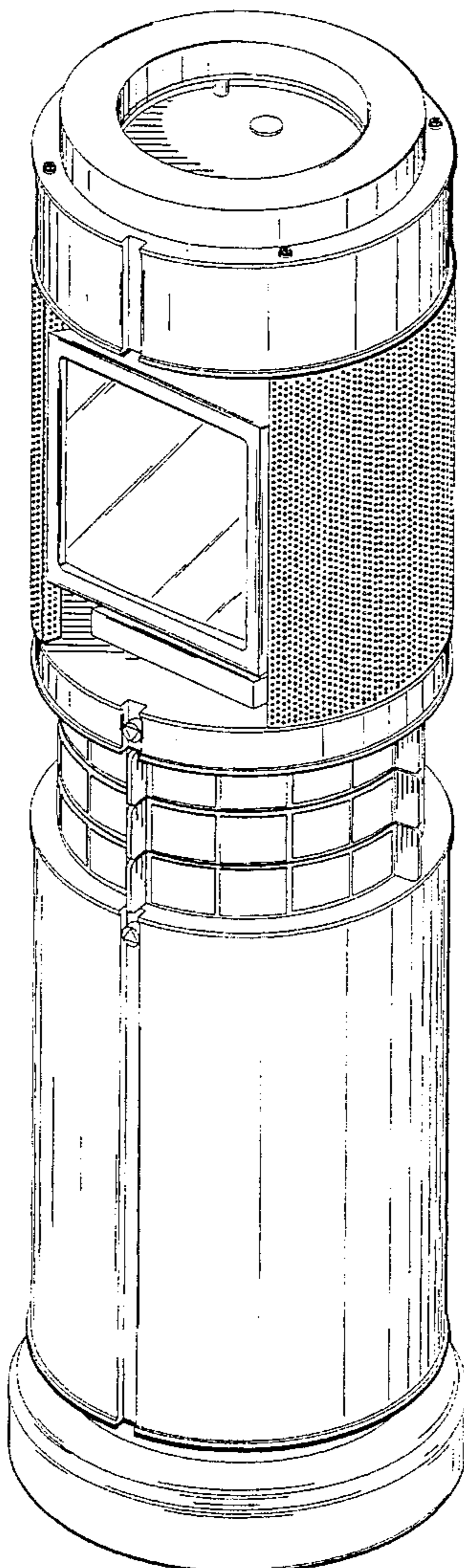

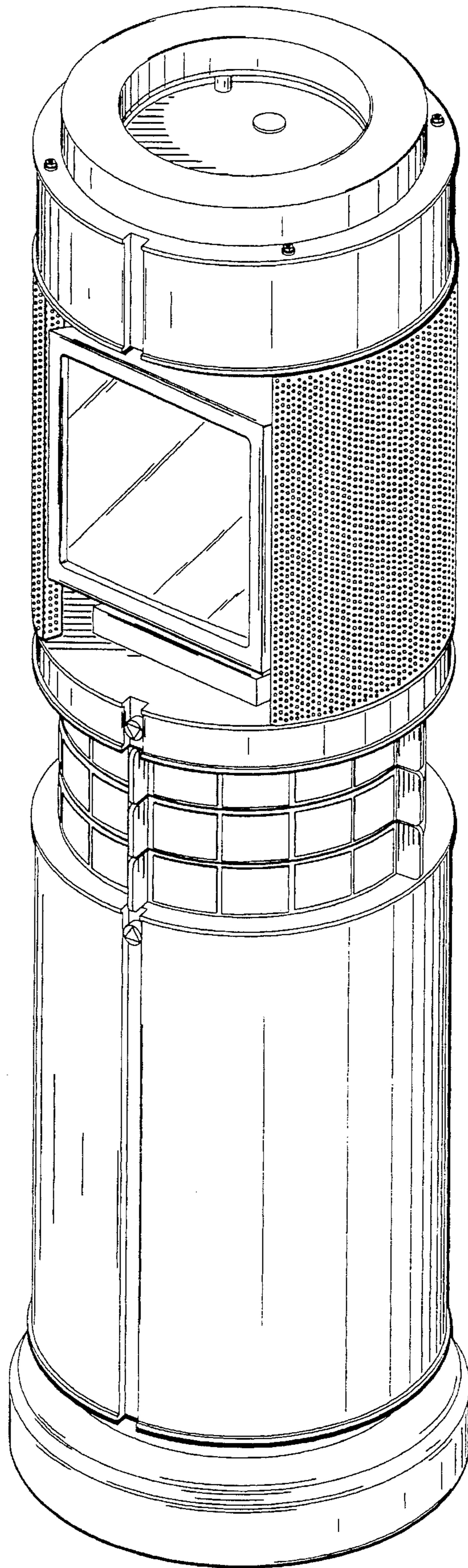

FIG. 1

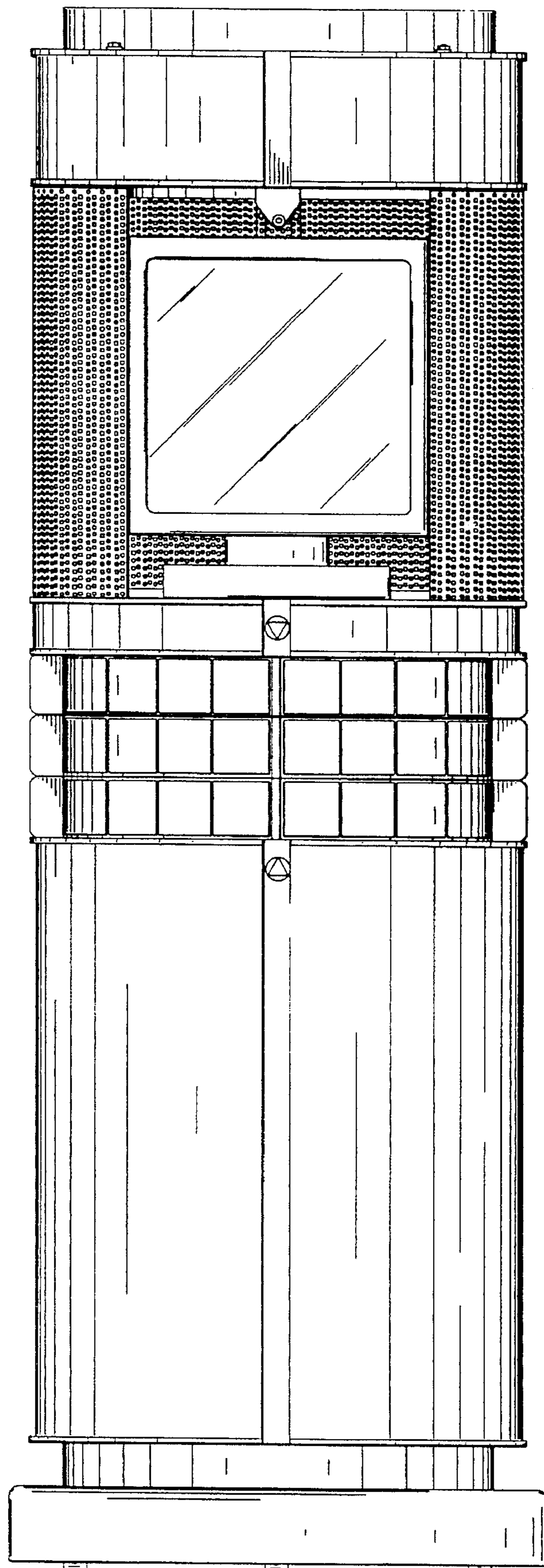

FIG. 2

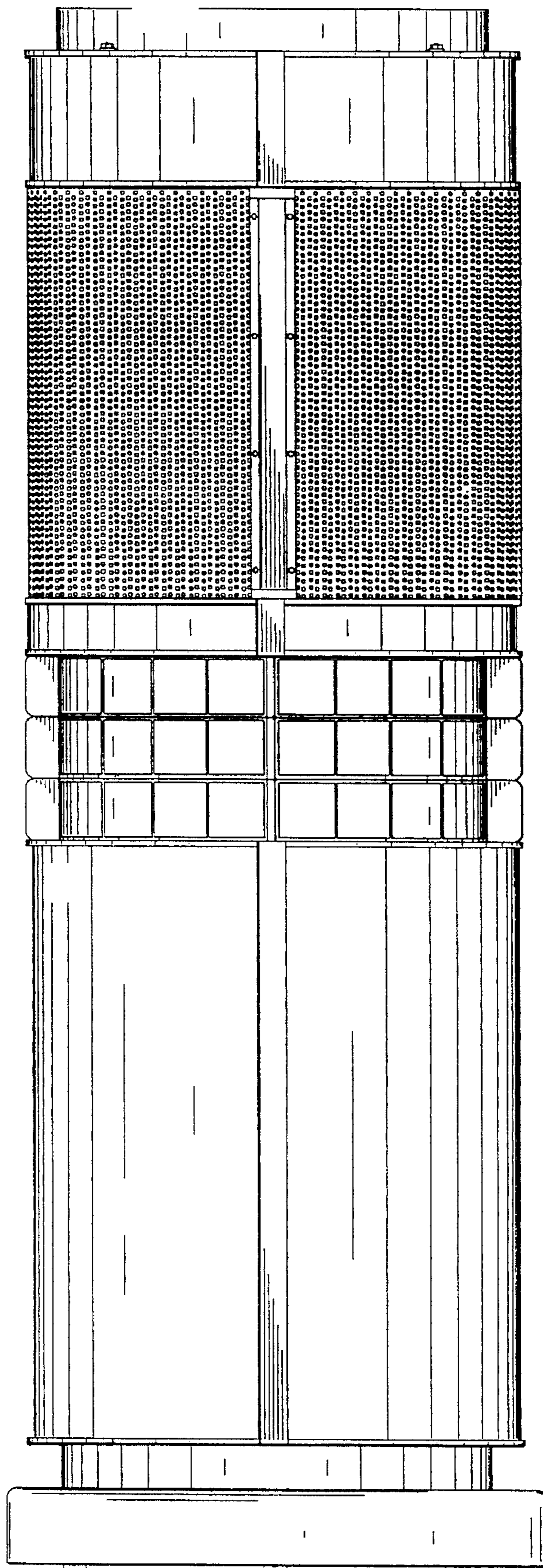

FIG. 3

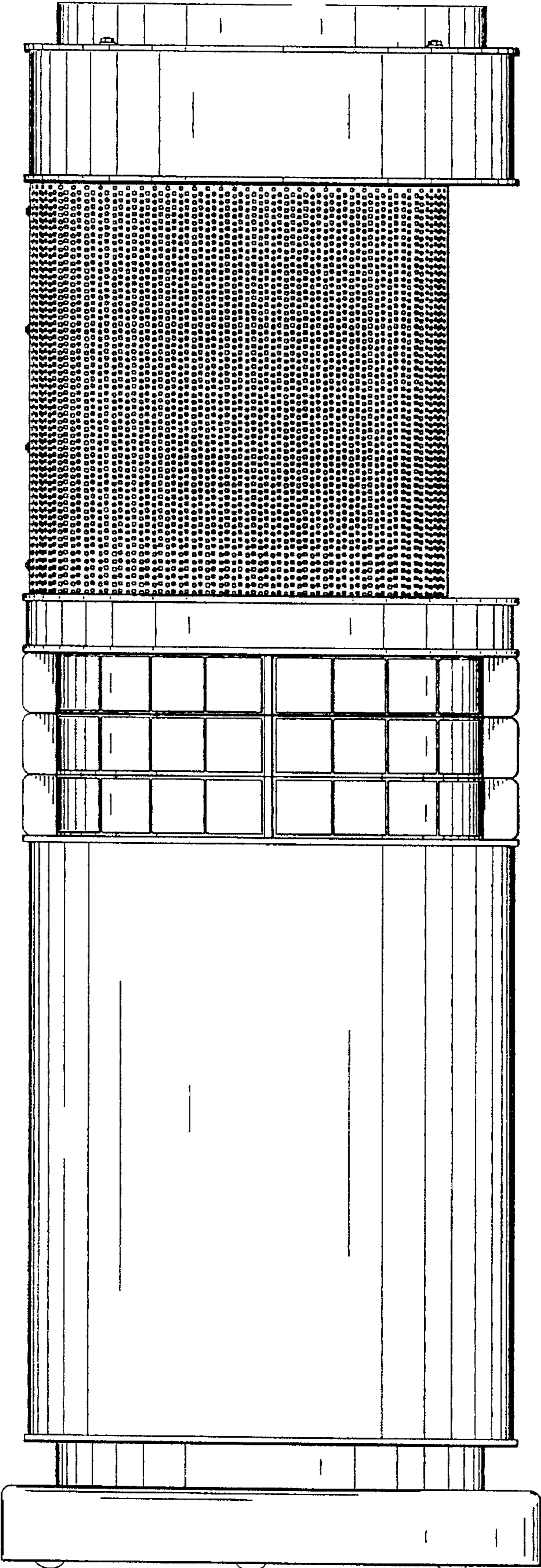

FIG. 4

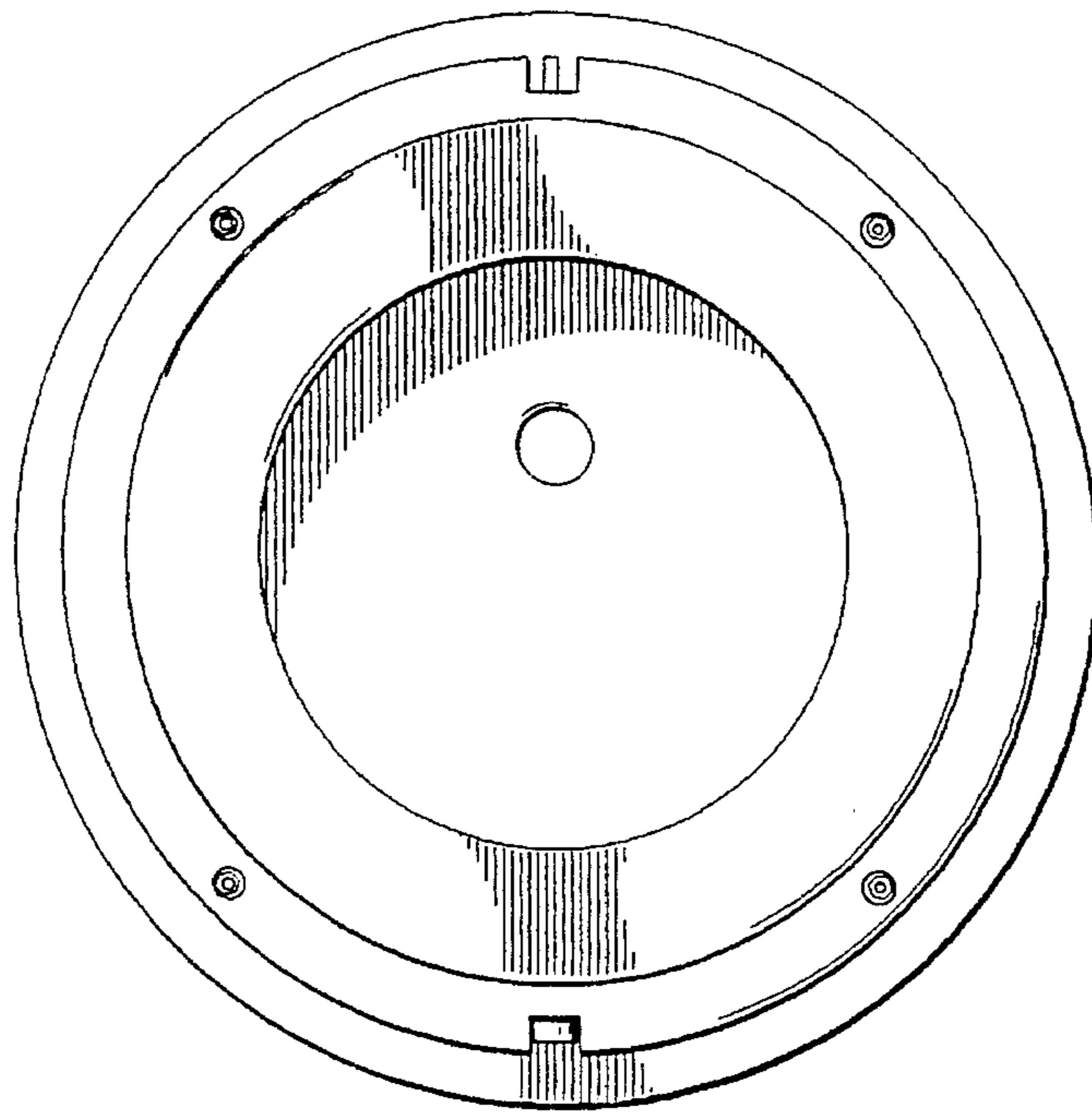

FIG. 5

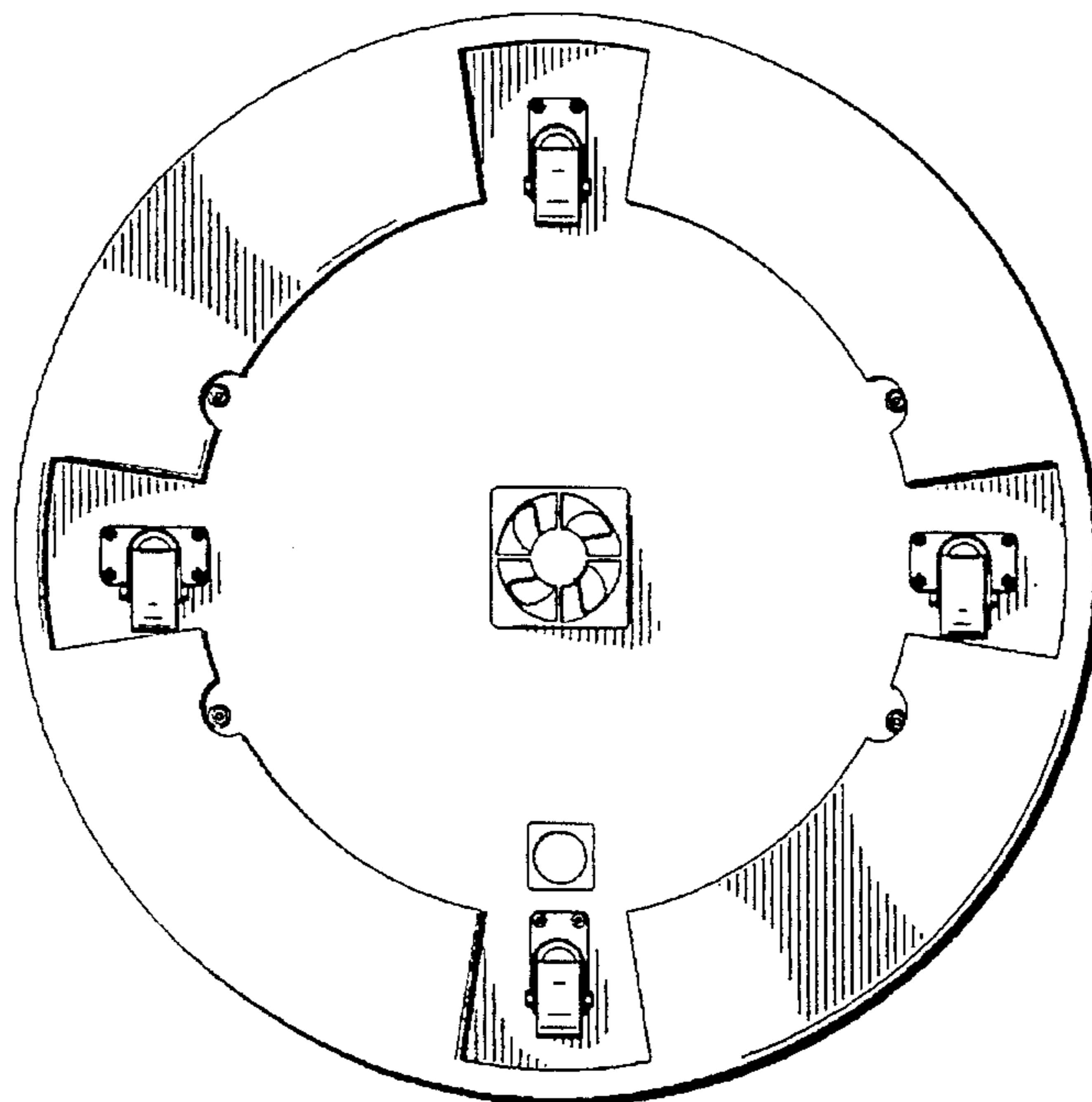

FIG. 6