



US00D373213S

United States Patent [19]
Porter

[11] **Patent Number: Des. 373,213**
[45] **Date of Patent: **Aug. 27, 1996**

[54] **CHANDELIER**
[75] Inventor: **David H. Porter**, Chagrin Falls, Ohio
[73] Assignee: **The L. D. Kichler Co.**, Cleveland, Ohio
[**] Term: **14 Years**
[21] Appl. No.: **29,564**
[22] Filed: **Oct. 11, 1994**
[52] U.S. Cl. **D26/84**
[58] Field of Search **D26/72, 80-92;**
362/147, 404-408

Kichler Lighting catalog supplement S.26, Swiss Passport Sarias; copyright date Jul., 1990, printed in USA.

Primary Examiner—Susan J. Lucas
Attorney, Agent, or Firm—Watts, Hoffmann, Fisher & Heinke

[57] **CLAIM**

The ornamental design for a chandelier, as shown and described.

DESCRIPTION

FIG. 1 is a perspective view of a chandelier showing my new design;
FIG. 2 is a front elevational view thereof, the rear elevational view being a mirror image thereof;
FIG. 3 is a left side elevational view thereof;
FIG. 4 is a right side elevational view thereof;
FIG. 5 is a top plan view thereof; and,
FIG. 6 is a bottom plan view thereof.

[56] **References Cited**
U.S. PATENT DOCUMENTS
D. 304,769 11/1989 De'Armond D26/84
4,924,366 5/1990 Shemitz D26/72 X
OTHER PUBLICATIONS
Thomas Industries Lighting Catalog, 1988, p. 67, Chandelier #2207-1.
Thomas Industries Lighting Catalog, 1988, p. 67, Chandelier #M.2508-1.

1 Claim, 5 Drawing Sheets

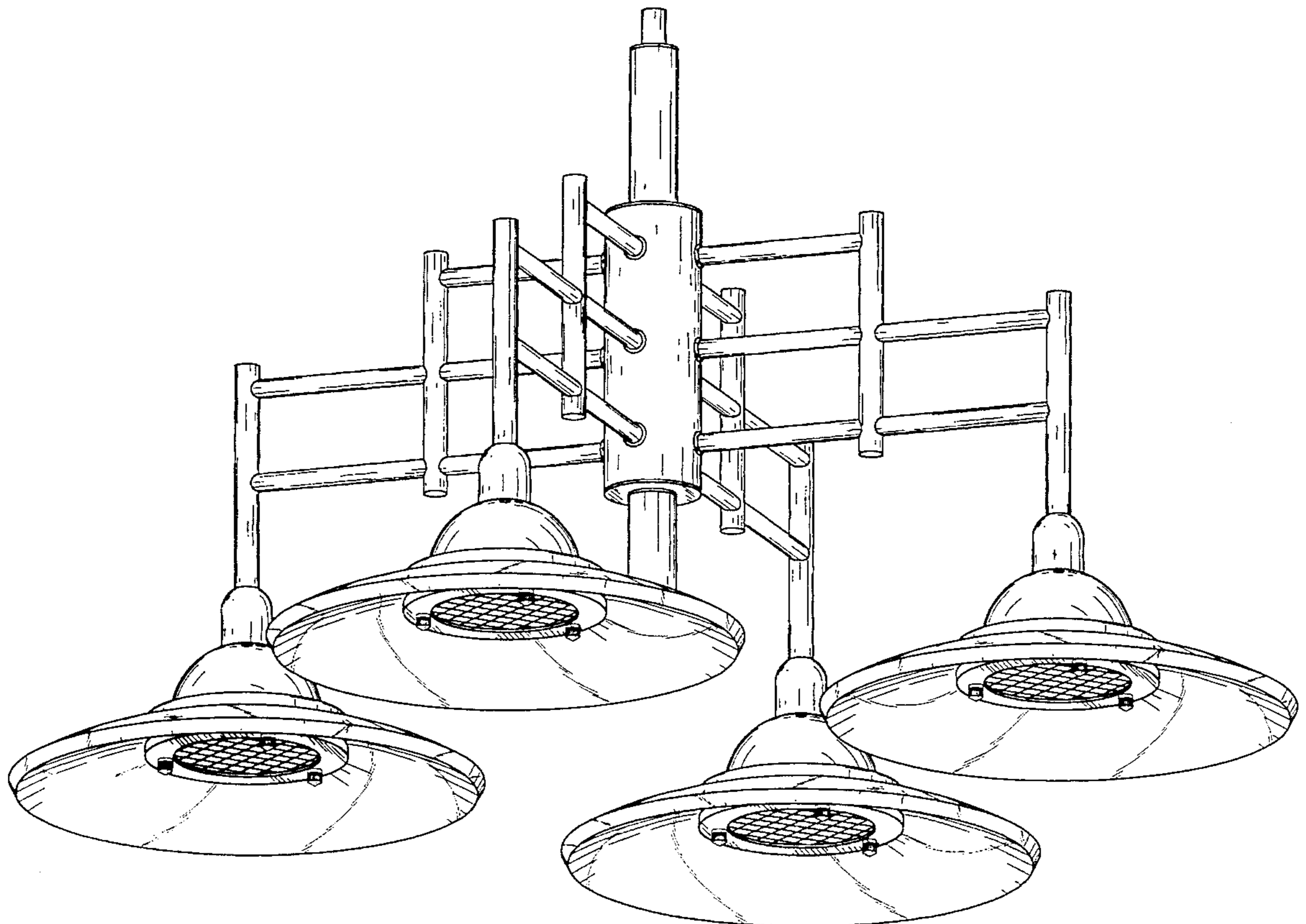

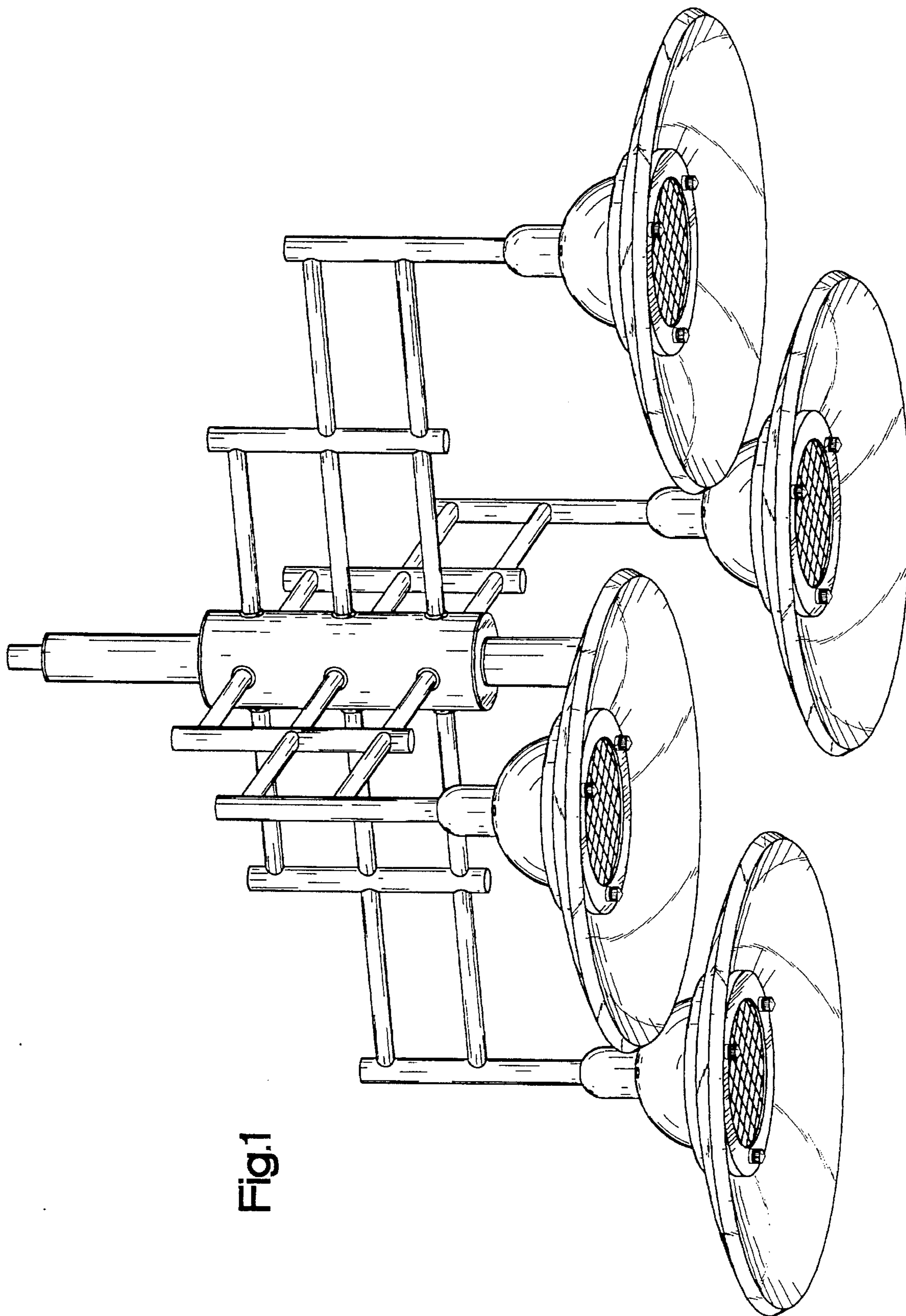

Fig.1

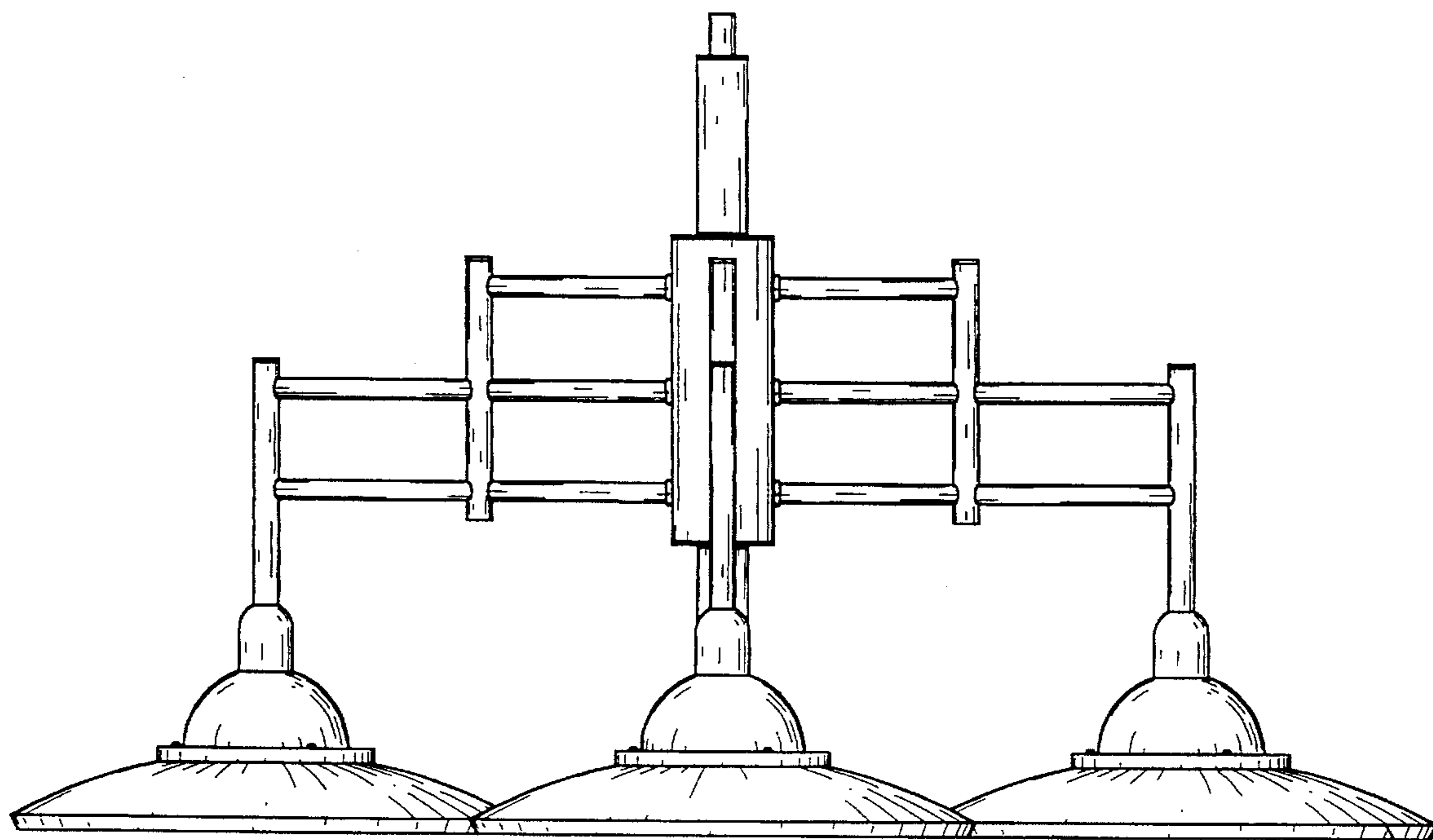

Fig.2

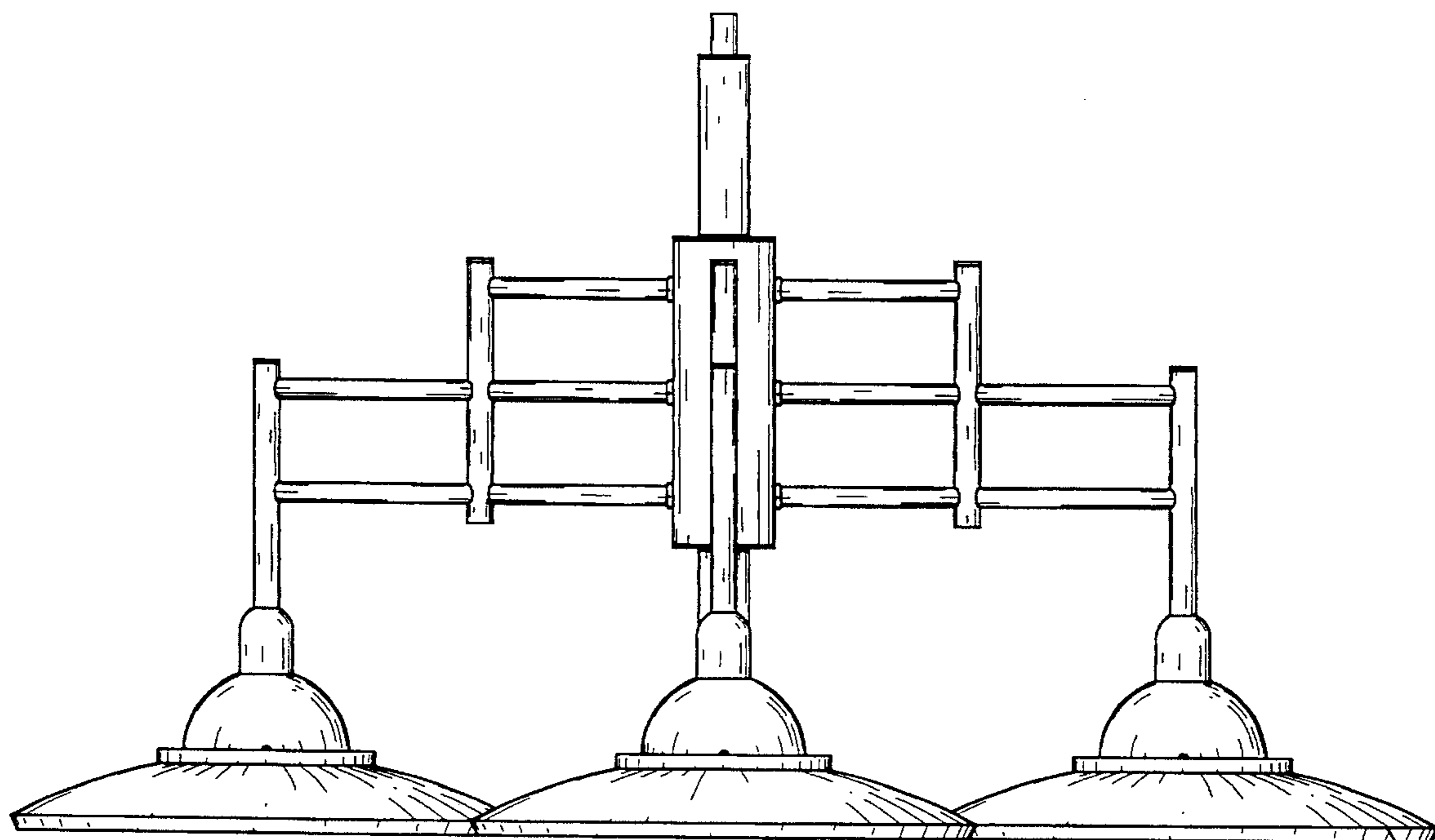

Fig.3

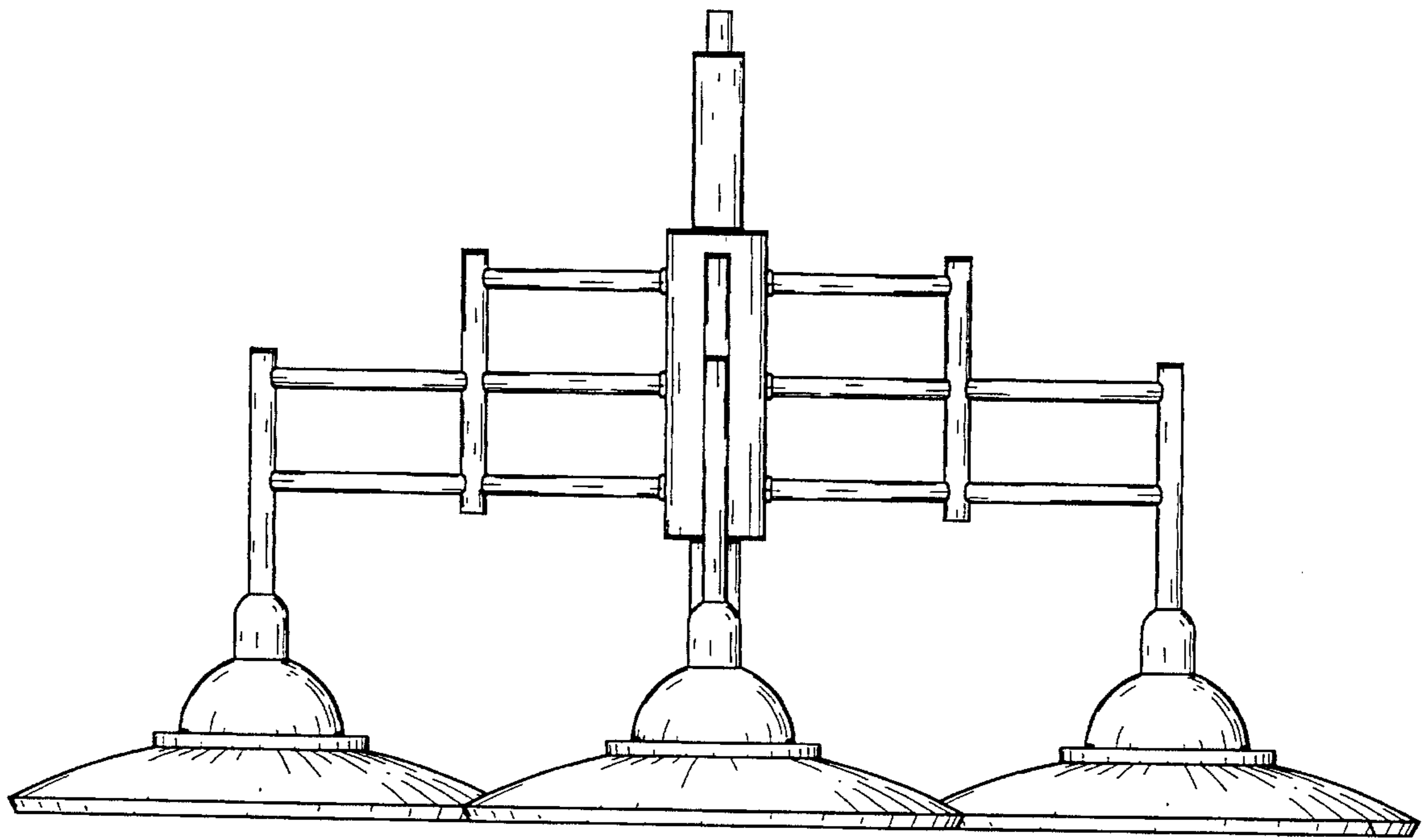

Fig.4

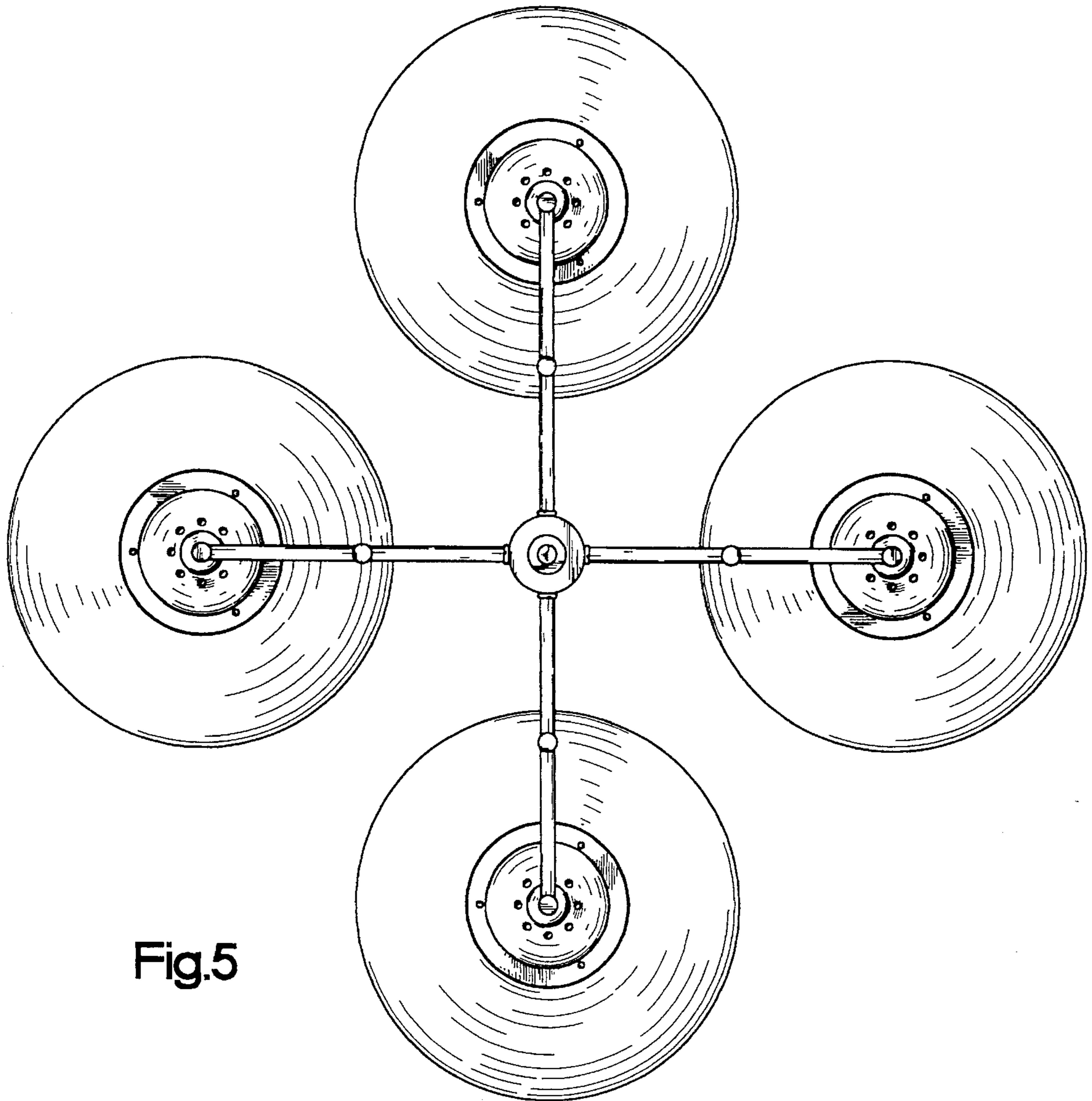

Fig.5

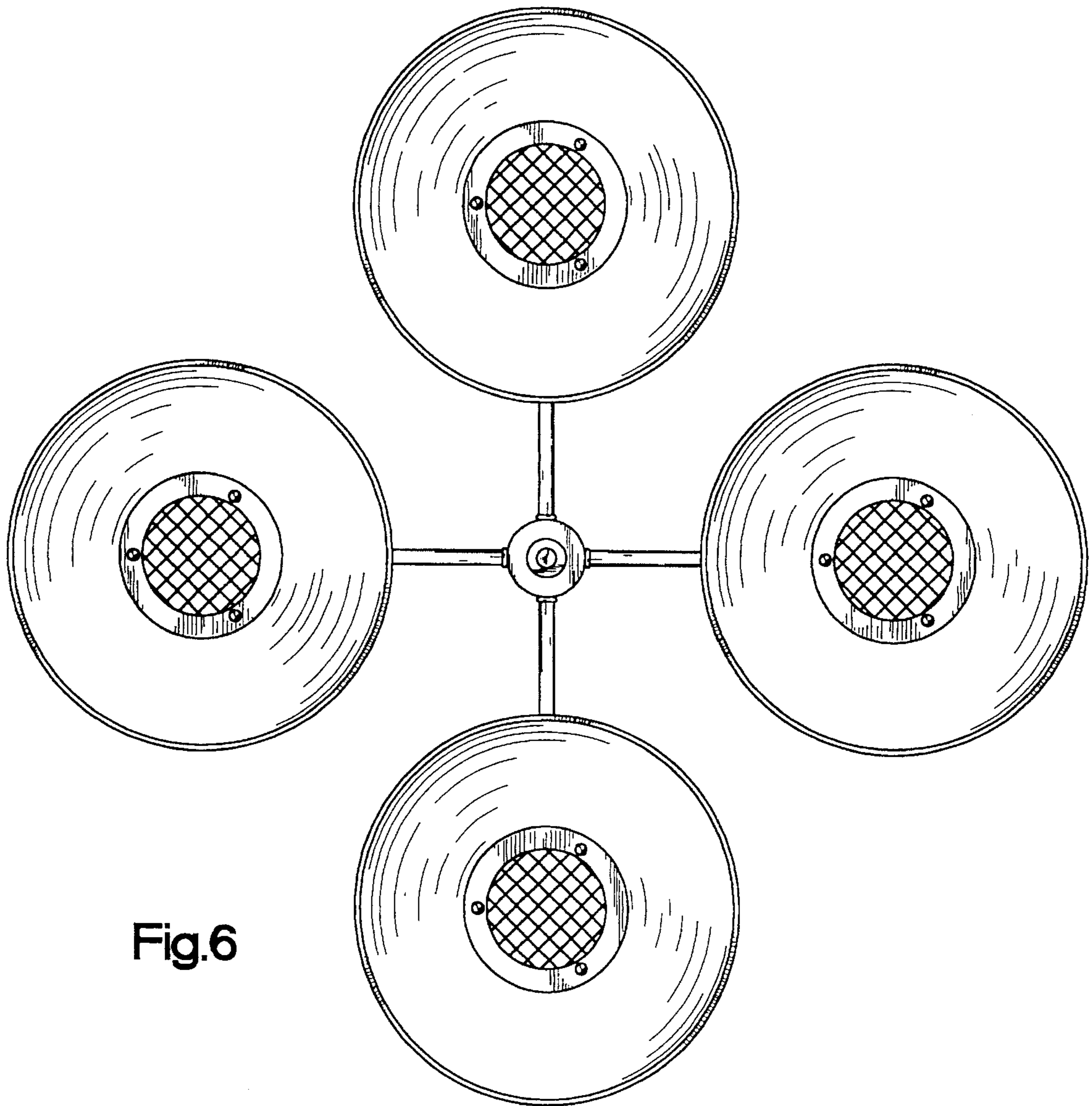

Fig.6