



US00D373207S

# United States Patent [19] Yuen

[11] Patent Number: **Des. 373,207**  
[45] Date of Patent: **\*\*Aug. 27, 1996**

[54] **COMBINED FLASHLIGHT AND RADIO**

D. 302,694 8/1989 Yuen ..... D26/38 X  
3,275,819 9/1966 Laurent ..... 362/183

[75] Inventor: **Se Kit Yuen**, Kowloon, Hong Kong

### FOREIGN PATENT DOCUMENTS

[73] Assignee: **John Manufacturing Limited**,  
Kowloon, Hong Kong

668160 12/1965 Belgium ..... 362/200

[\*\*] Term: **14 Years**

*Primary Examiner*—Susan J. Lucas  
*Attorney, Agent, or Firm*—Darby & Darby, P.C.

[21] Appl. No.: **27,534**

### [57] CLAIM

[22] Filed: **Aug. 24, 1994**

The ornamental design for a combined flashlight and radio, as shown and described.

### [30] Foreign Application Priority Data

### DESCRIPTION

Apr. 7, 1994 [GB] United Kingdom ..... 2038247

[52] U.S. Cl. .... **D26/38**; D14/168

[58] Field of Search ..... D26/37-50, 52;  
D14/168; 362/157, 158, 183, 184, 187,  
188, 189, 190, 191, 194-200, 86, 87; 455/344,  
350, 351

FIG. 1 is a front elevational view a combined flashlight and radio showing my new design;  
FIG. 2 is a rear elevational view thereof;  
FIG. 3 is a top plan view thereof;  
FIG. 4 is a bottom plan view thereof;  
FIG. 5 is a left side elevational view thereof;  
FIG. 6 is a right side elevational view thereof; and,  
FIG. 7 is a perspective view thereof, as viewed from the front.

### [56] References Cited

#### U.S. PATENT DOCUMENTS

D. 154,549 7/1949 Koester ..... D26/38  
D. 237,742 11/1975 Miyamoto ..... D26/38 X

**1 Claim, 4 Drawing Sheets**

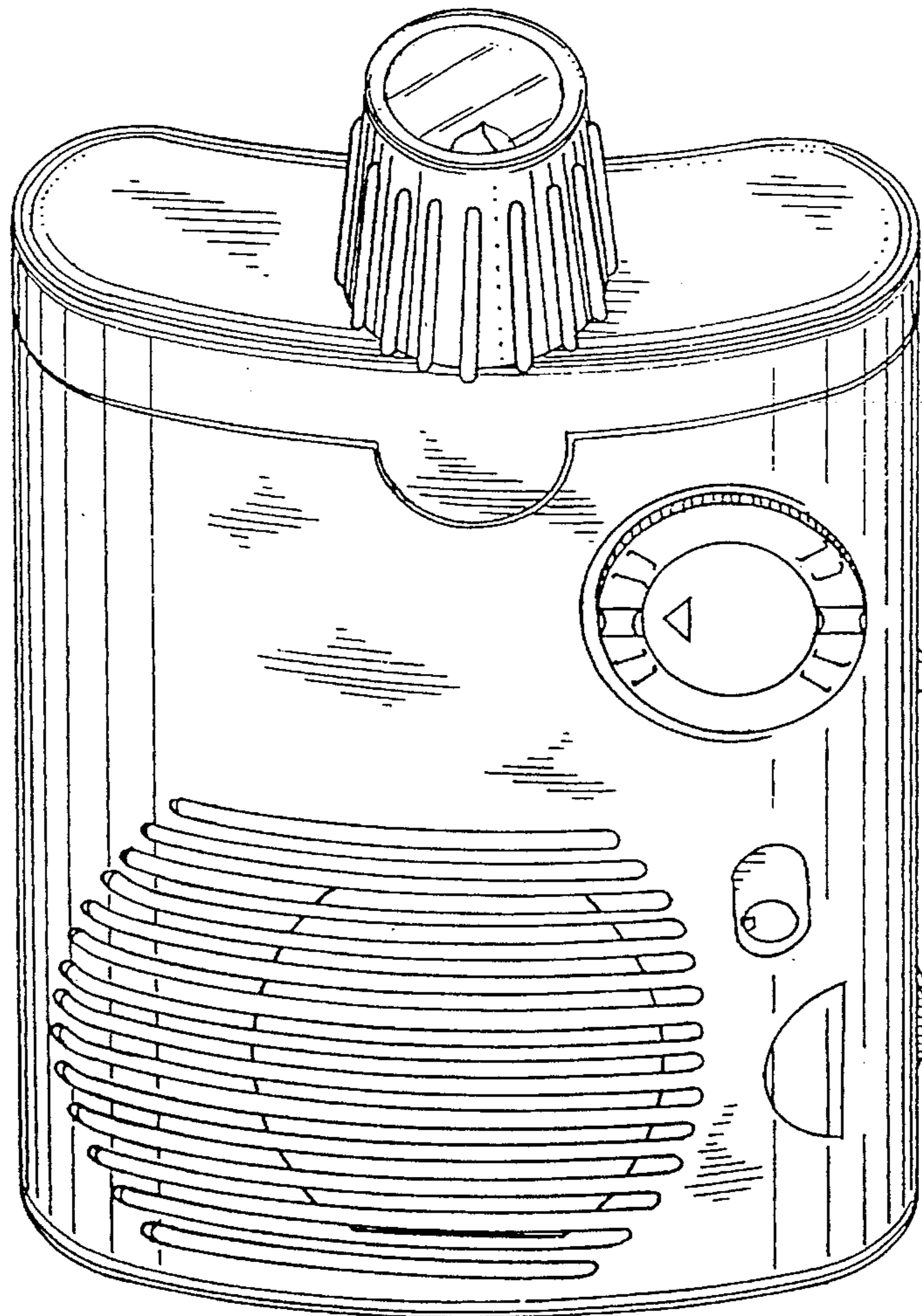

FIG. 1

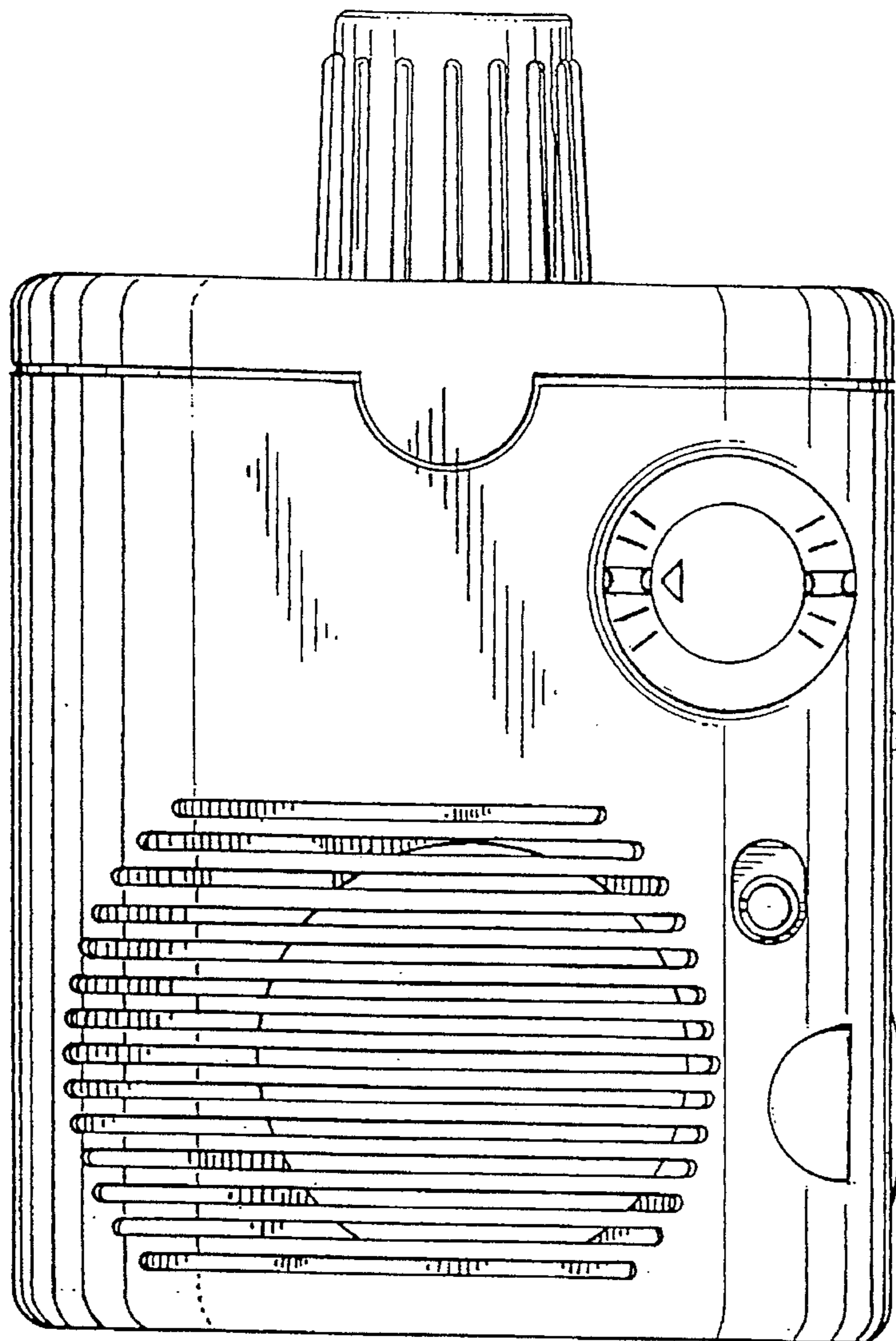

FIG. 3

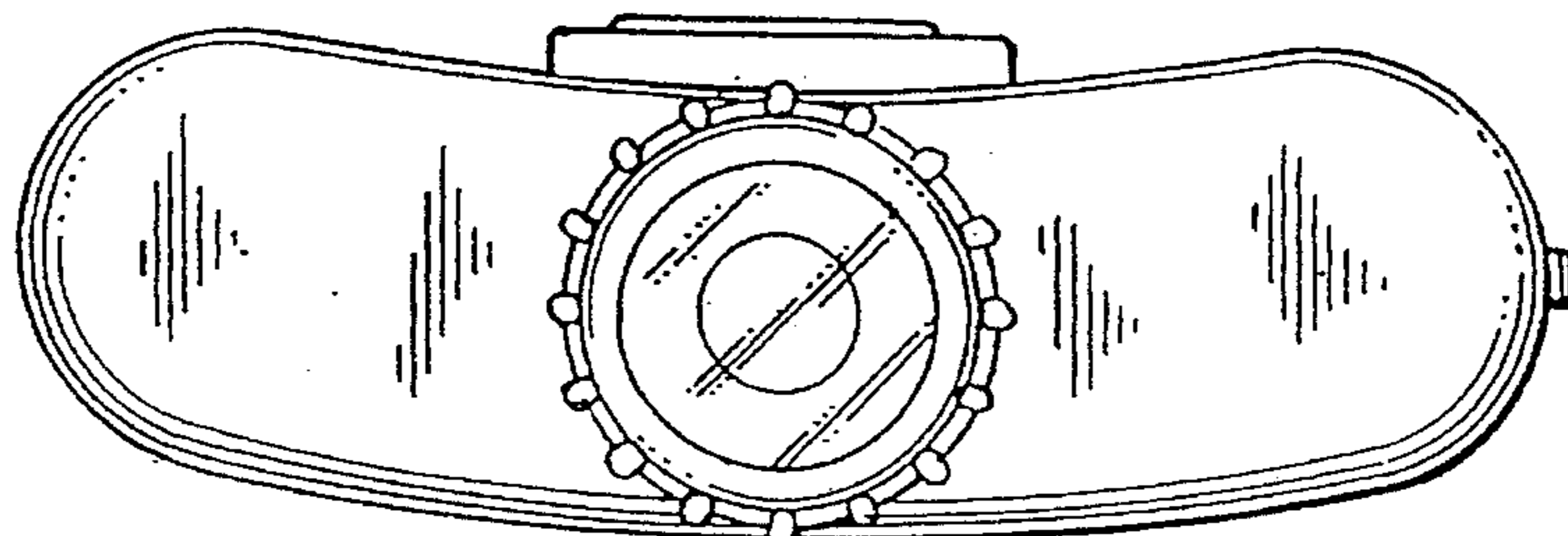

FIG. 2

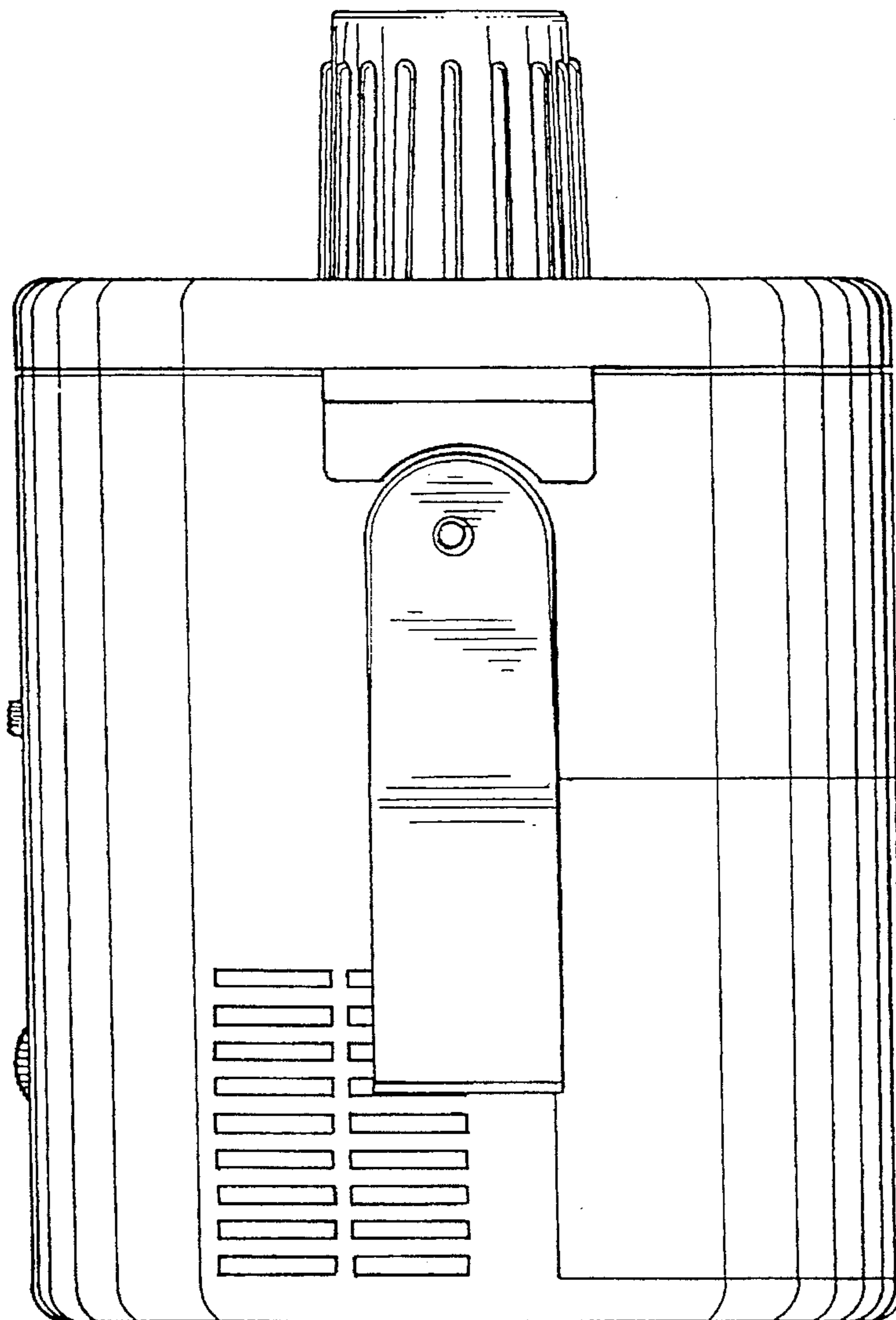

FIG. 4

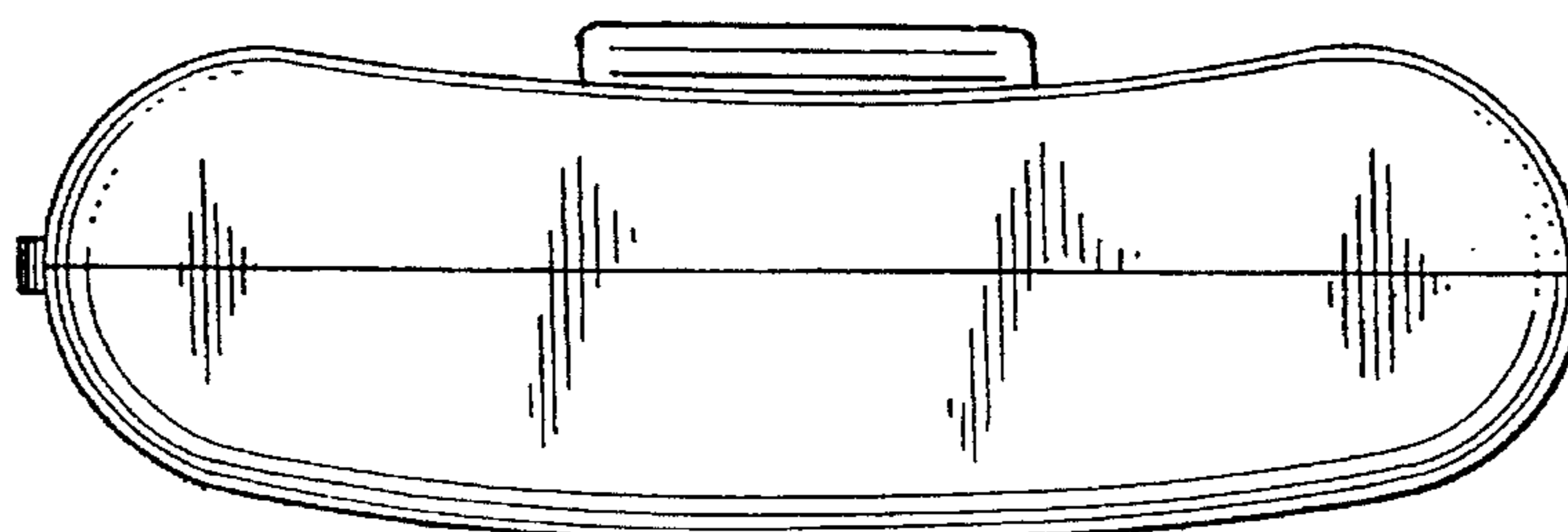

FIG. 5

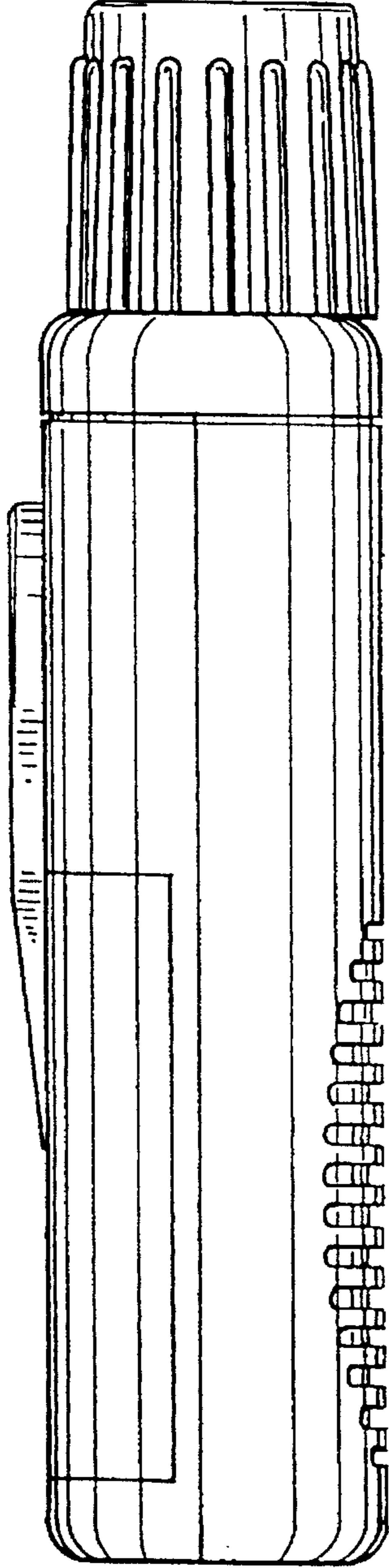

FIG. 6

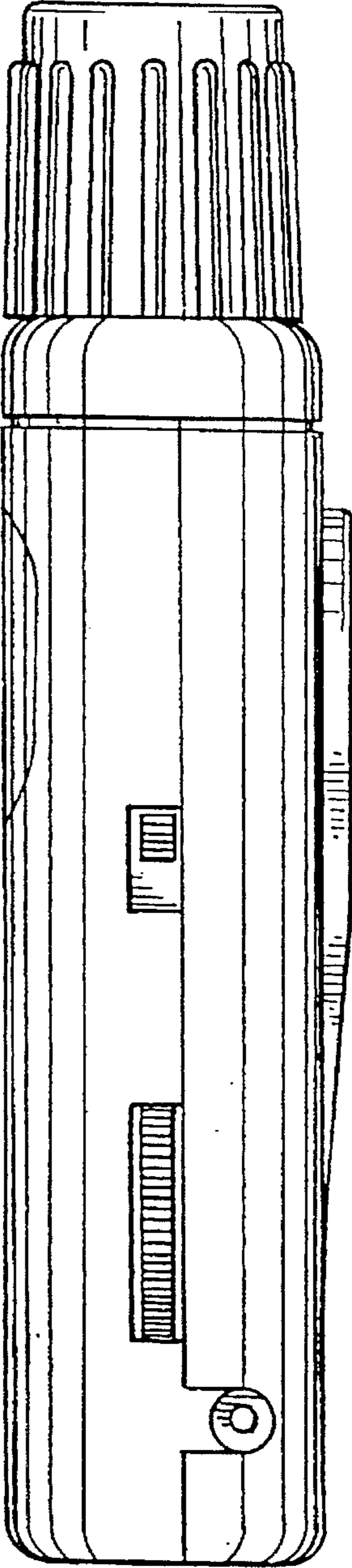

FIG. 7

