



US00D373161S

United States Patent [19]

[11] Patent Number: Des. 373,161

Schmidt et al.

[45] Date of Patent: **Aug. 27, 1996

[54] GOLF PUTTER HEAD WITH FACE PLATE INSERT

3,387,844	6/1968	Shippee .	
3,749,408	7/1973	Mills	273/171
3,815,910	6/1974	Raines .	
3,847,399	11/1974	Raymont .	

[76] Inventors: Glenn H. Schmidt, 1409 Schueren Rd., Malibu, Calif. 90265; Richard C. Helmstetter, 2285 Rutherford Rd., Carlsbad, Calif. 92008-8815

(List continued on next page.)

FOREIGN PATENT DOCUMENTS

[**] Term: 14 Years

371974 5/1932 United Kingdom .

OTHER PUBLICATIONS

[21] Appl. No.: 30,464

[22] Filed: Oct. 31, 1994

Spalding 1989 Pro Golf Catalog; p. 25; TPM Gold (TPM I) Lower Left Corner of Page.

"Some of Our Best Friends are Hookers and Pushers", Golf World, Jan. 1974 p. 45.

"The Ounce That Counts", Golf World, Jan. 24, 1975, pp. 46 & 47.

"Stroke-Savers", Golf Digest, mar. 1988, pp. 82 and 83.

"the Wilson Staff Dynapower Iron", Time Magazine, Mar. 24, 1967, p. 1.

"FTD Iron by First Flight", Golf World, May 23, 1972, p. 10.

"T.P. super Blade", Golf World, Jun. 13, 1972, p. 25.

Related U.S. Application Data

[63] Continuation-in-part of Ser. No. 24,688, Jun. 20, 1994, which is a continuation-in-part of Ser. No. 16,187, Dec. 9, 1993.

[52] U.S. Cl. D21/219

[58] Field of Search D21/217-219; 273/167-175

Primary Examiner—Terry A. Wallace

Assistant Examiner—Mitchell T. Siegel

Attorney, Agent, or Firm—William W. Haefliger

[56] References Cited

U.S. PATENT DOCUMENTS

- D. 162,054 2/1951 Markovich .
- D. 223,767 6/1972 Houghtaling .
- D. 228,355 9/1973 Penna .
- D. 238,285 12/1975 Ross .
- D. 245,441 8/1977 Middlestadt .
- D. 246,541 11/1977 Myers .
- D. 248,783 8/1978 Long .
- D. 257,784 1/1981 Forys et al. .
- D. 320,427 10/1991 Antonious .
- D. 321,738 11/1991 Brown D21/219
- D. 321,920 11/1991 Parente et al. .
- D. 328,936 8/1992 Antonious .
- D. 334,606 4/1993 Cameron .
- 922,444 5/1909 Youds .
- 1,511,479 10/1924 Kelly et al. .
- 1,517,476 12/1924 Tyler .
- 1,854,548 4/1932 Hunt .
- 2,231,847 2/1941 Dickson et al. .
- 3,134,596 5/1964 Boznos .
- 3,199,872 8/1965 Taylor .
- 3,211,455 10/1965 Hyden .
- 3,218,072 11/1965 Burr .
- 3,333,854 8/1967 White .

[57] CLAIM

The ornamental design for golf putter head with face plate insert, as shown and described.

DESCRIPTION

FIG. 1 is a front face view of a putter head embodying our new design;

FIG. 2 is a top plan view thereof;

Fig. 3 is a top end view thereof;

FIG. 4 is a heel end view thereof;

FIG. 5 is a bottom plan view thereof;

FIG. 6 is a rear view thereof;

FIG. 7 is a sectional view taken on lines 7—7 of FIG. 6; and, FIG. 8 is a sectional view taken on lines 8—8 of FIG. 6.

The broken line showing of a fragmented shaft is for illustrative purposes only and forms no part of the claimed design.

1 Claim, 3 Drawing Sheets

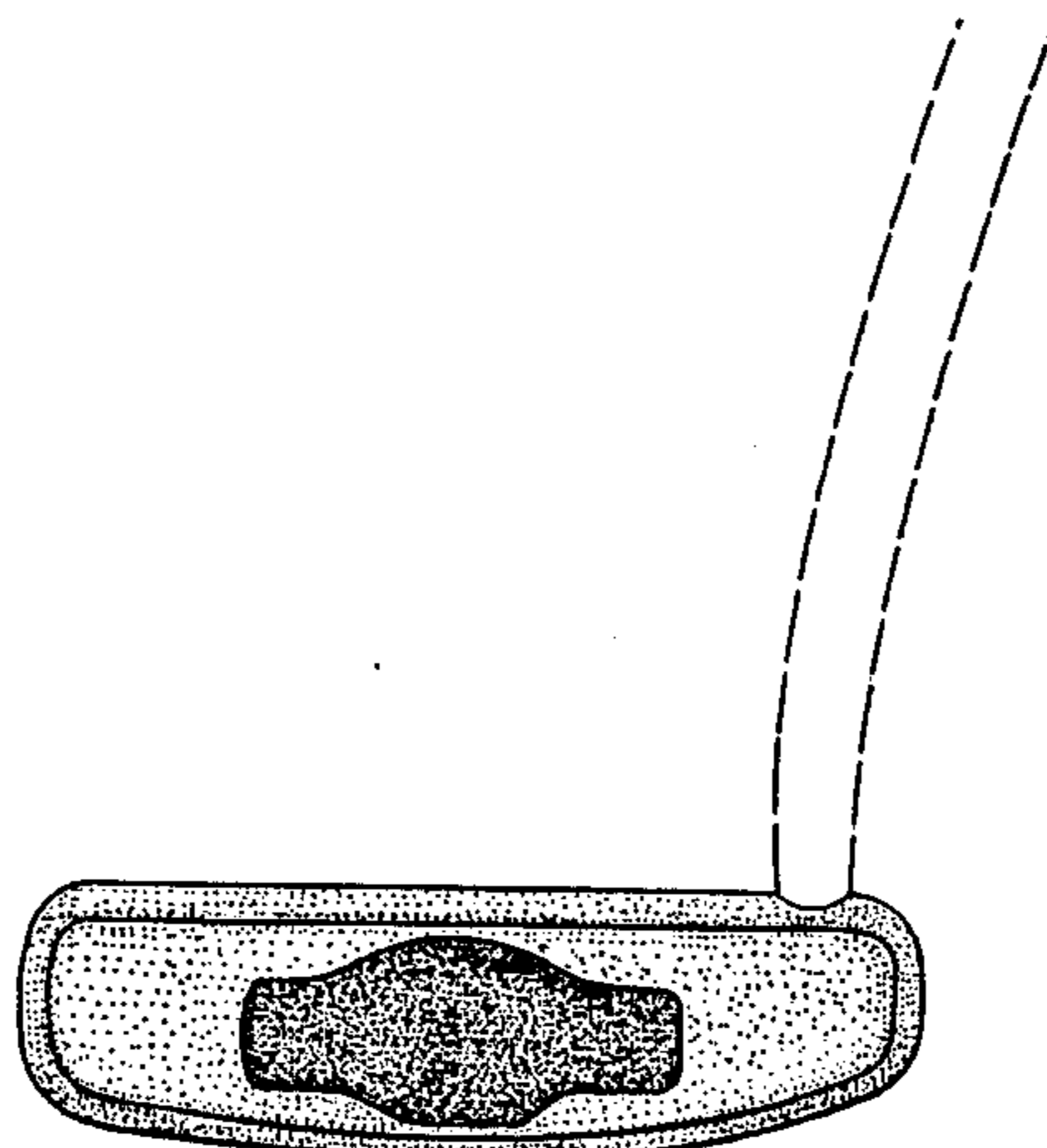

U.S. PATENT DOCUMENTS					
4,121,832	10/1978	Ebbing .	4,995,609	2/1991	Parente et al. .
4,330,128	5/1982	Morelli .	5,016,882	5/1991	Fujimura et al. .
4,398,965	8/1983	Campau .	5,067,711	11/1991	Parente et al. .
4,420,156	12/1983	Campau .	5,078,398	1/1992	Reed et al. .
4,484,746	11/1984	Brill .	5,083,778	1/1992	Douglass .
4,582,321	4/1986	Yoneyama .	5,110,131	5/1992	Long .
4,655,459	4/1987	Antonious .	5,154,423	10/1992	Antonious .
4,679,792	7/1987	Straza et al. .	5,154,425	10/1992	Niskanen et al. .
4,740,345	4/1988	Nagasaki et al. .	5,176,384	1/1993	Sata et al. .
4,848,747	7/1989	Fujimura et al. .	5,193,805	3/1993	Solheim .
4,869,507	9/1989	Sahm .	5,197,737	3/1993	Desbiolles et al. .
4,884,812	12/1989	Nagasaki et al. .	5,222,734	6/1993	Parente et al. .
4,913,435	4/1990	Kobayashi .	5,242,167	9/1993	Antonious .
4,928,972	5/1990	Nakanishi et al. .	5,246,231	9/1993	Antonious .
4,960,279	10/1990	Harris, Jr. .	5,248,145	9/1993	Brown .
4,964,640	10/1990	Nakanishi et al. .	5,301,946	4/1994	Schmidt et al. .
			5,340,107	9/1994	Baker et al. .

FIG. 1.

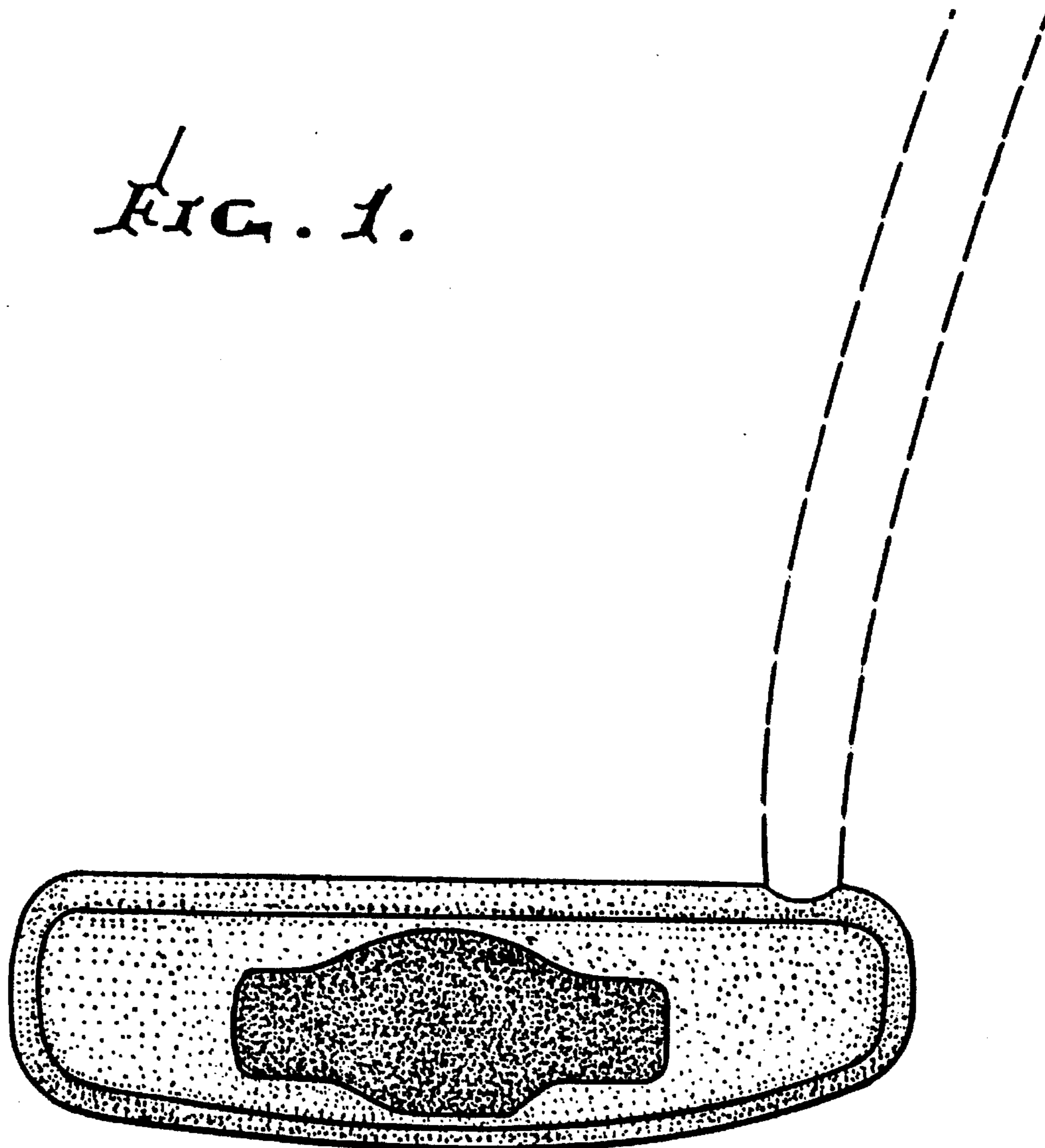

FIG. 2.

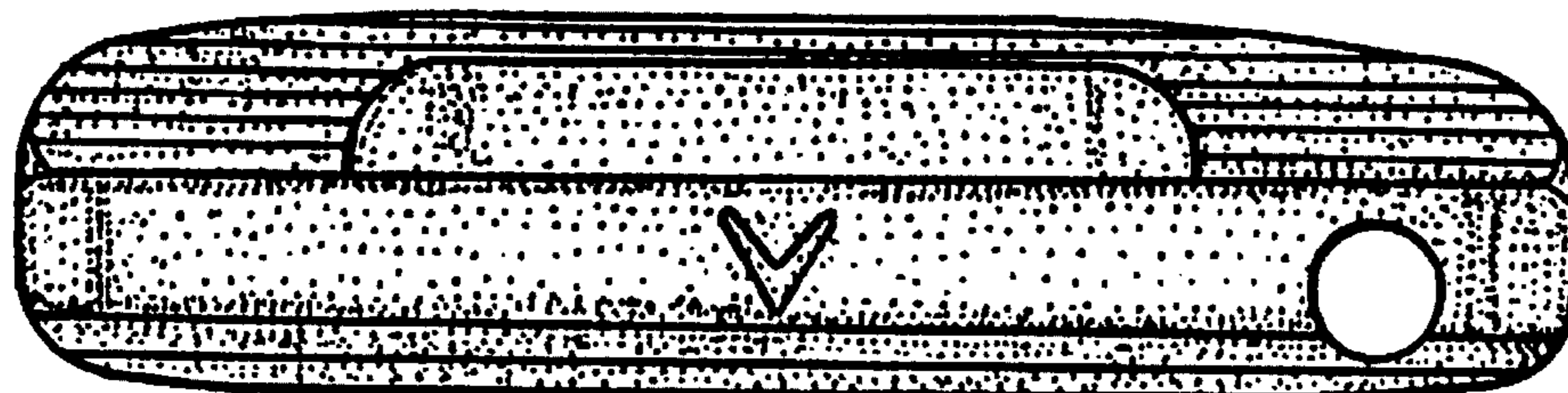



FIG. 3.



FIG. 4.

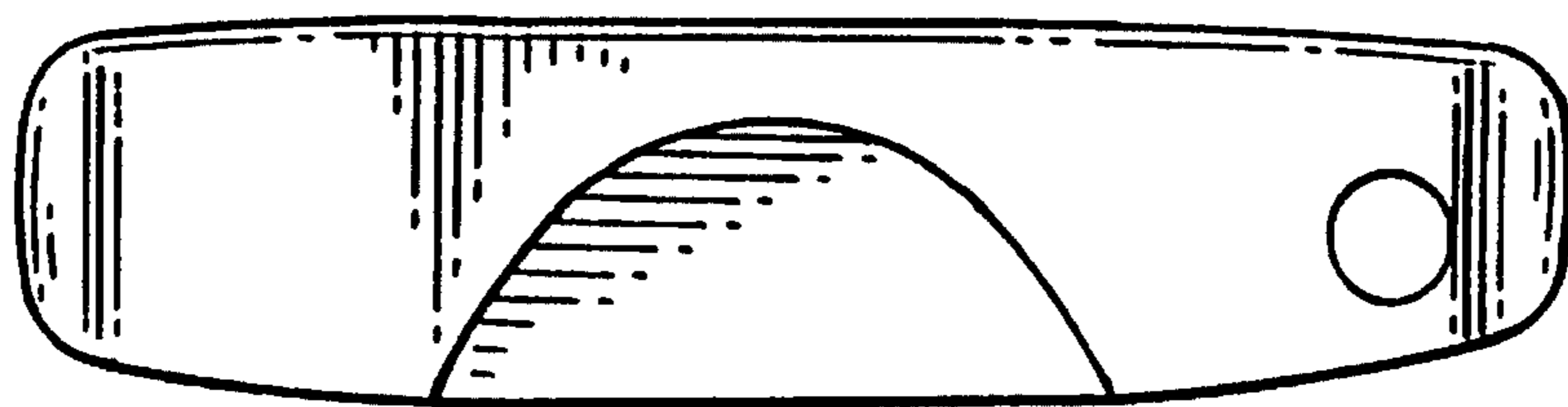

FIG. 5.

FIG. 7.

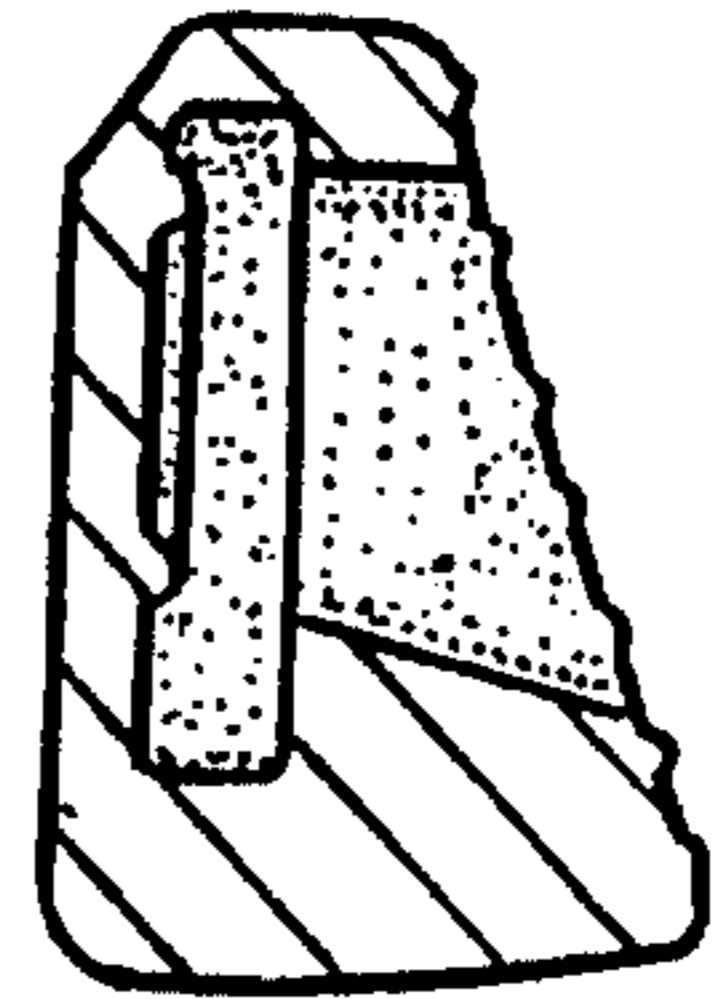

FIG. 6.

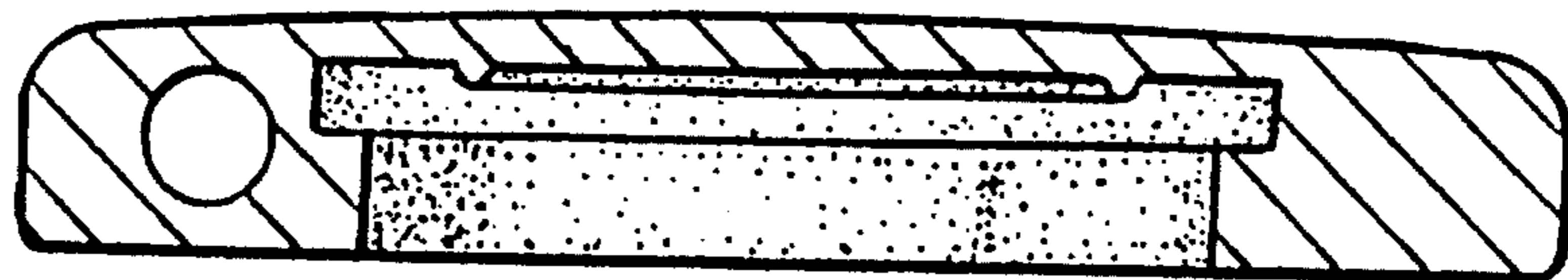
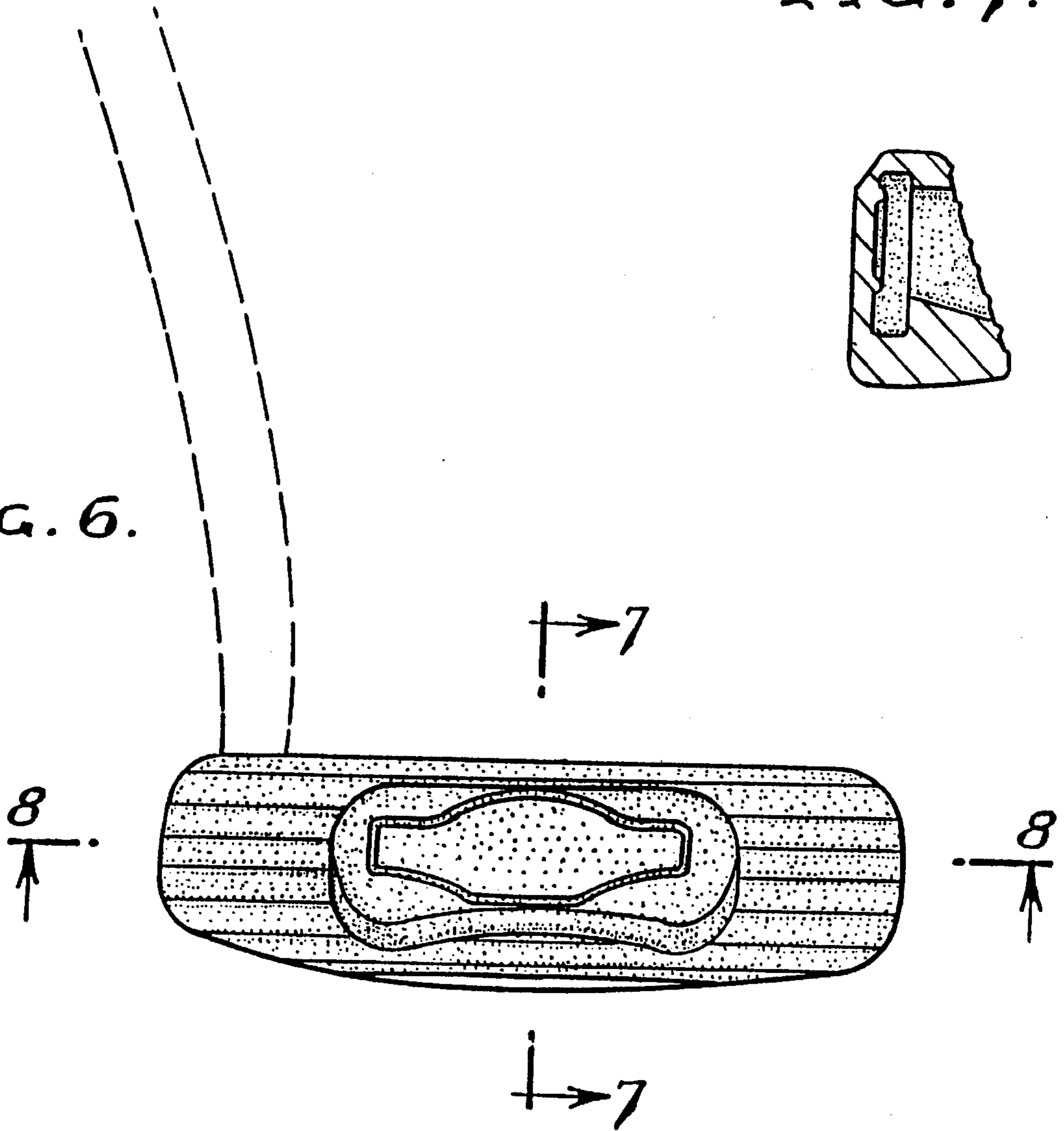

FIG. 8.