



US00D373144S

United States Patent [19]
Hansen

[11] **Patent Number: Des. 373,144**

[45] **Date of Patent: **Aug. 27, 1996**

[54] **MATHEMATIC TEACHING RACK**
[76] Inventor: **Alice M. Hansen**, 13162 Highway 8,
Space 80, El Cajon, Calif. 92021
[**] Term: **14 Years**
[21] Appl. No.: **23,997**
[22] Filed: **Jun. 6, 1994**
[52] **U.S. Cl.** **D19/62**
[58] **Field of Search** D19/59-64; D18/6;
434/359, 203; D6/522, 546, 410, 315, 319,
320, 411, 465; D32/58; 211/206

4,812,124 3/1989 Colodner et al. 434/203
4,884,973 12/1989 Pak .
5,205,747 4/1993 Tan .

Primary Examiner—Susan J. Lucas
Assistant Examiner—Pamela Burgess

[57] **CLAIM**

The ornamental design for the mathematic teaching rack, as shown and described.

DESCRIPTION

FIG. 1 is a front elevational view of the mathematic teaching rack showing my new design; FIG. 2 is a rear elevational view thereof; FIG. 3 is a left side elevational view thereof; FIG. 4 is a right side elevational view thereof; FIG. 5 is a top plan view thereof; FIG. 6 is a bottom plan view thereof; and, FIG. 7 is a front perspective view thereof. The broken lines shown in FIGS. 5 and 7 are for illustrative purposes only and form no part of the claimed design.

[56] **References Cited**

U.S. PATENT DOCUMENTS

D. 149,083	3/1948	Mooney	434/203	X
D. 169,562	5/1953	Rieck	D19/59	X
D. 184,042	12/1958	Dochterman et al.	D18/6	
D. 300,040	2/1989	Dermody	D19/594	
3,455,034	7/1969	Schott	.		
3,811,205	5/1974	Pitzler	434/203	
3,995,378	12/1976	Darnell	.		
4,233,757	11/1980	Narcise	.		

1 Claim, 4 Drawing Sheets

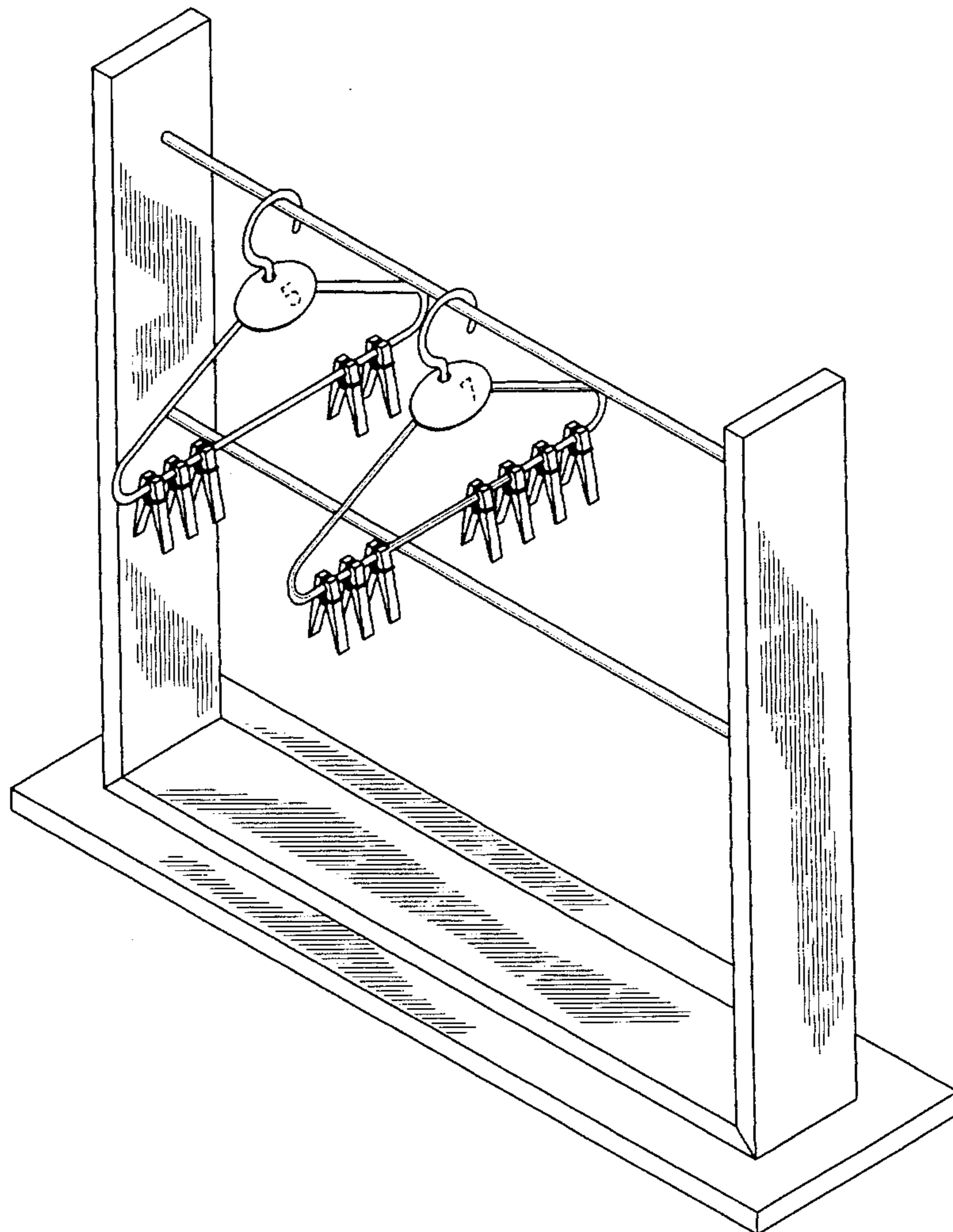

FIG. 1

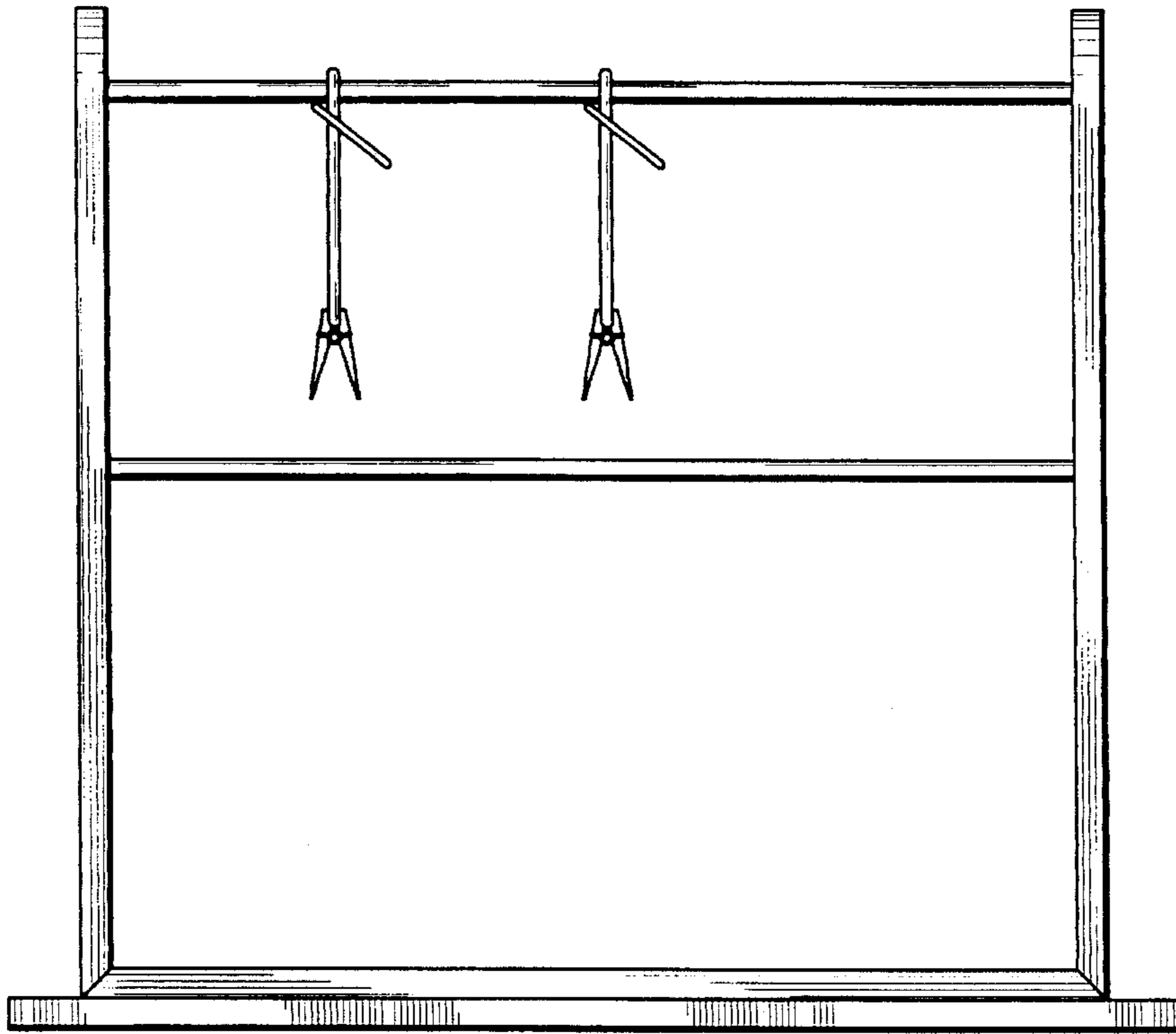

FIG. 2

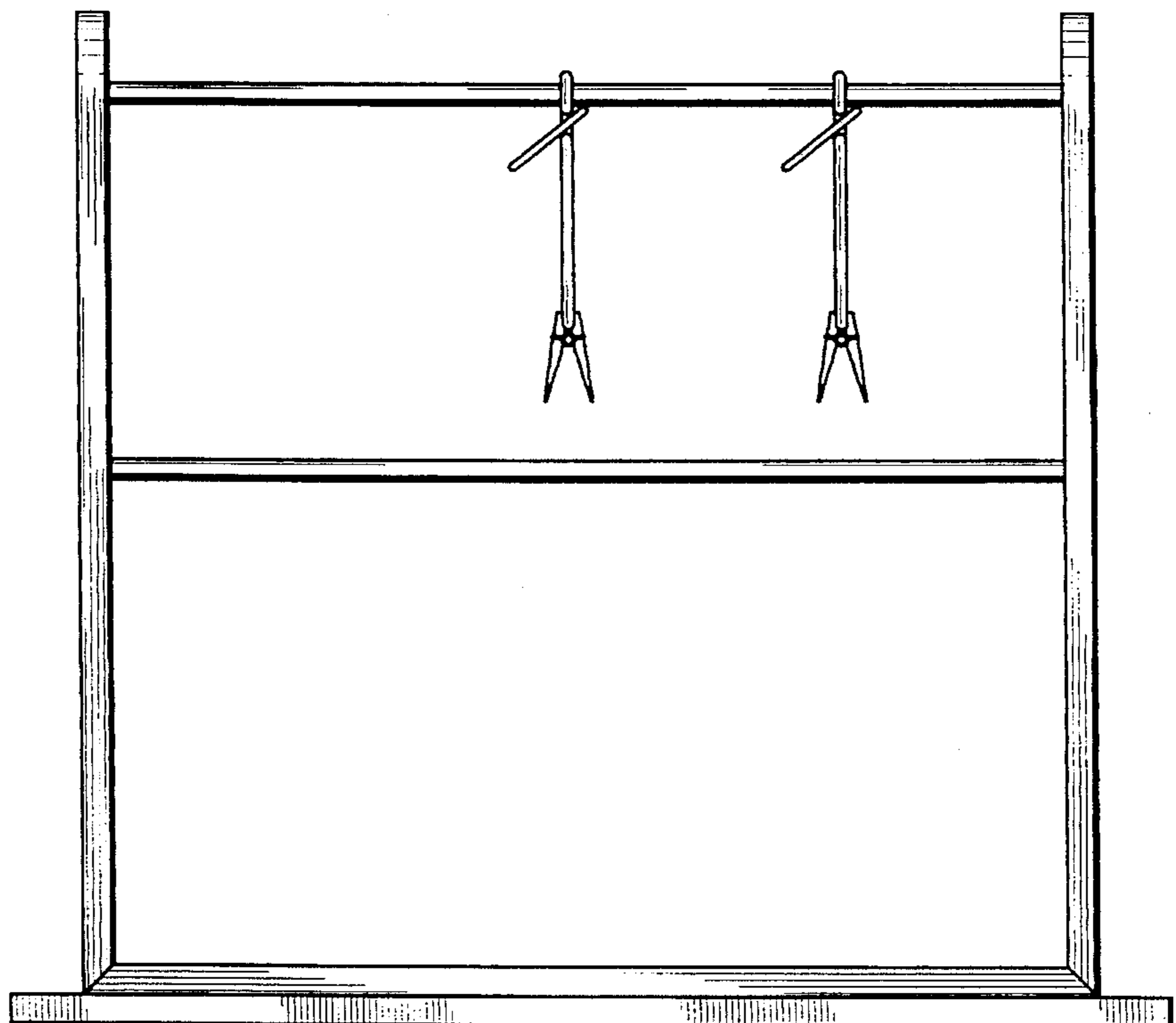

FIG. 3

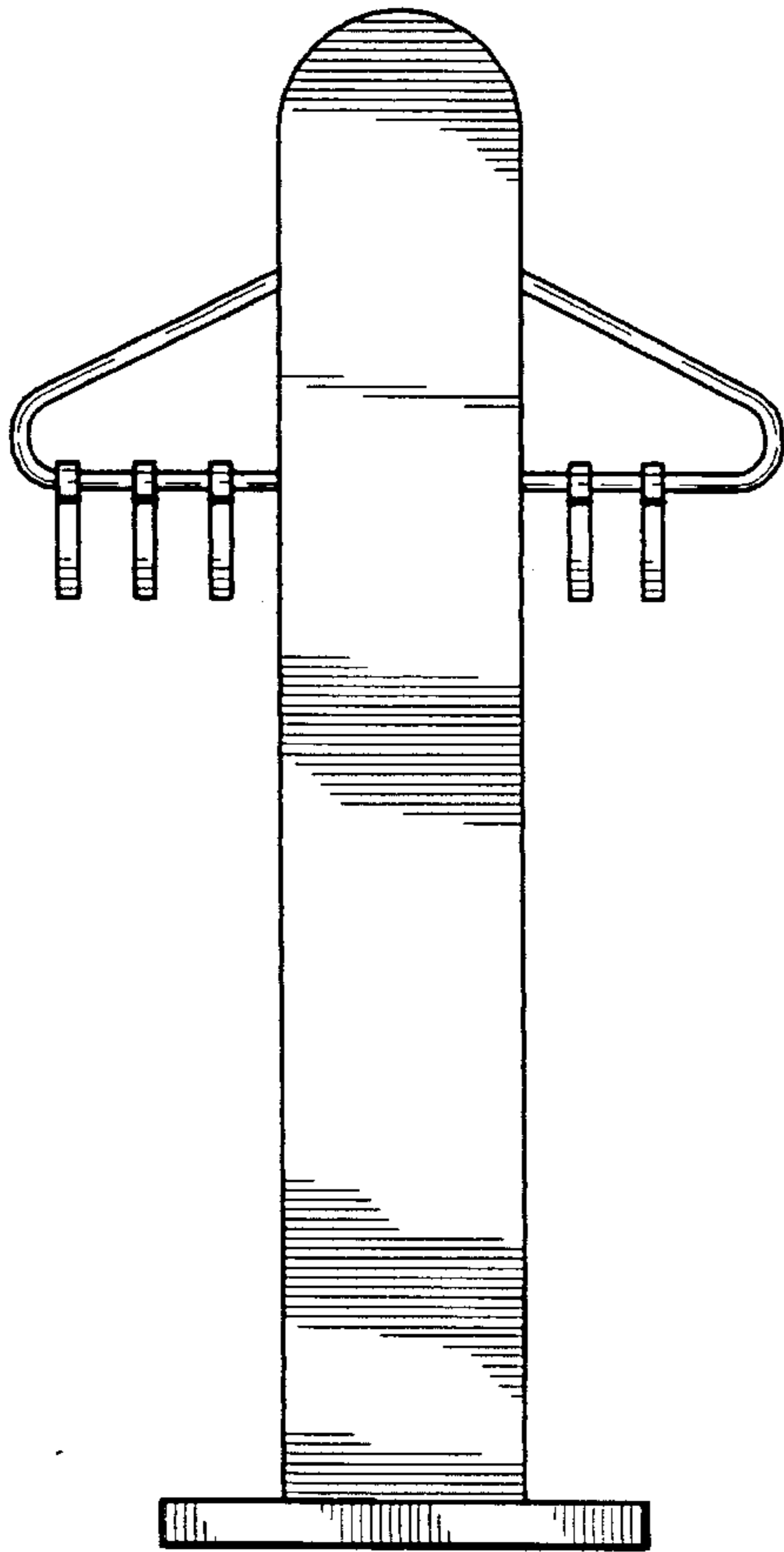

FIG. 4

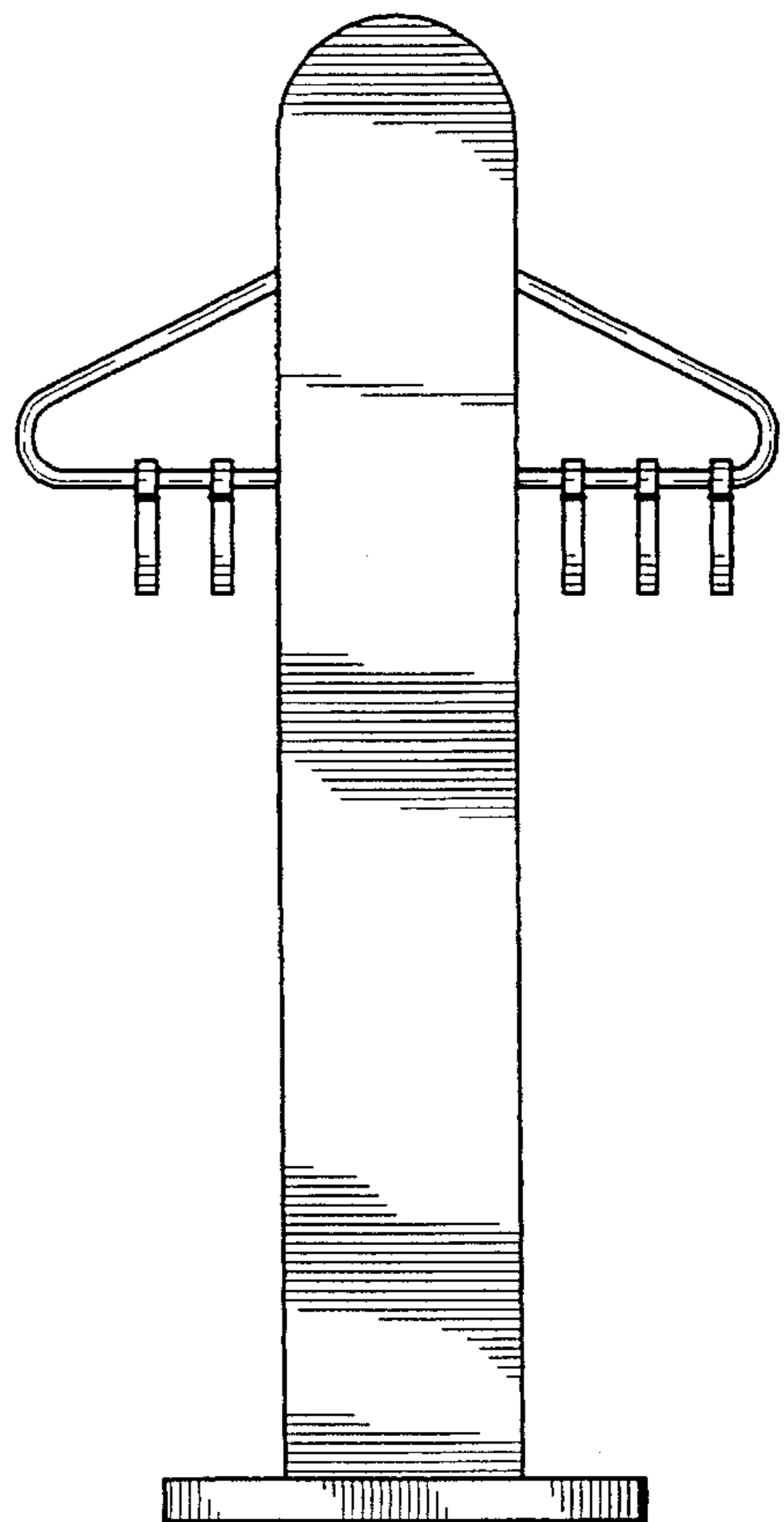

FIG. 5

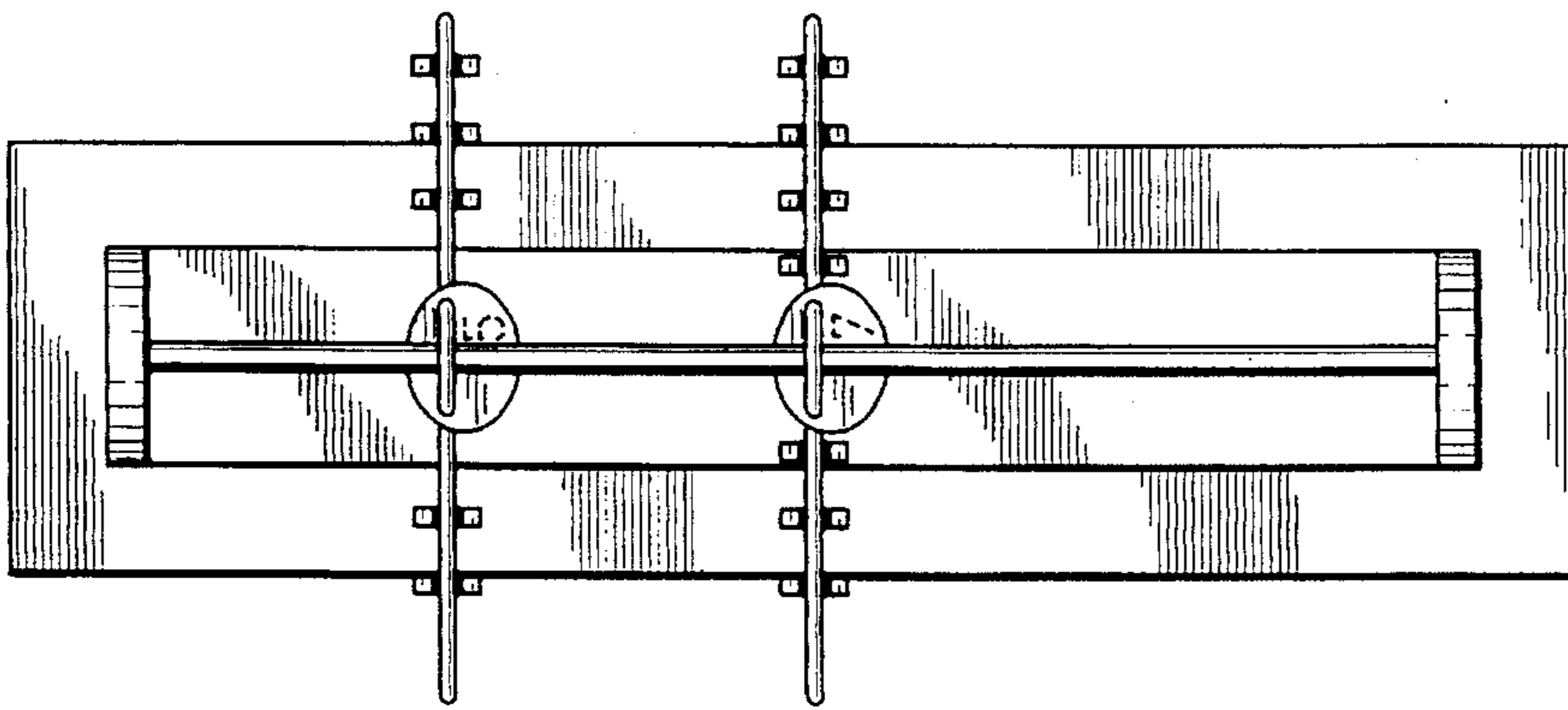

FIG. 6

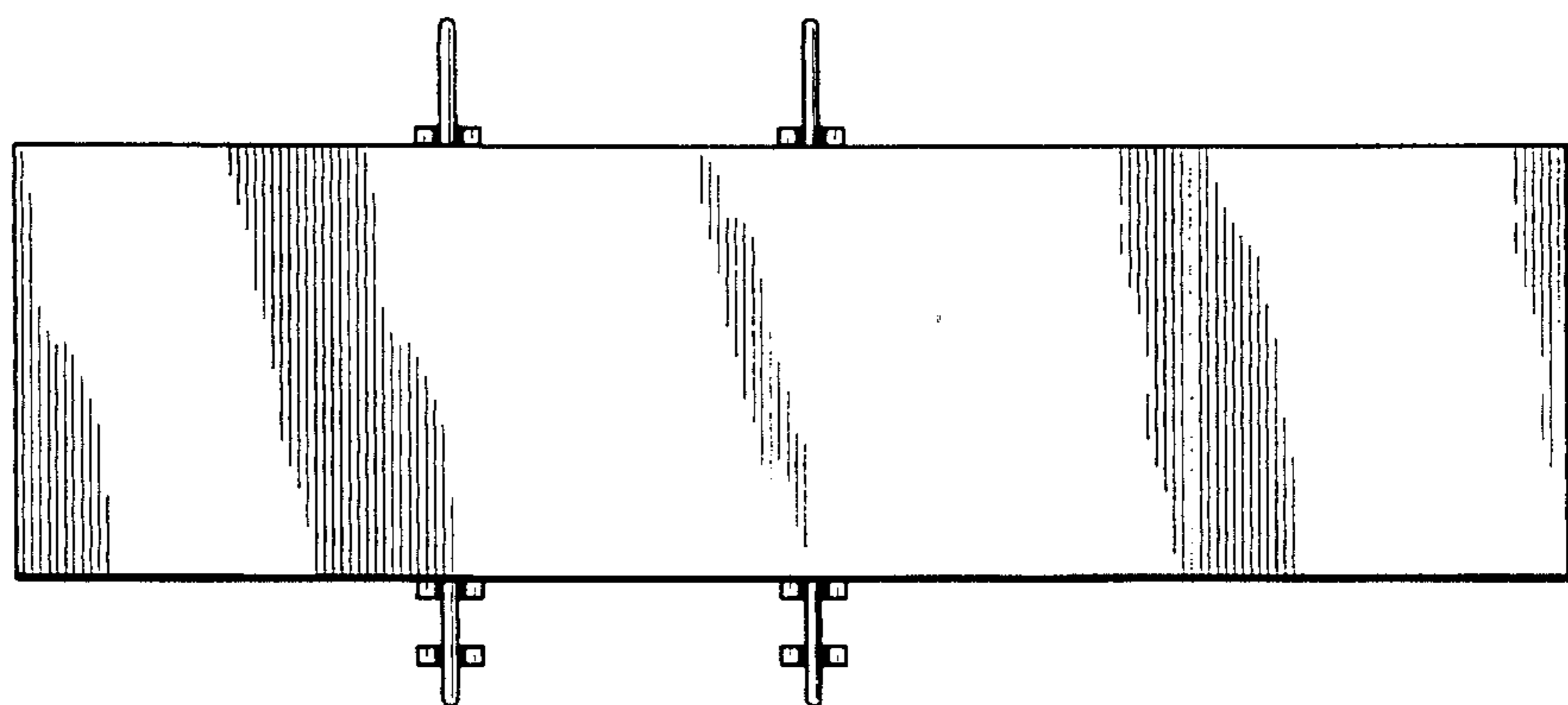

FIG. 7

