



US00D373057S

United States Patent [19] Chen

[11] Patent Number: **Des. 373,057**
[45] Date of Patent: ****Aug. 27, 1996**

[54] **ELECTRIC STAPLER**
[75] Inventor: **Benjamin M. J. Chen**, Taichung Hsien, Taiwan
[73] Assignee: **Regitar Power Tools Co., Ltd.**, Taichung Hsien, Taiwan
[**] Term: **14 Years**
[21] Appl. No.: **45,627**
[22] Filed: **Oct. 25, 1995**
[52] U.S. Cl. **D8/49; D8/69; 227/131**
[58] Field of Search **D8/49, 50, 61, D8/69; D19/72; 227/120, 127, 128, 130, 131-132, 134**

Attorney, Agent, or Firm—Morton J. Rosenberg; David I. Klein

[57] CLAIM

The ornamental design for an electric stapler, as shown and described.

DESCRIPTION

FIG. 1 is a perspective view of an electric stapler showing my new design;
FIG. 2 is a front side elevational view thereof;
FIG. 3 is a rear side elevational view thereof;
FIG. 4 is a left view thereof;
FIG. 5 is a right view thereof;
FIG. 6 is a top plan view thereof;
FIG. 7 is a bottom plan view thereof;
FIG. 8 is a perspective view of an electric stapler showing a second embodiment of my new design;
FIG. 9 is a front side elevational view thereof;
FIG. 10 is a rear side elevational view thereof;
FIG. 11 is a left view thereof;
FIG. 12 is a right view thereof;
FIG. 13 is a top plan view thereof; and,
FIG. 14 is a bottom plan view thereof.

[56] References Cited

U.S. PATENT DOCUMENTS

D. 241,501	9/1976	Doyle et al.	D8/49
D. 282,345	1/1986	Fehrs	D8/49
D. 350,681	9/1994	Juhlin et al.	D8/69
D. 365,974	1/1996	Matuscheck	D8/69
4,053,093	10/1977	Thueringer	227/130

Primary Examiner—Prabhakar G. Deshmukh
Assistant Examiner—Adir Aronovich

1 Claim, 10 Drawing Sheets

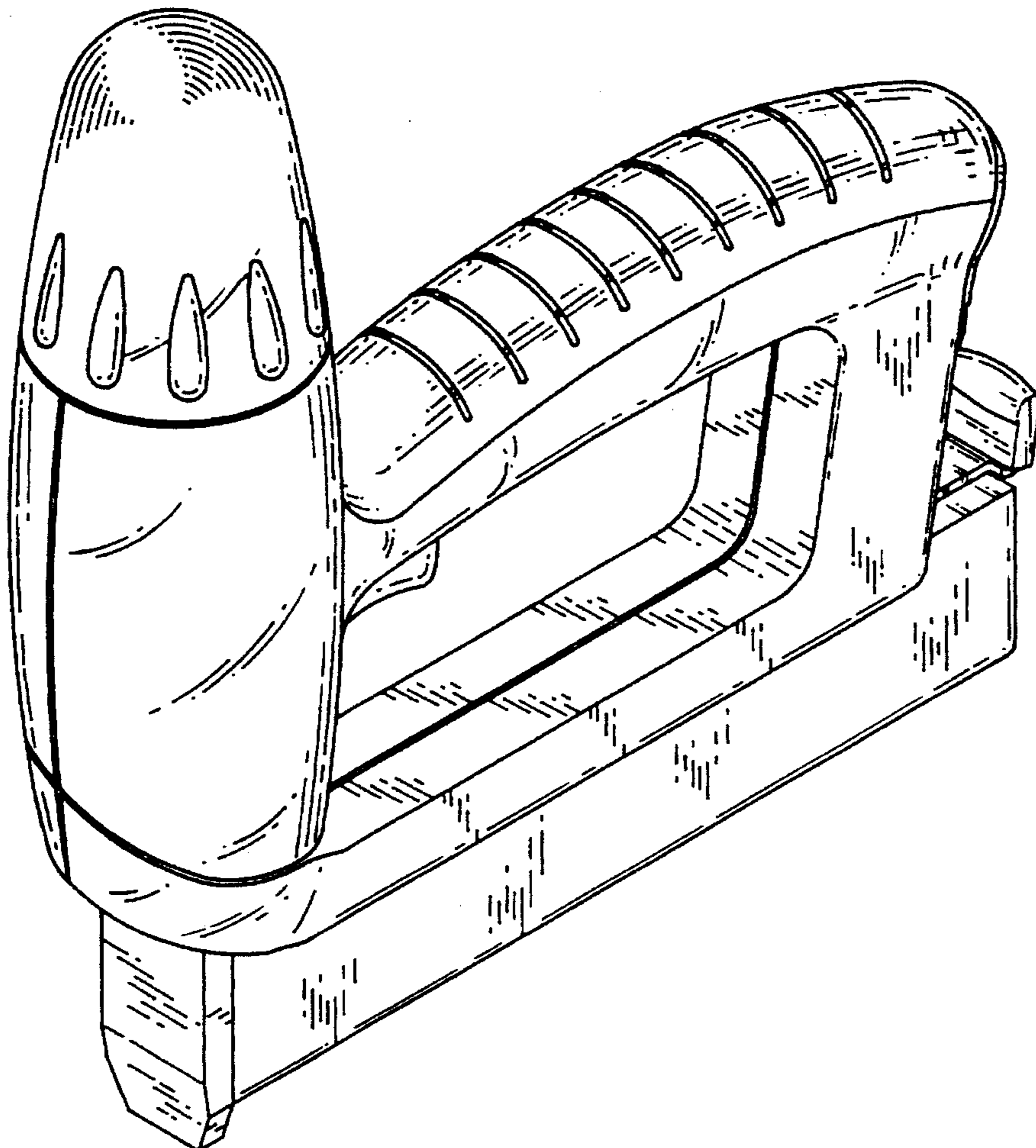

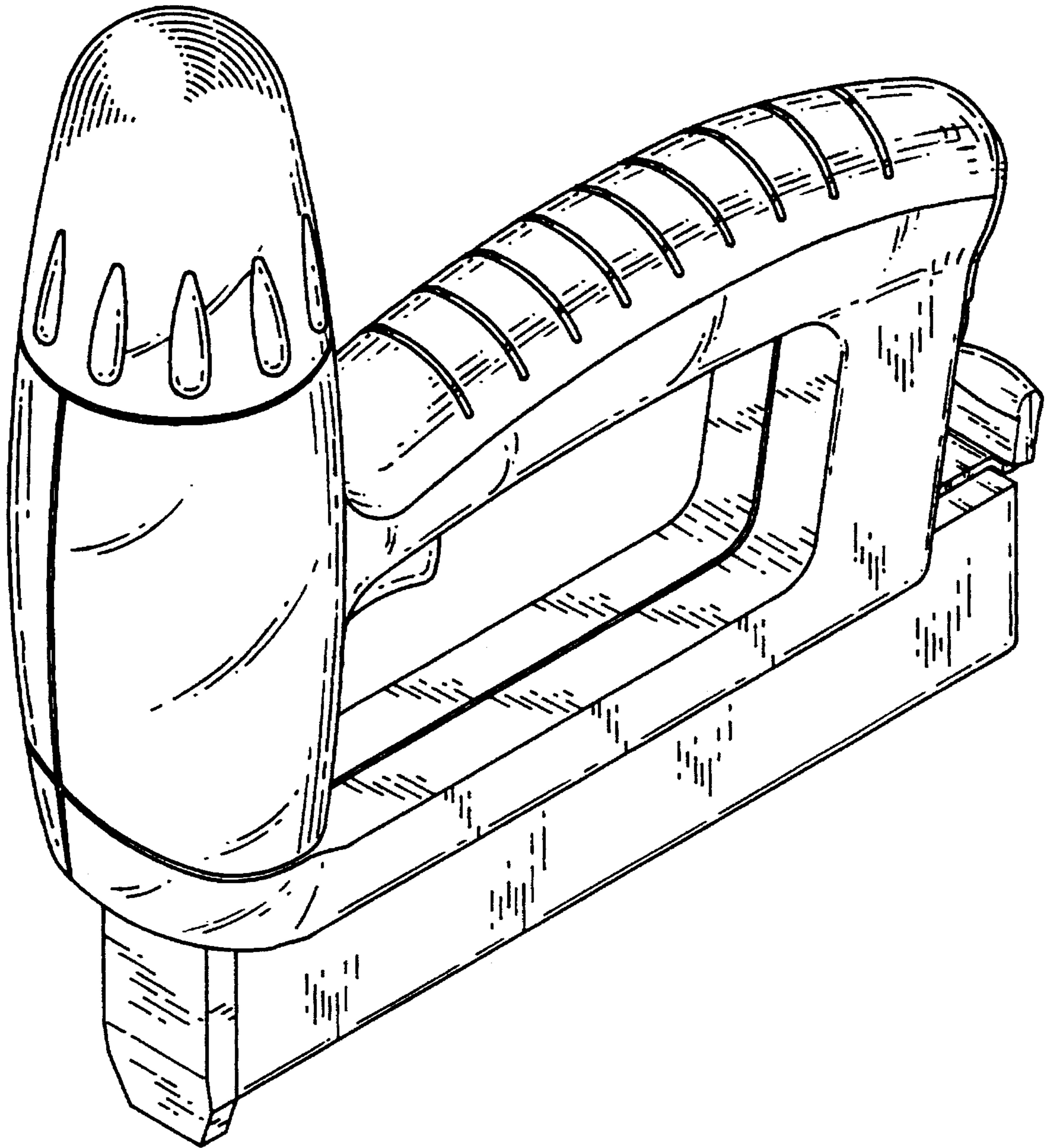

FIG. 1

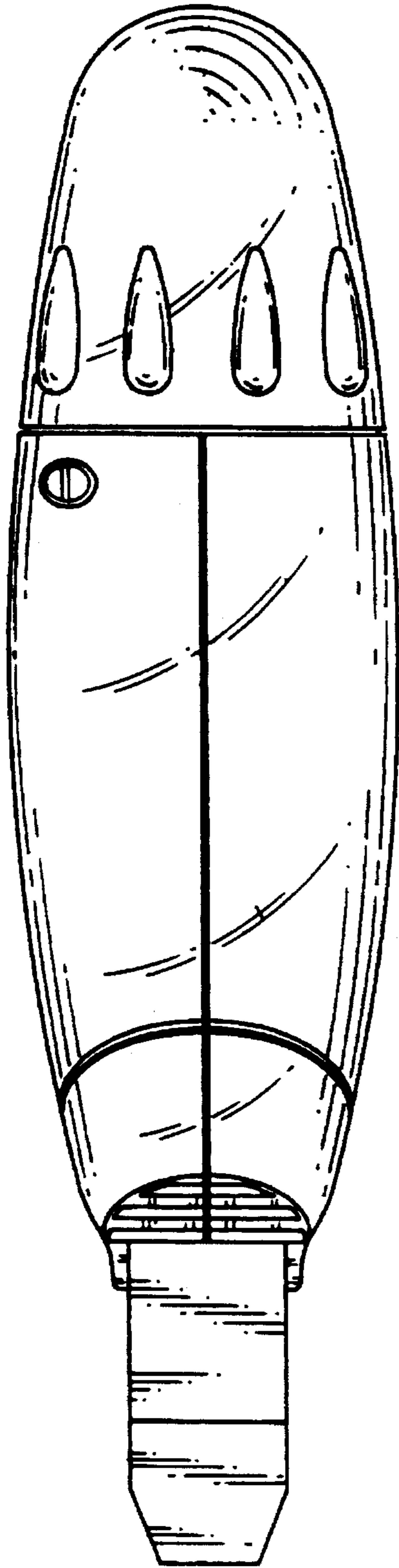

FIG. 2

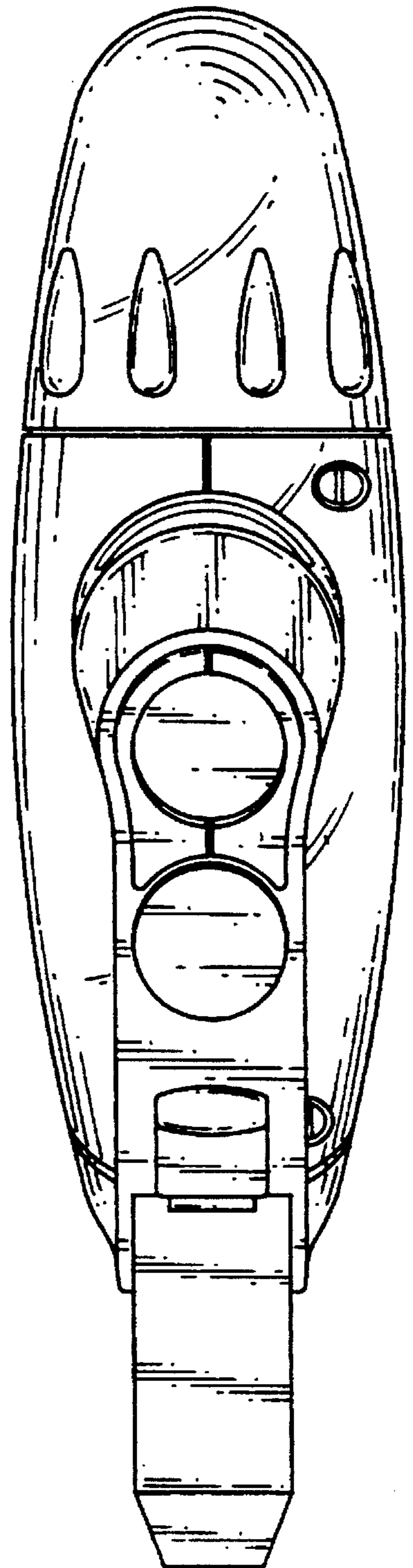

FIG. 3

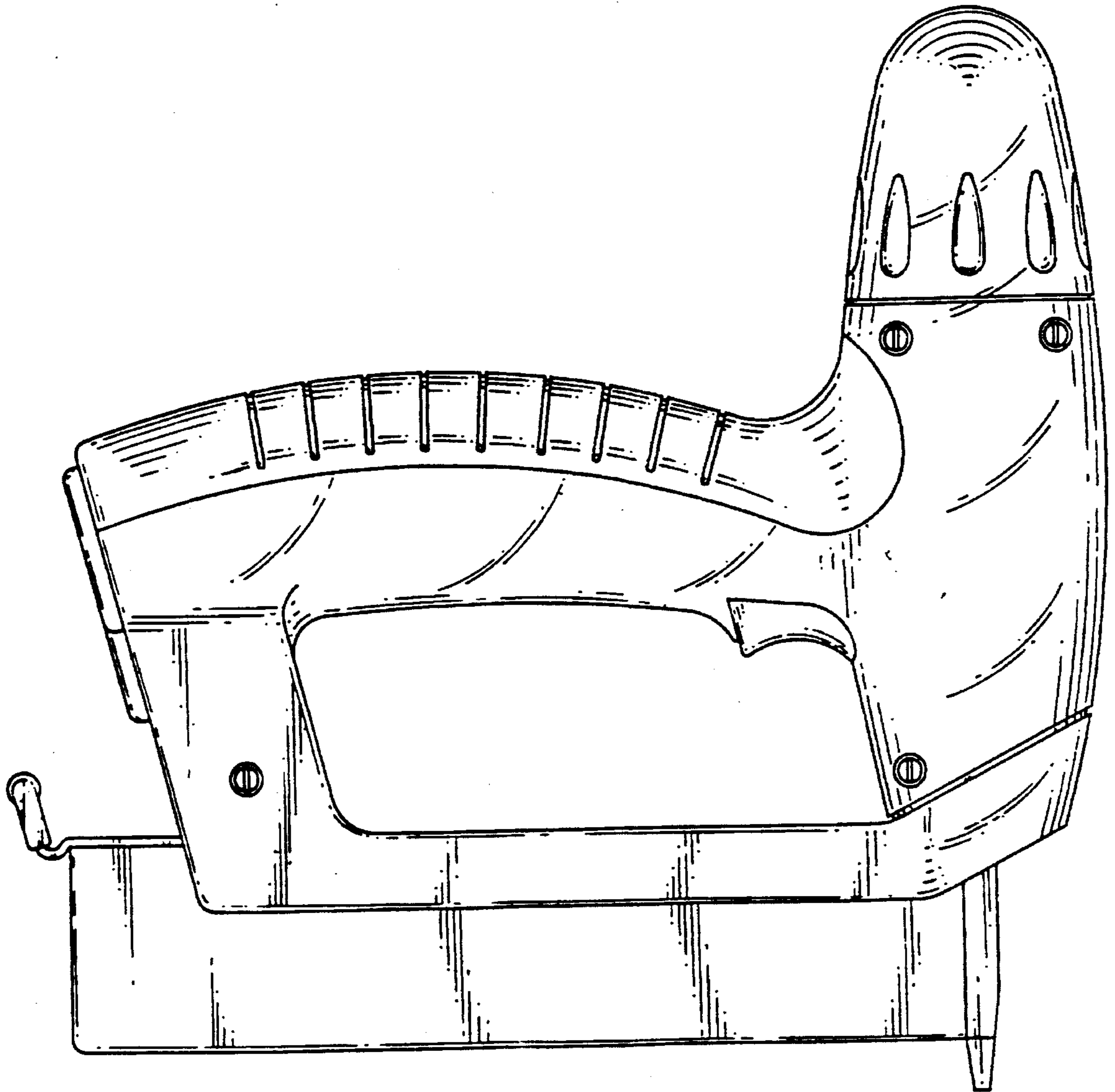

FIG. 4

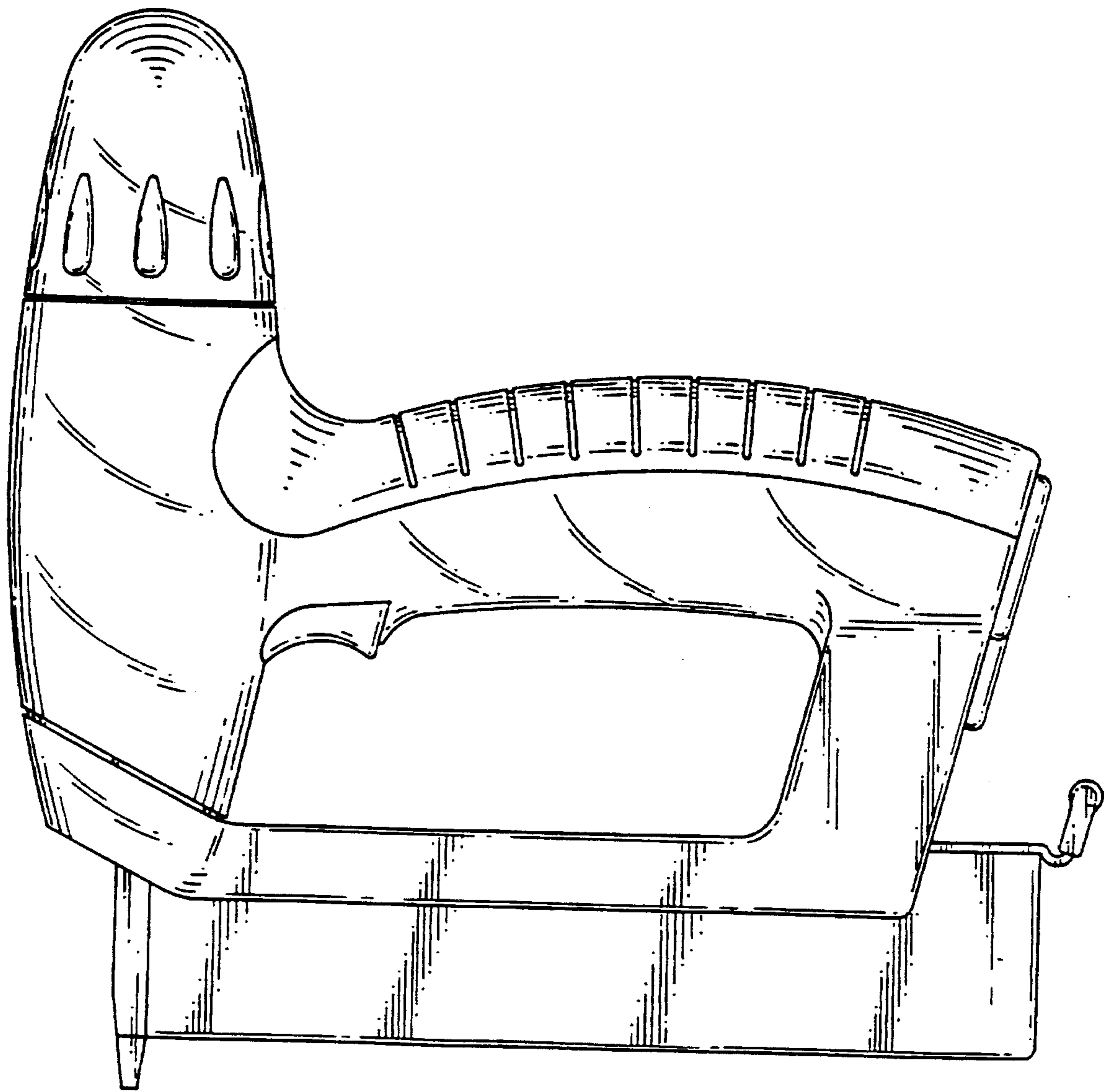

FIG. 5

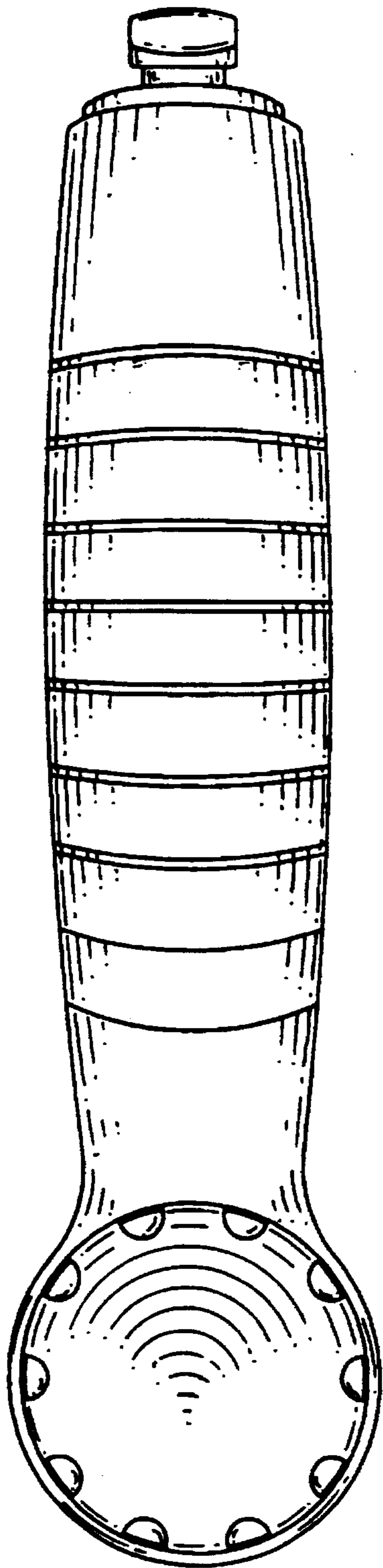

FIG. 6

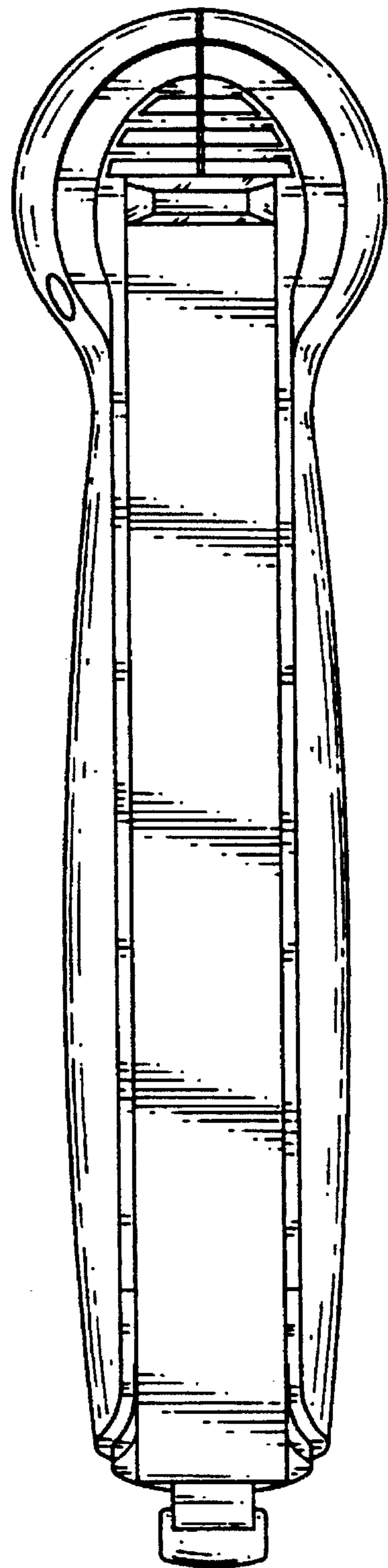

FIG. 7

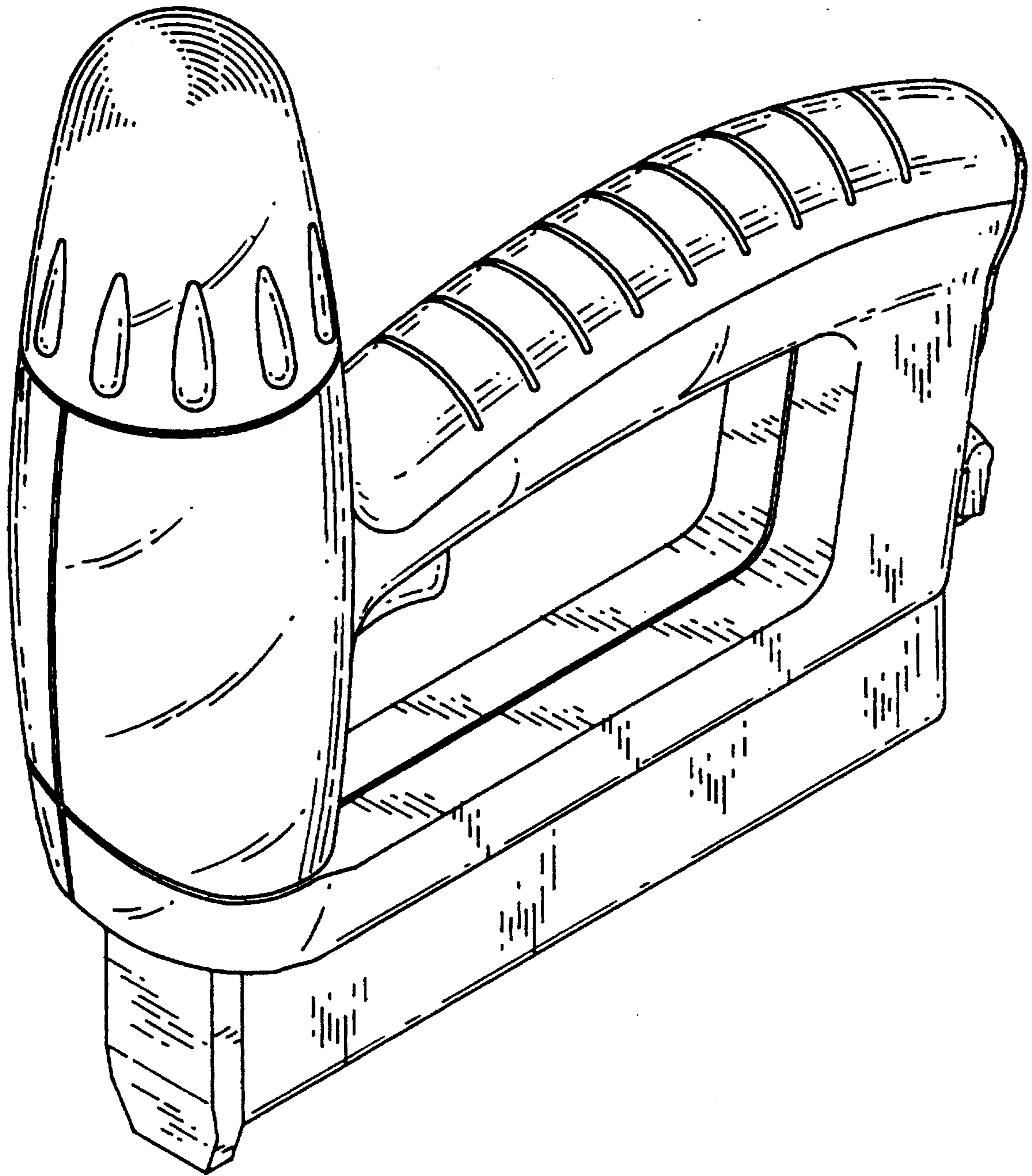

FIG. 8

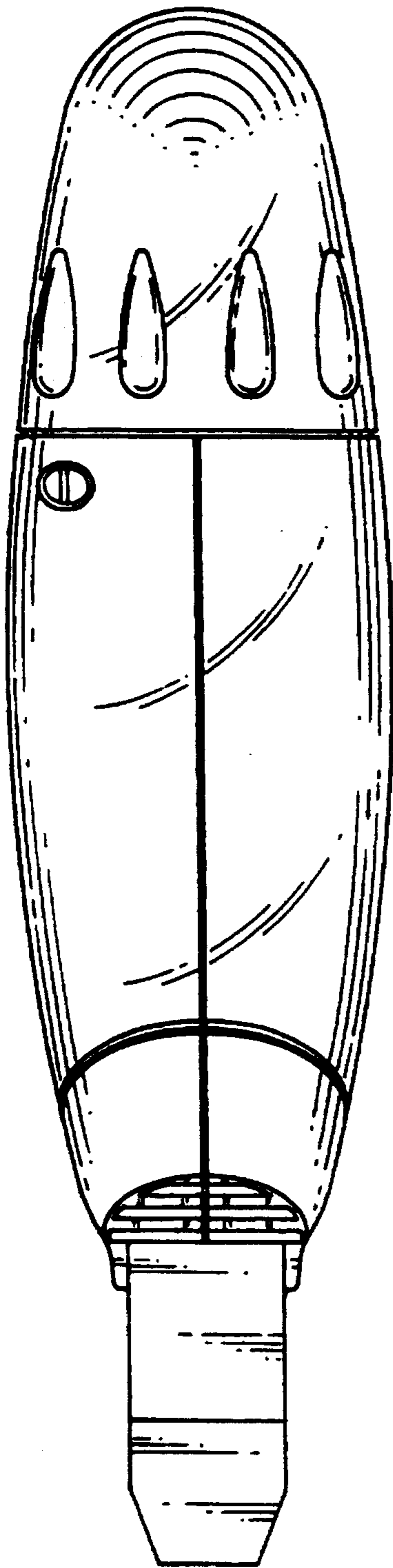

FIG. 9

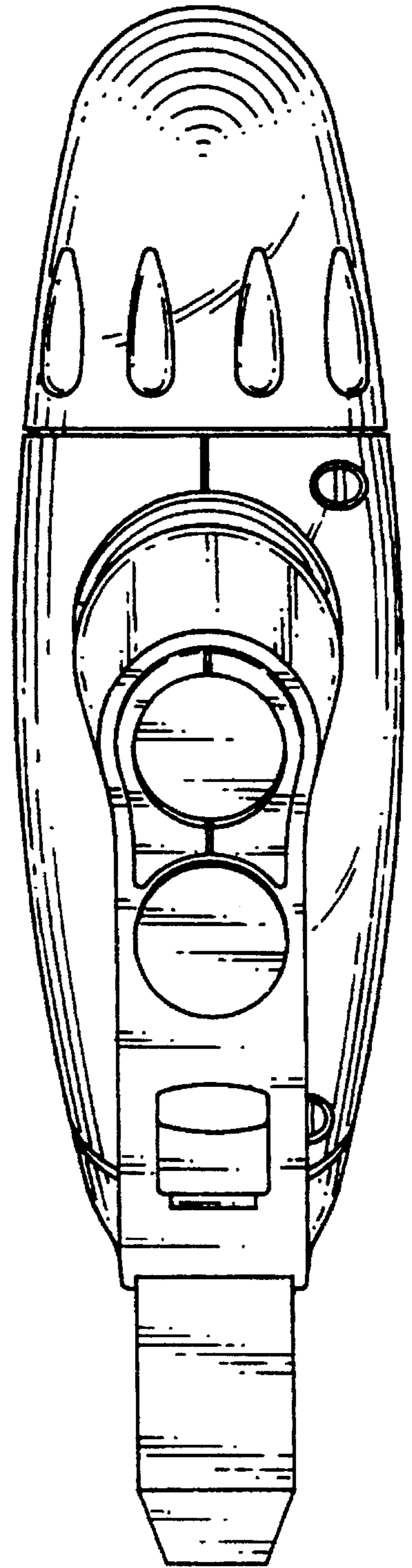

FIG. 10

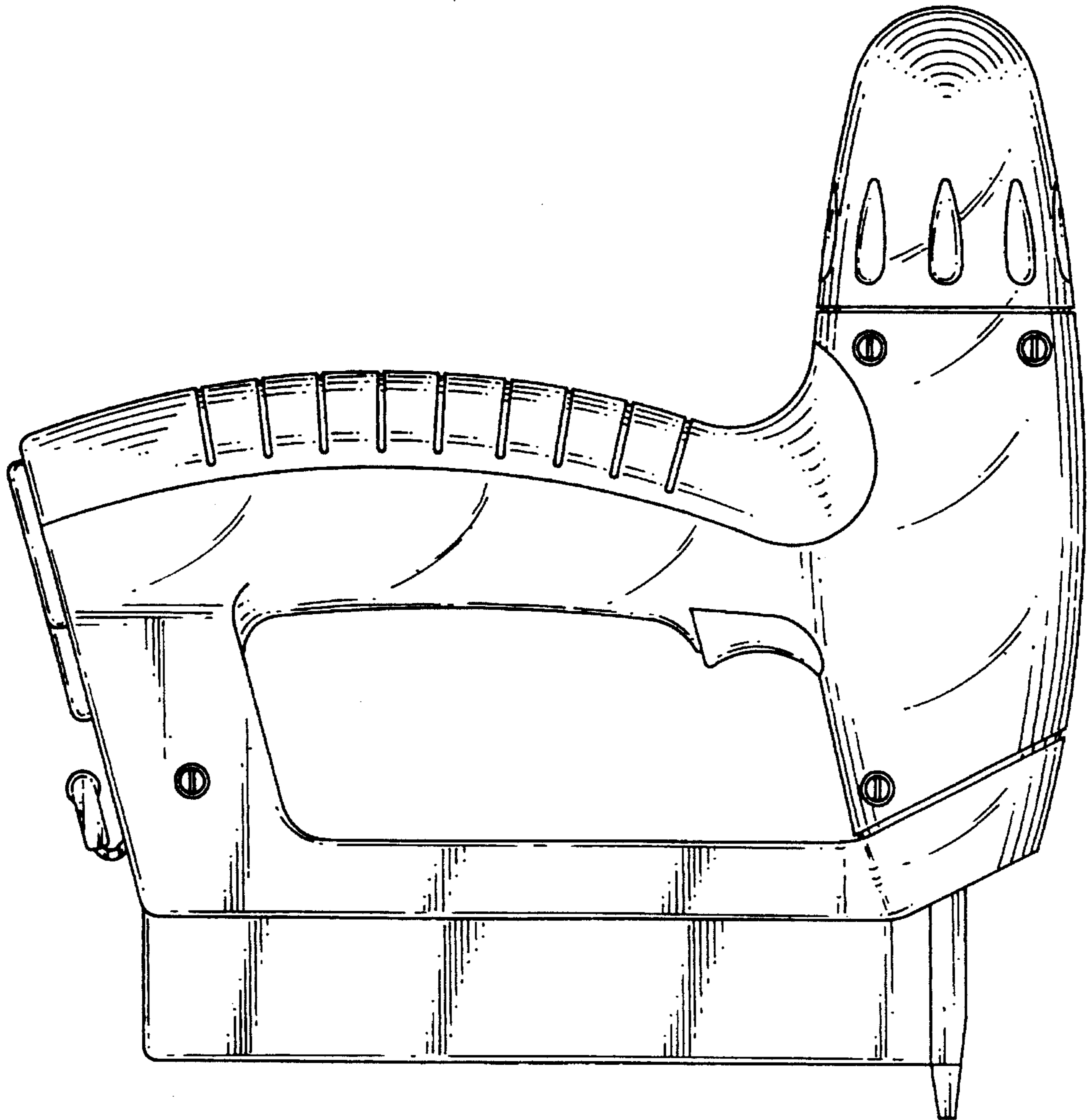

FIG. 11

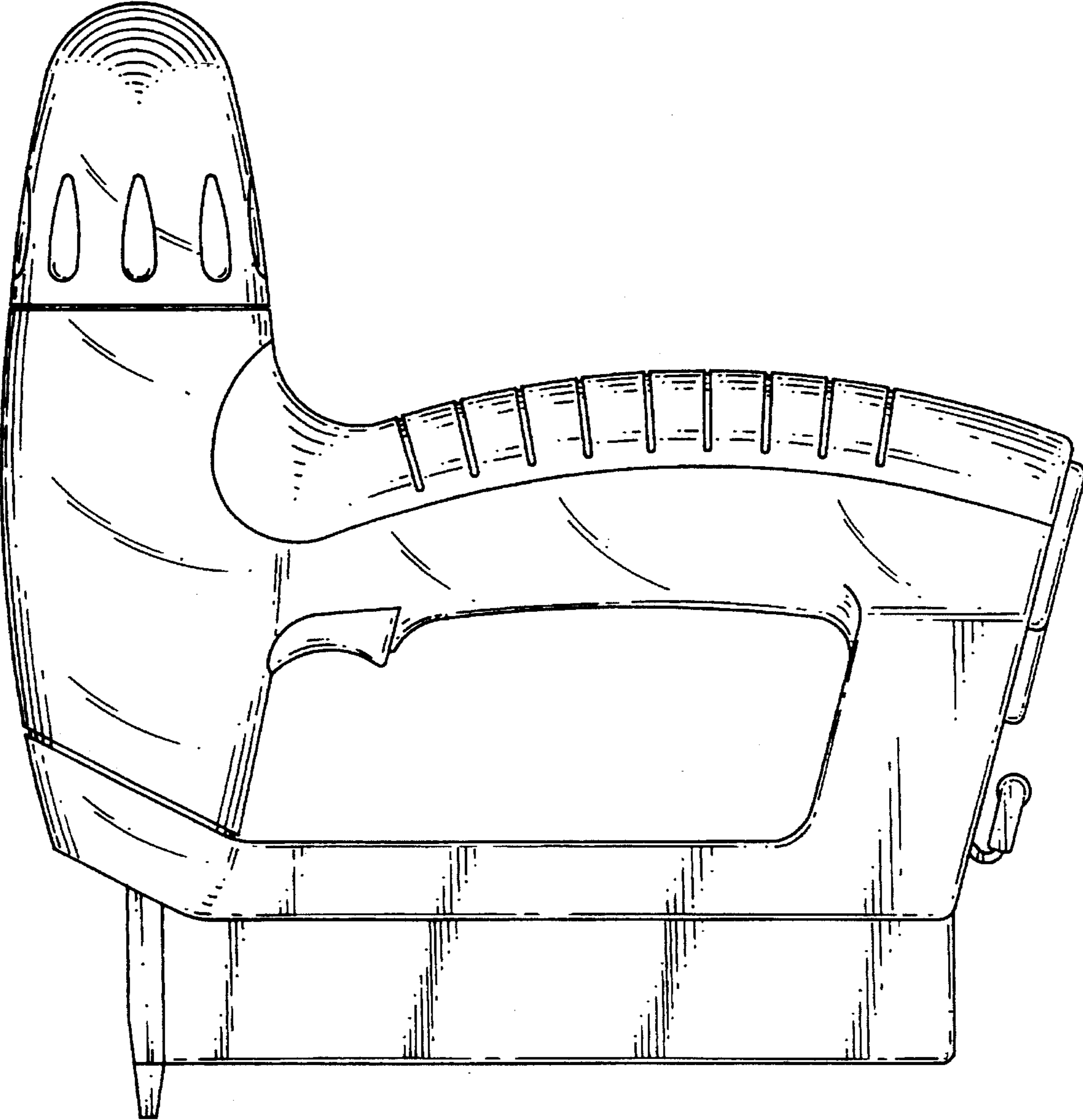

FIG. 12

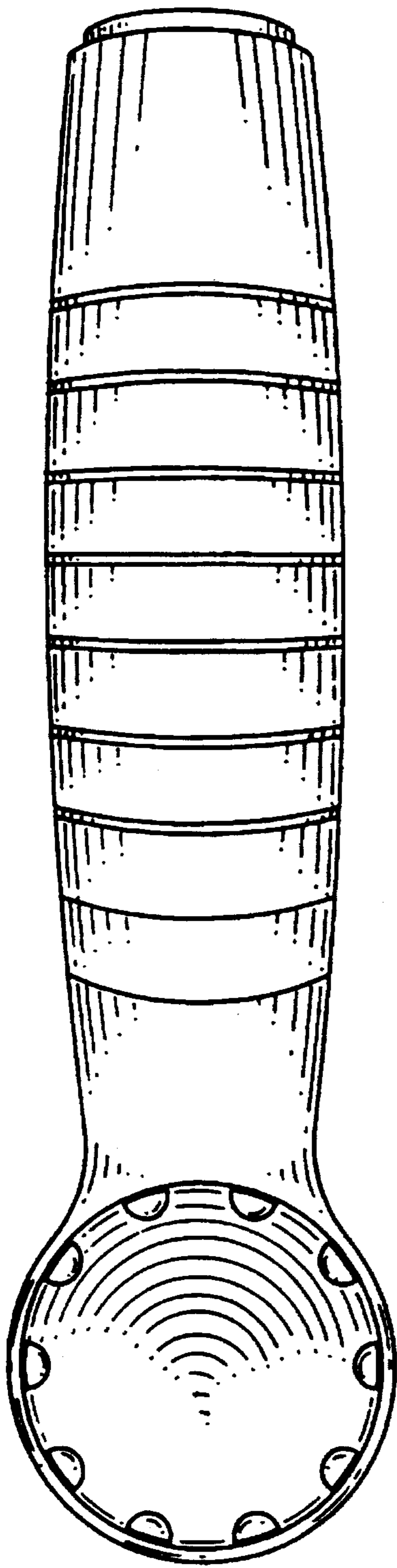

FIG. 13

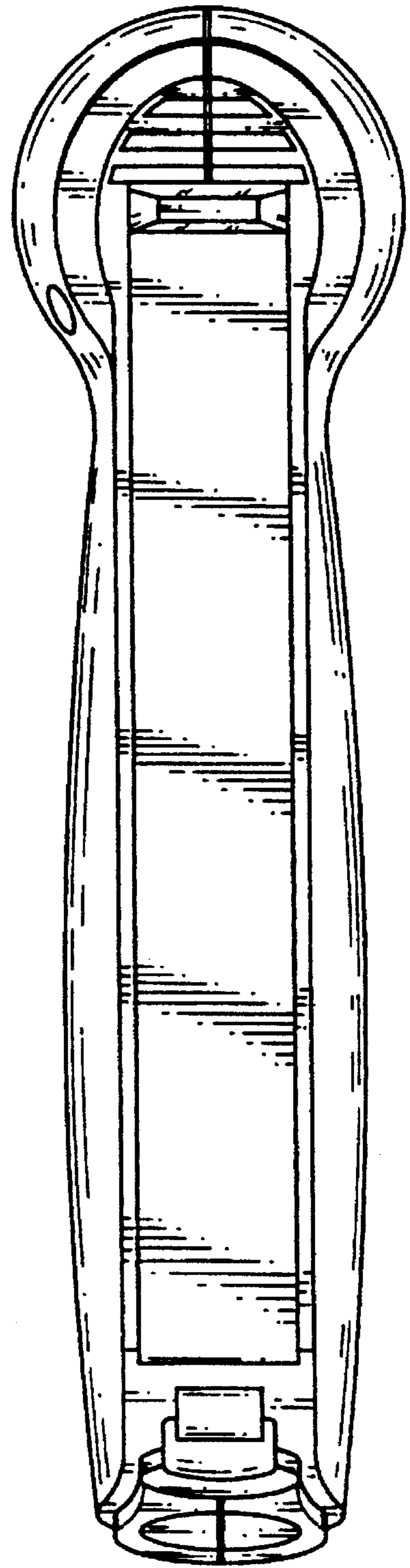

FIG. 14