



US00D373024S

United States Patent [19]
Shepherd

[11] **Patent Number: Des. 373,024**

[45] **Date of Patent: **Aug. 27, 1996**

[54] **BRUSH HEAD**

2,799,037 7/1957 Grogan 15/172

[76] Inventor: **Charles G. Shepherd**, 1008 Westdale Road, Oakville, Ontario, Canada, L6L 5A2

Primary Examiner—A. Hugo Word
Assistant Examiner—Lavone Tabor
Attorney, Agent, or Firm—Mark B. Eisen

[**] Term: **14 Years**

[57] **CLAIM**

The ornamental design for a brush head, as shown and described.

[21] Appl. No.: **37,019**

[22] Filed: **Apr. 3, 1995**

DESCRIPTION

[52] U.S. Cl. **D4/132**

[58] **Field of Search** D4/116, 118, 130, D4/132, 135, 138; D32/40, 50; 15/159.1, 160, 171, 172, 186, 187, 176.1

FIG. 1 is a perspective view of the brush head;
FIG. 2 is a side elevation;
FIG. 3 is a top plan view;
FIG. 4 is a bottom plan view;
FIG. 5 is a side elevation taken opposite FIG. 2;
FIG. 6 is a front end elevation; and,
FIG. 7 is a rear end elevation.

[56] **References Cited**

U.S. PATENT DOCUMENTS

D. 270,971 10/1983 Stevens et al. D4/132
2,044,595 6/1936 Schumann 15/171

1 Claim, 1 Drawing Sheet

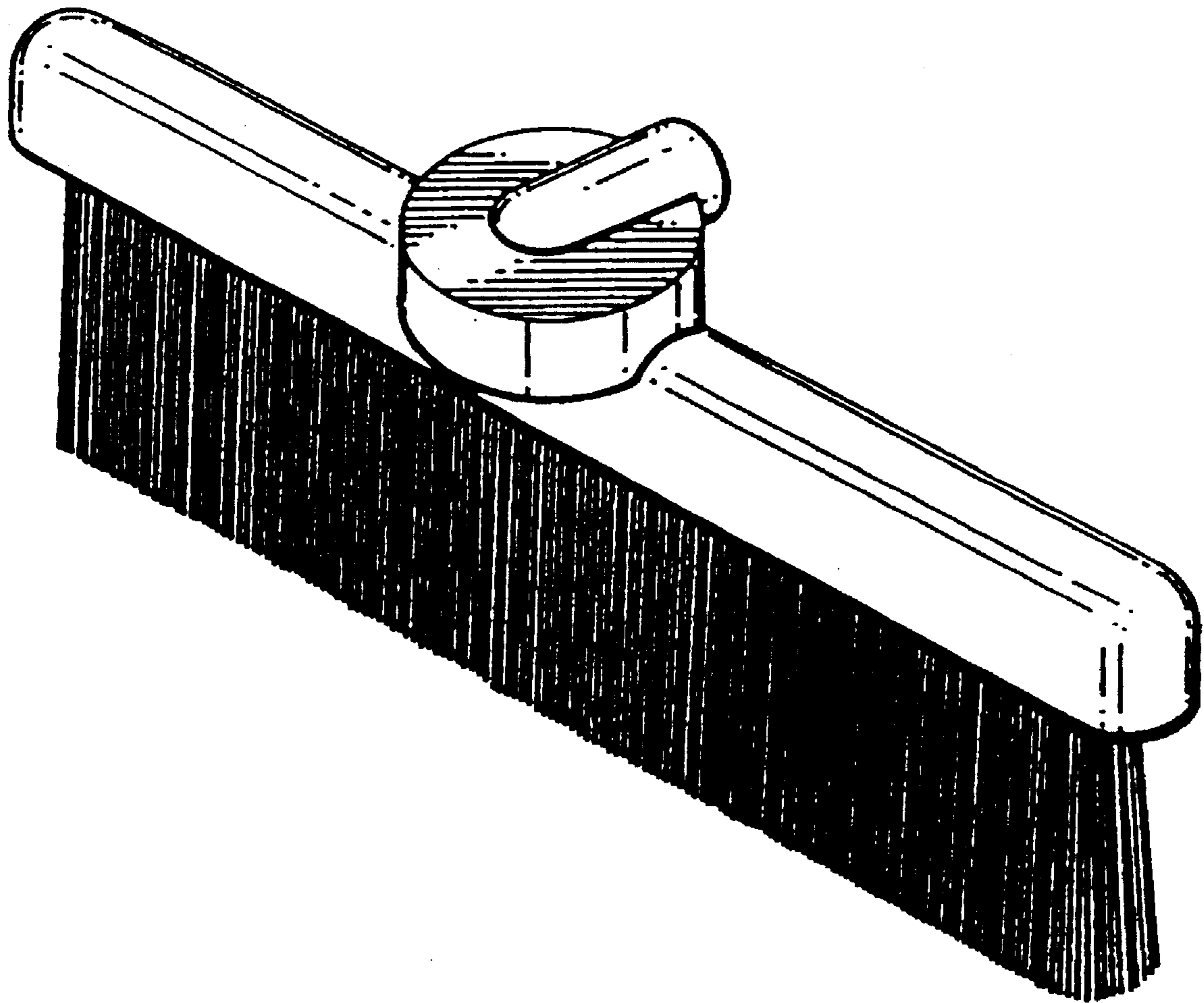

FIG. 1

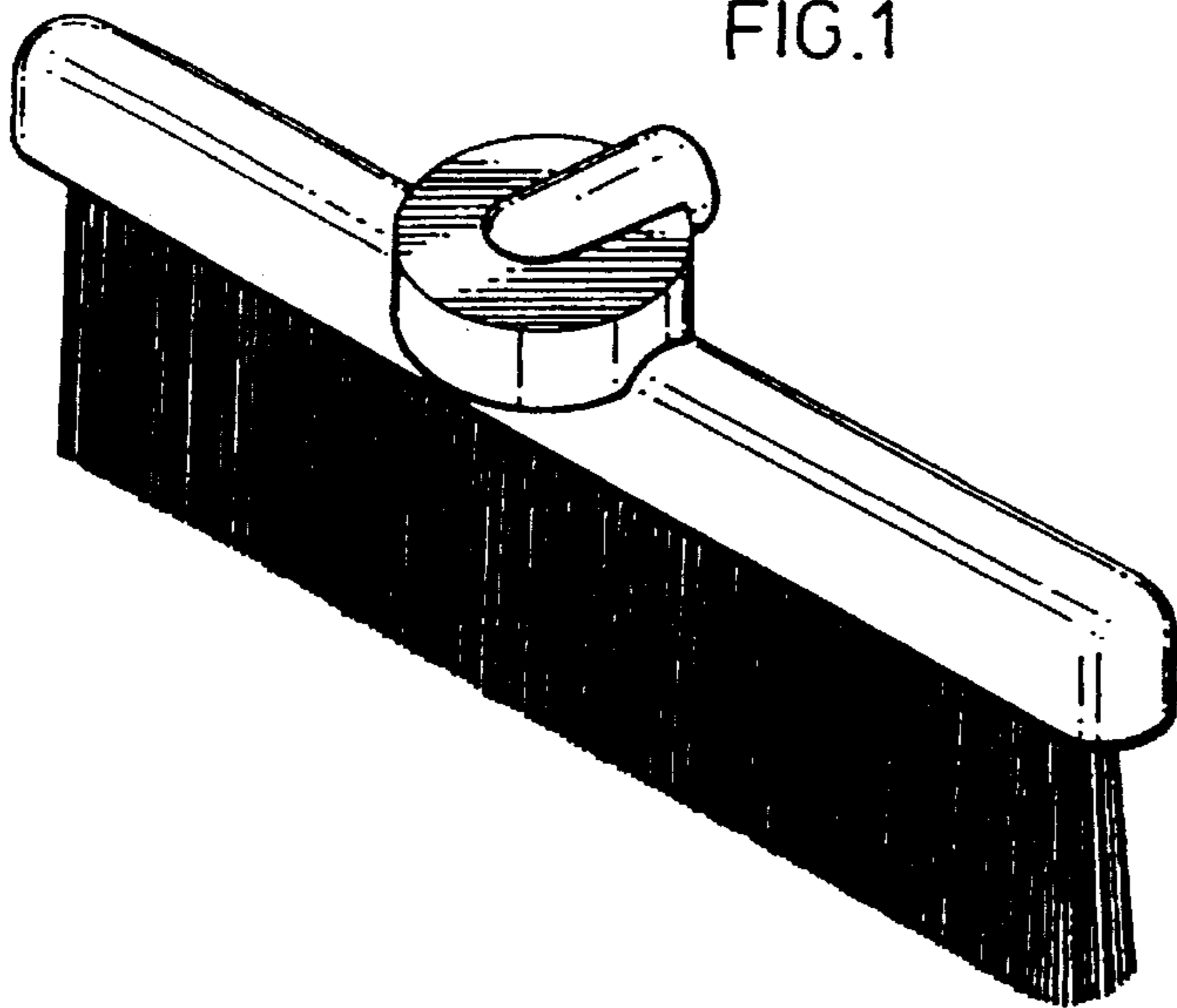

FIG. 2

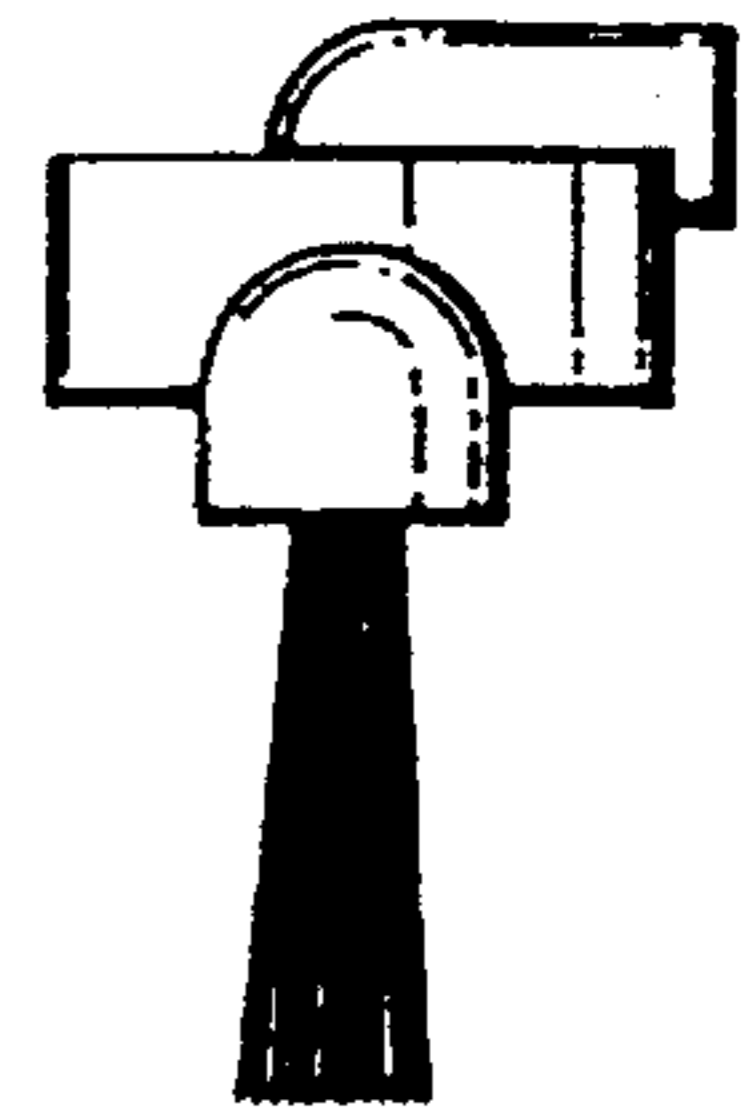

FIG. 3

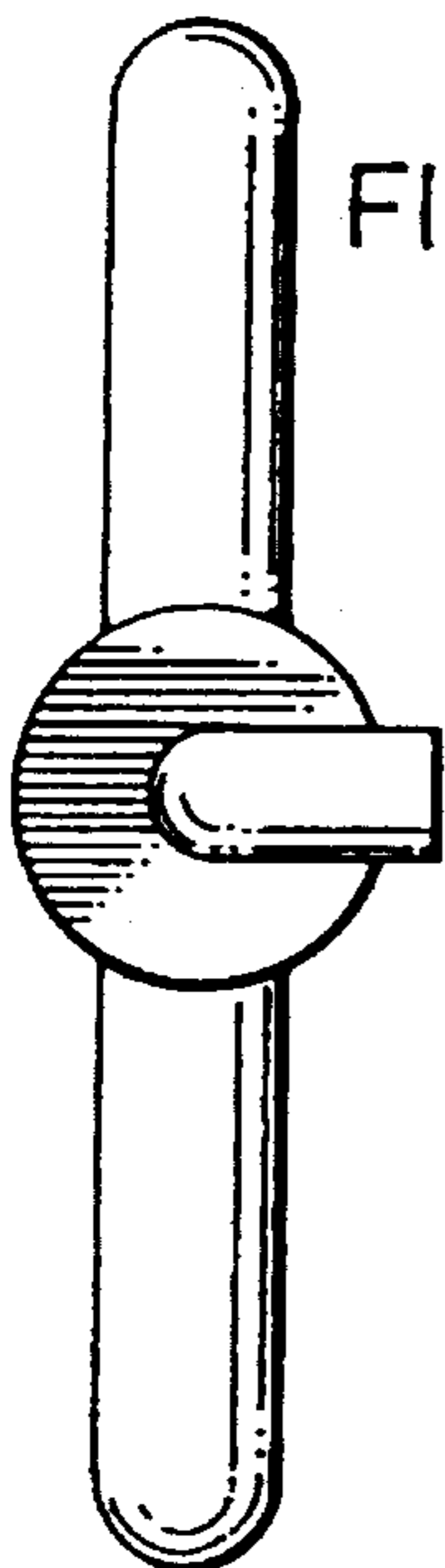

FIG. 4

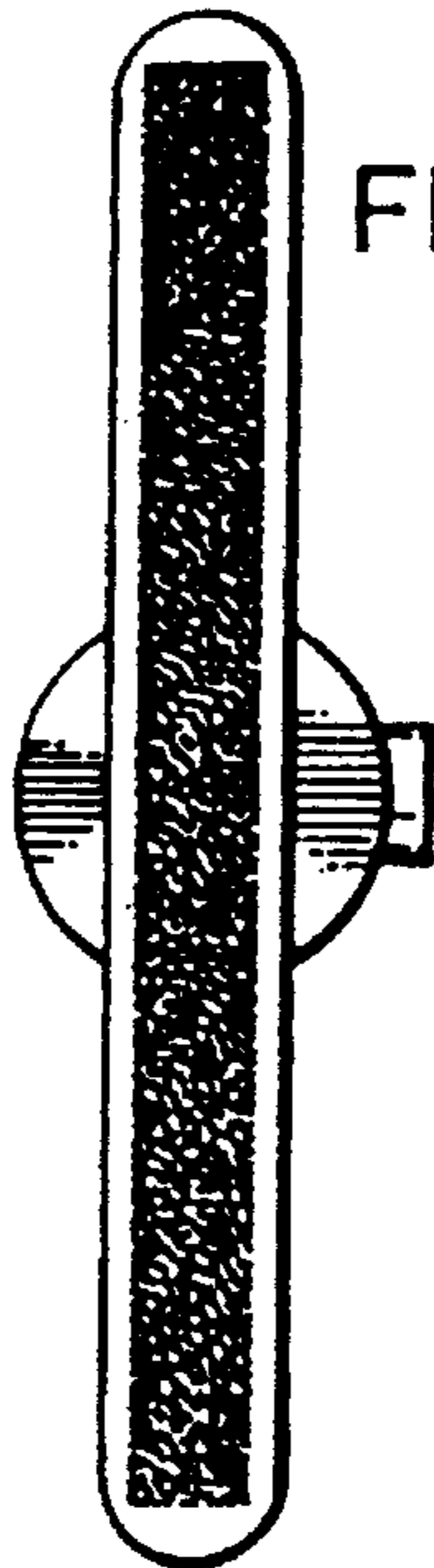

FIG. 5

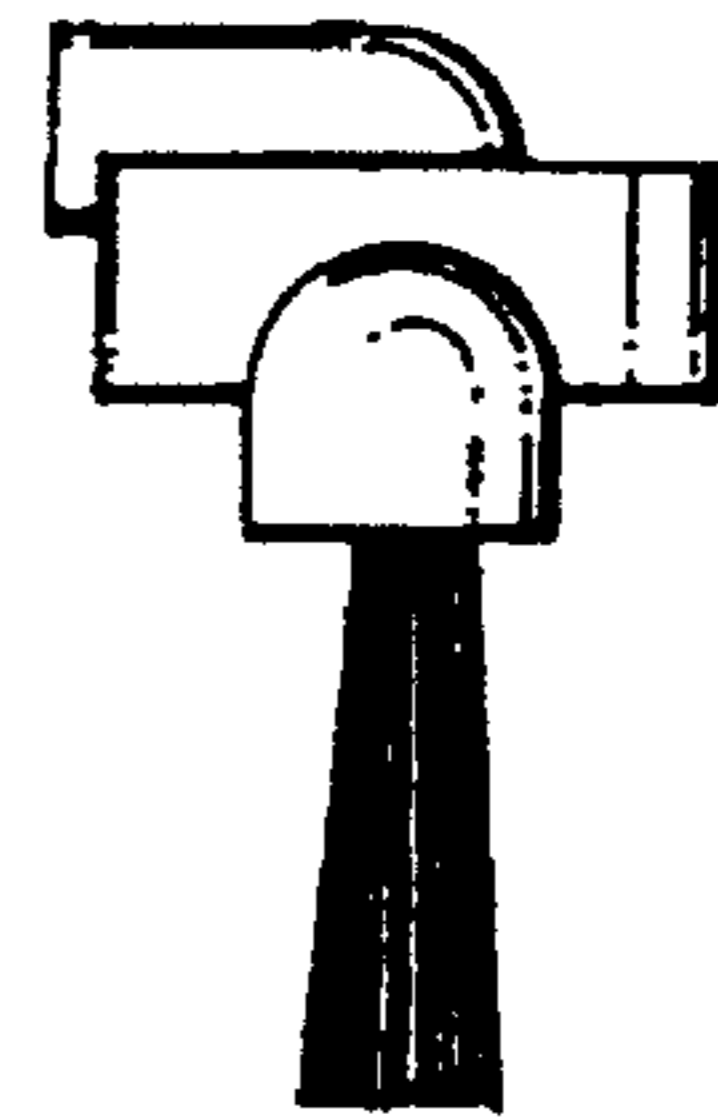

FIG. 6

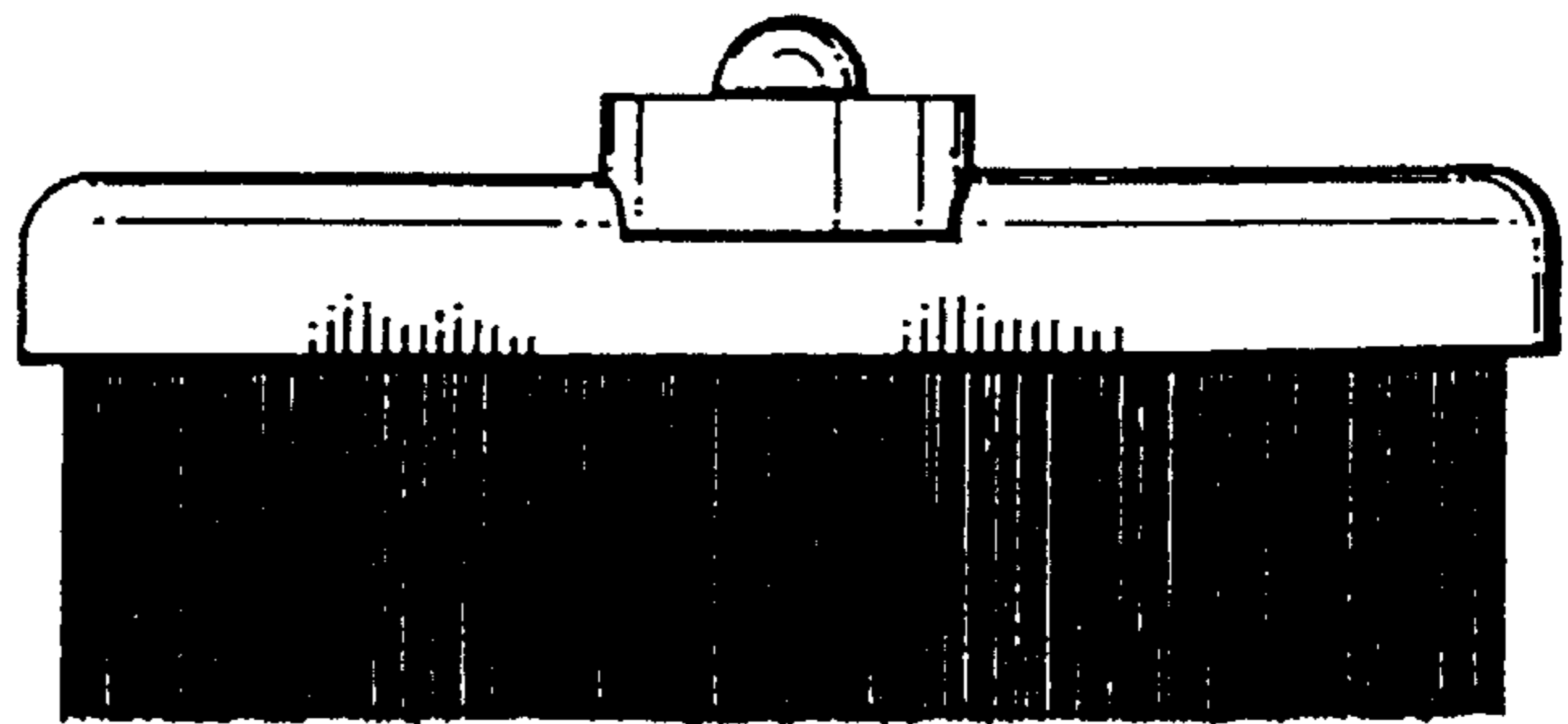

FIG. 7

