



US00D372998S

United States Patent [19] Carbone

[11] Patent Number: **Des. 372,998**

[45] Date of Patent: ****Aug. 20, 1996**

[54] **HEAD FOR A FLASHLIGHT**

[75] Inventor: **Richard J. Carbone**, Southbury, Conn.

[73] Assignee: **Black & Decker Inc.**, Newark, Del.

[**] Term: **14 Years**

[21] Appl. No.: **39,170**

[22] Filed: **May 22, 1995**

[52] U.S. Cl. **D26/43**

[58] Field of Search D26/37-50; 362/157,
362/158, 184, 188, 189, 191, 198, 199,
200, 255, 396

[56] **References Cited**

U.S. PATENT DOCUMENTS

D. 366,710	1/1996	Szymanski	D26/43
D. 366,948	2/1996	Carbone	D26/43
1,692,394	11/1928	Sundh	362/198
2,092,672	9/1937	Hyatt	D26/43

Primary Examiner—Marcus A. Jackson
Attorney, Agent, or Firm—Barry E. Deutsch

[57] **CLAIM**

The ornamental design for a head for a flashlight, as shown and described.

DESCRIPTION

FIG. 1 is a perspective view of a head for a flashlight showing my new design, with the broken line showing for illustrative purposes only and forming no part of the claimed design;

FIG. 2 is a right side elevational view thereof;

FIG. 3 is a left side elevational view thereof;

FIG. 4 is a front elevational view thereof;

FIG. 5 is a rear elevational view thereof;

FIG. 6 is a top plan view thereof; and,

FIG. 7 is a bottom plan view thereof.

1 Claim, 3 Drawing Sheets

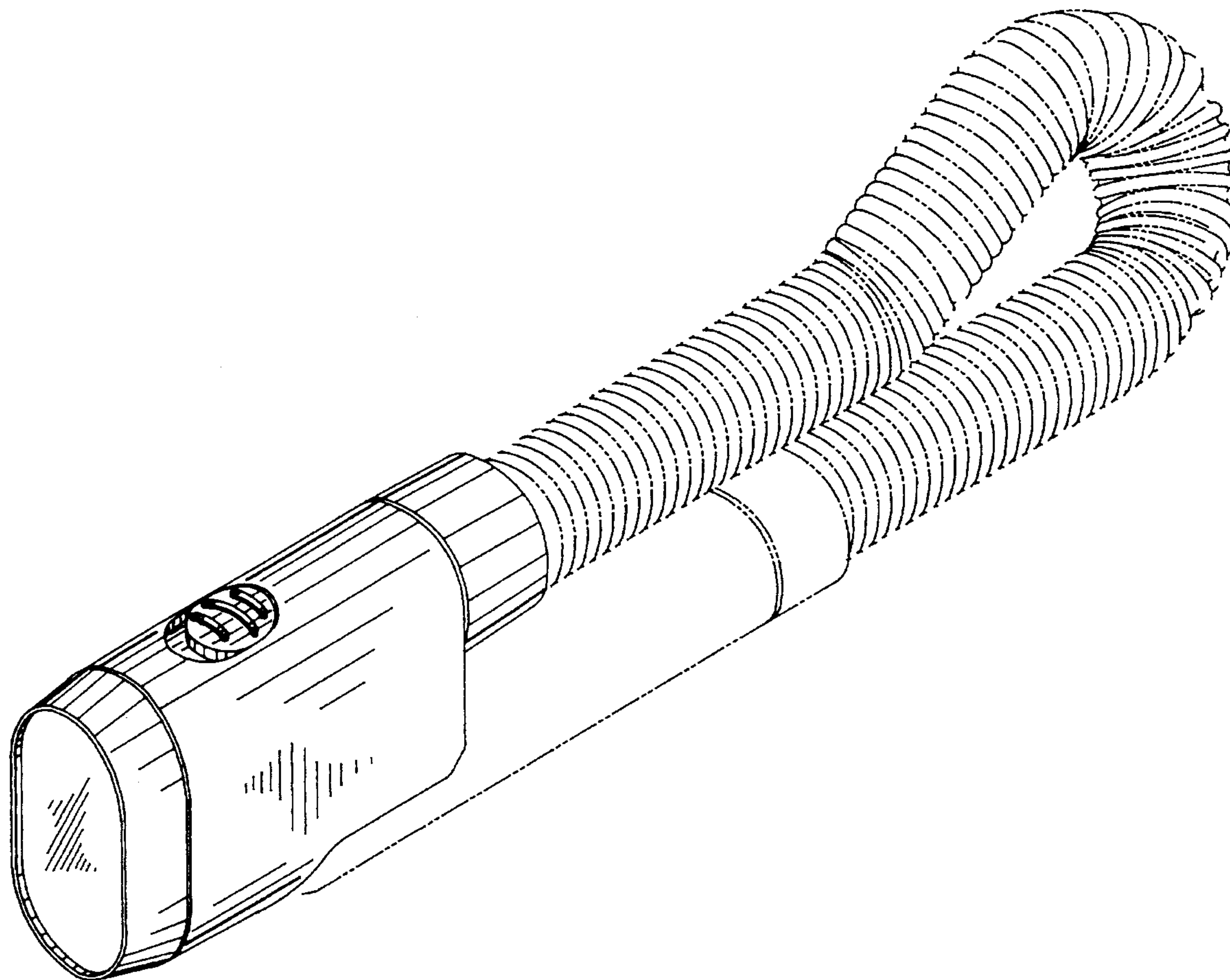

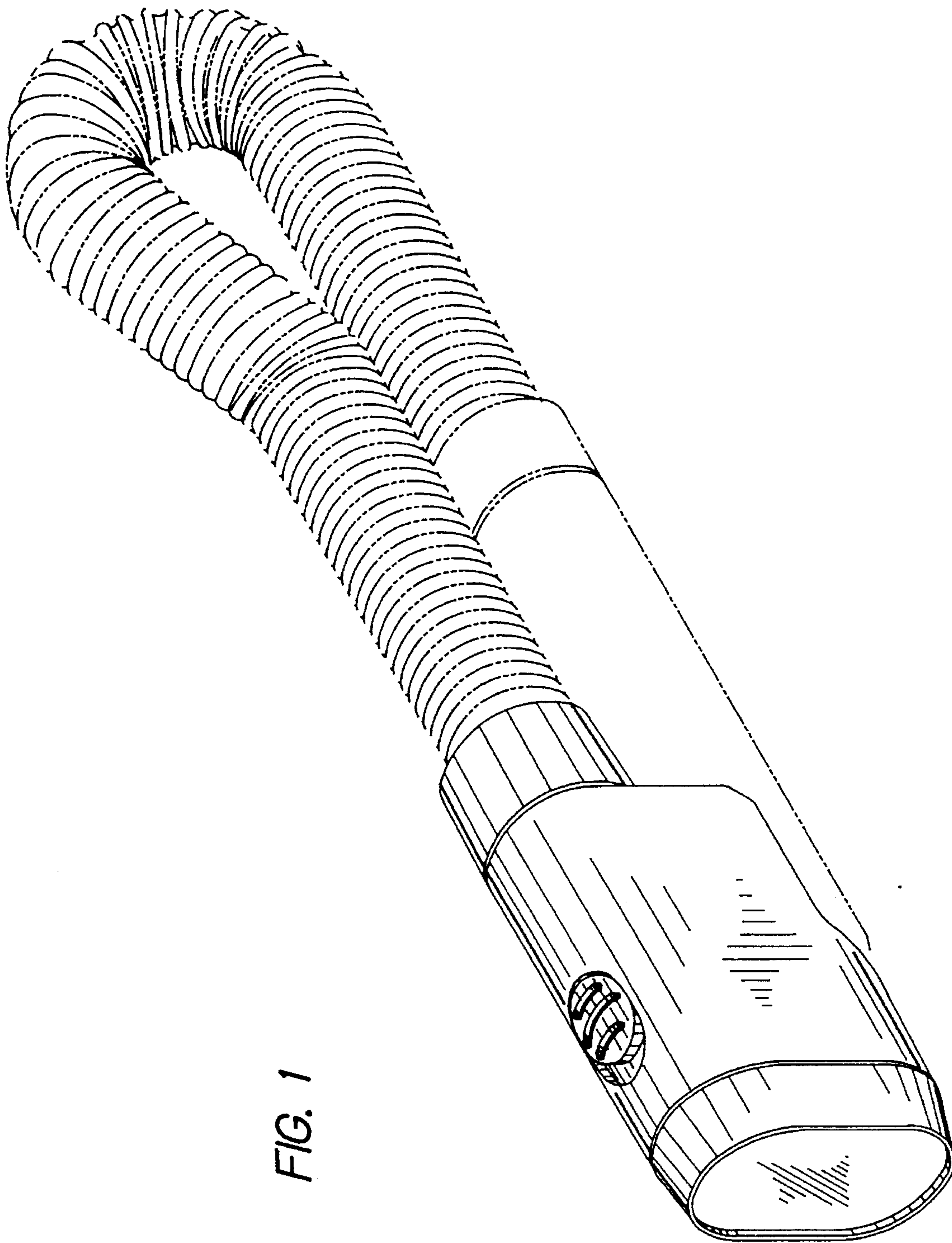

FIG. 1

FIG. 2

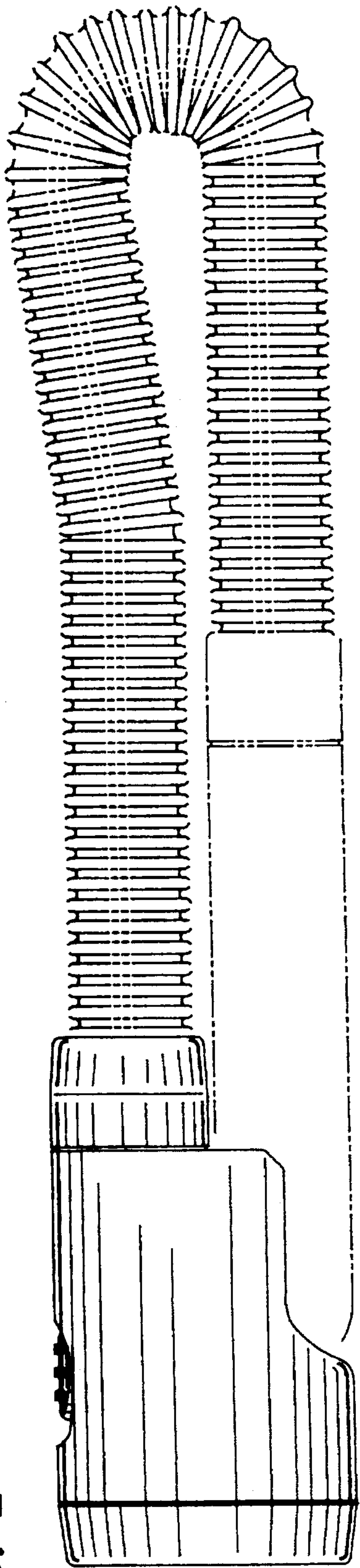

FIG. 3

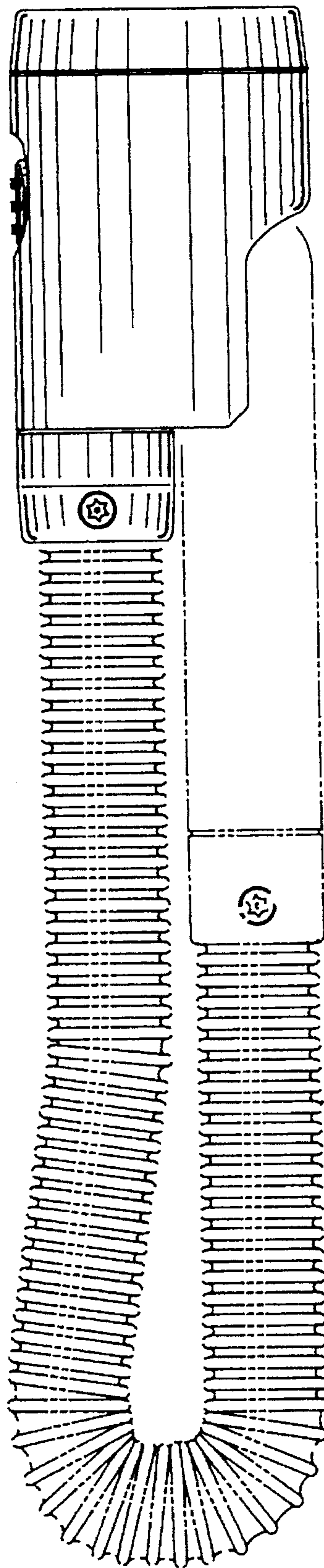

FIG. 5

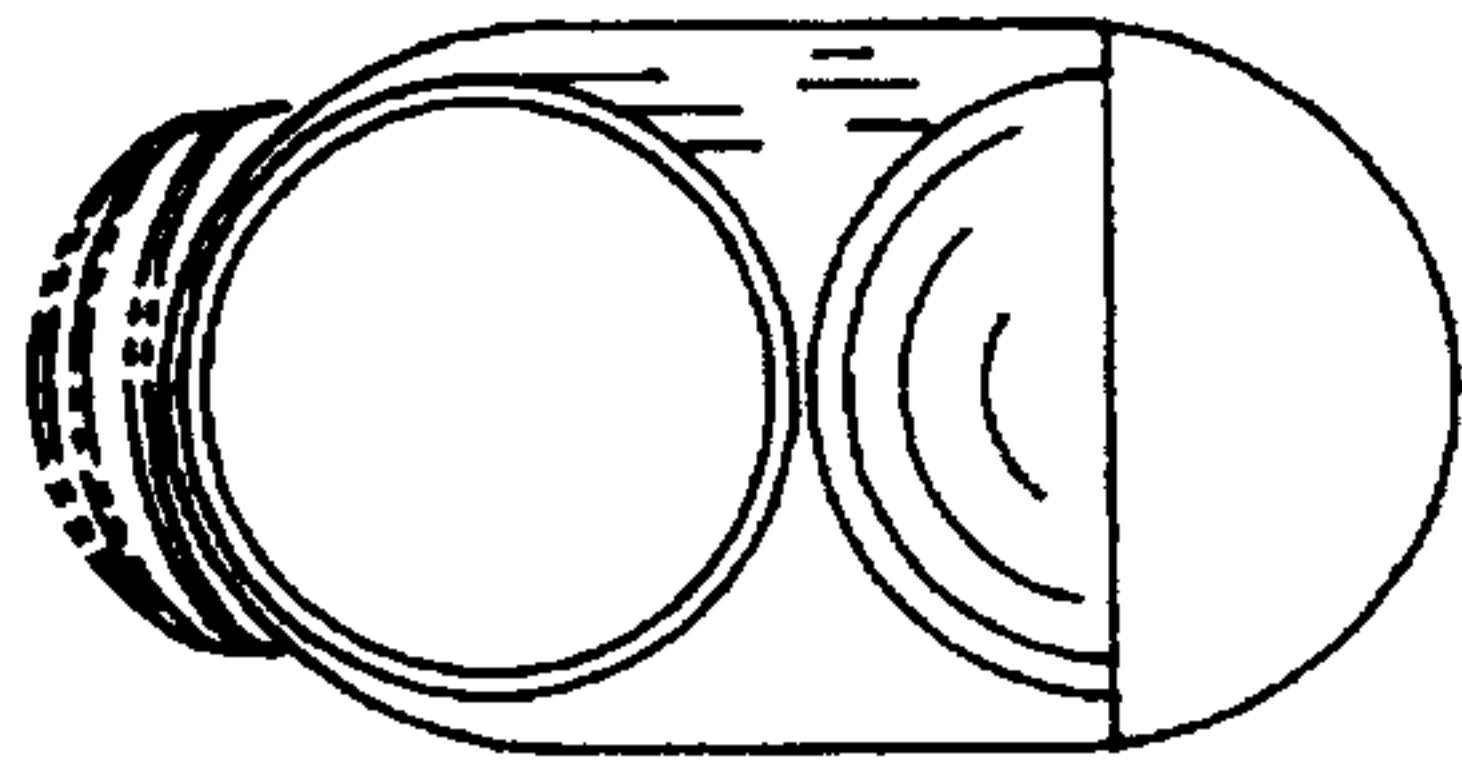

FIG. 4

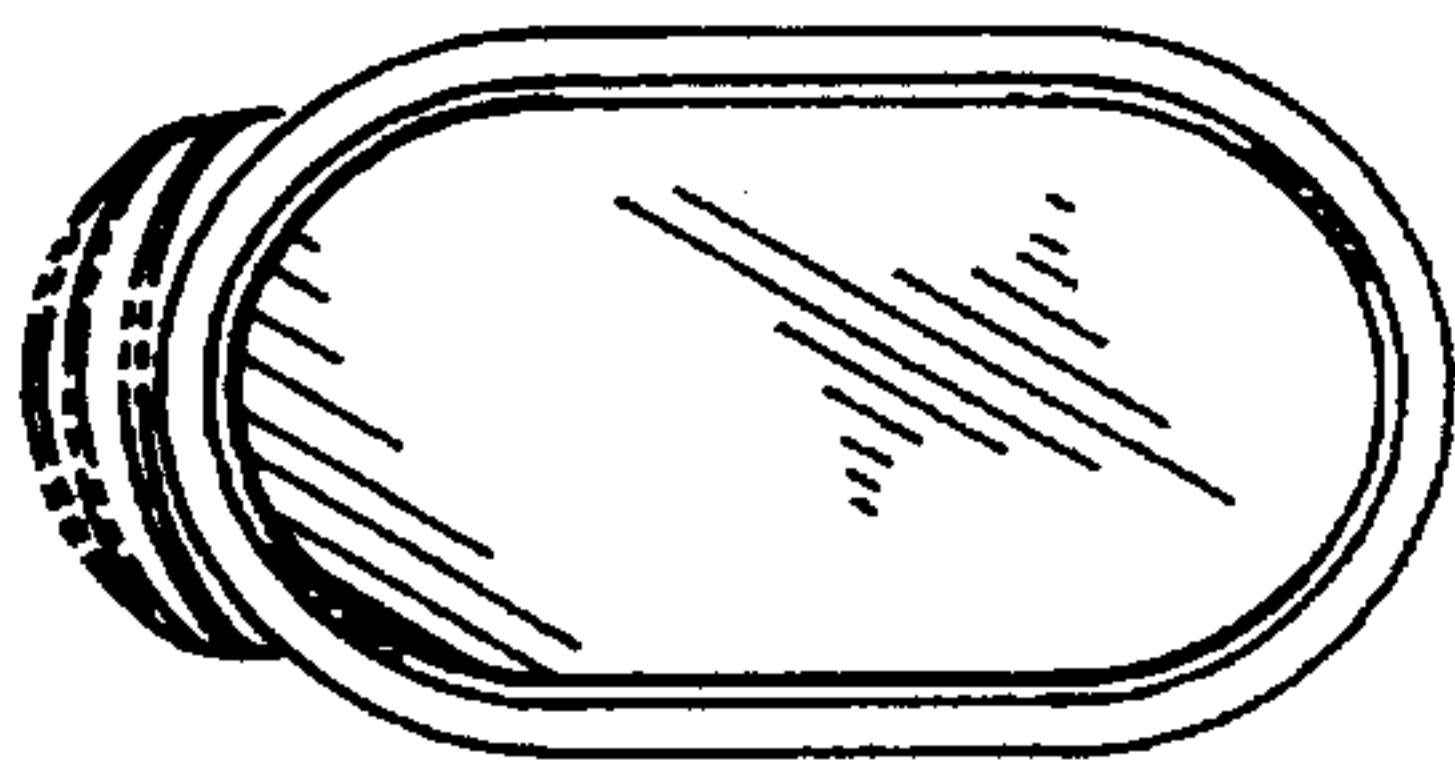

FIG. 6

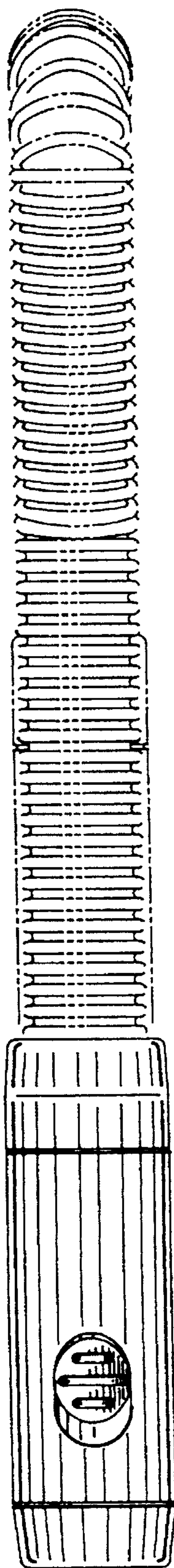

FIG. 7

