



US00D372844S

United States Patent [19]

Nunes

[11] Patent Number: **Des. 372,844**

[45] Date of Patent: ****Aug. 20, 1996**

[54] **REUSABLE BEVERAGE CAN GRIP**

[76] Inventor: **James Nunes**, 12129 Arrowwood Dr., Austin, Tex. 78727

[**] Term: **14 Years**

[21] Appl. No.: **38,943**

[22] Filed: **May 17, 1995**

Related U.S. Application Data

- [63] Continuation-in-part of Ser. No. 327,199, Oct. 21, 1994.
- [52] U.S. Cl. **D7/622**
- [58] Field of Search D7/619-622; 16/114 R; 220/737, 741, 742, 755, 756, 759, 769; 248/310, 311.2, 312.1; 294/27.1, 32, 33

[56] **References Cited**

U.S. PATENT DOCUMENTS

D. 232,614	9/1974	Brown	D7/622
D. 303,336	9/1989	Webster	D7/622
2,010,317	8/1935	Olson .	
2,424,094	7/1947	Herr .	
2,665,936	1/1954	Moore .	
2,838,202	6/1958	Huether .	
3,014,621	12/1961	Povitz .	
3,029,975	4/1962	Aiello .	
3,189,937	6/1965	Sciortino .	
3,261,635	7/1966	Talay	220/737 X
3,825,151	7/1974	Arnaud .	
4,127,915	12/1978	Logan et al.	D7/622 X

4,602,723	7/1986	DeMars	220/742
4,898,297	2/1990	Wheeler .	
4,993,675	2/1991	Walker .	
5,054,638	10/1991	Rose .	
5,203,471	4/1993	Widman .	

OTHER PUBLICATIONS

Applicant has a co-pending application entitled "Reusable Beverage Can Grip" filed Oct. 21, 1994, Ser. No. 08/327,199.

Primary Examiner—Terry A. Wallace
Attorney, Agent, or Firm—Novak Druce Reynolds Burt

[57] **CLAIM**

The ornamental design for a reusable beverage can grip, as shown and described.

DESCRIPTION

FIG. 1 is a top, front, right side perspective view of a reusable beverage can grip showing my new design; FIG. 2 is a right side elevation view thereof, the opposite side being a mirror image; FIG. 3 is a front elevation view thereof; FIG. 4 is a rear elevation view thereof; FIG. 5 is a top plan view thereof; FIG. 6 is a bottom plan view thereof; FIG. 7 is a cross-sectional view taken along line 7—7 of FIG. 2; and, FIG. 8 is a cross-sectional view taken along line 8—8 of FIG. 2.

1 Claim, 1 Drawing Sheet

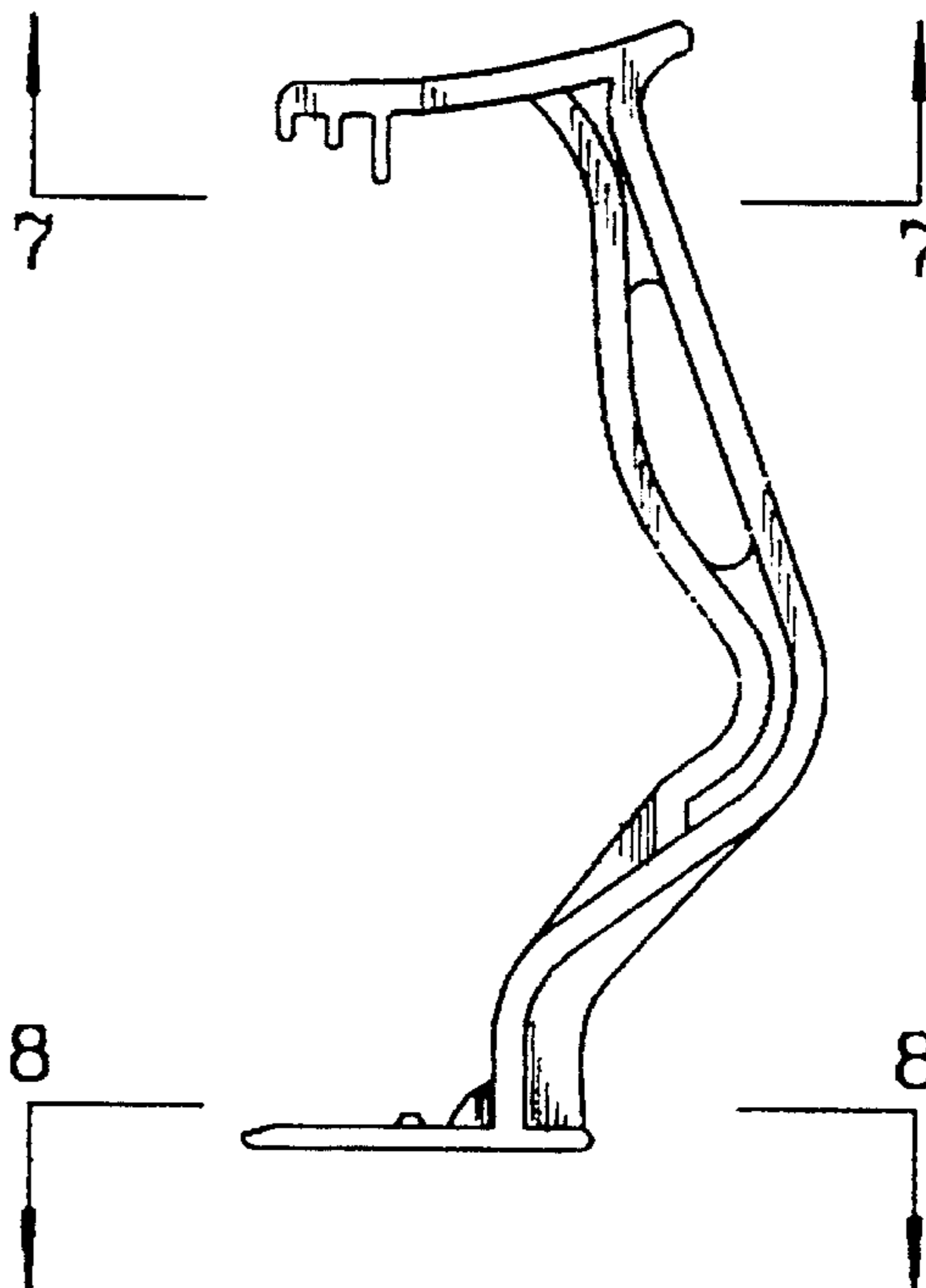
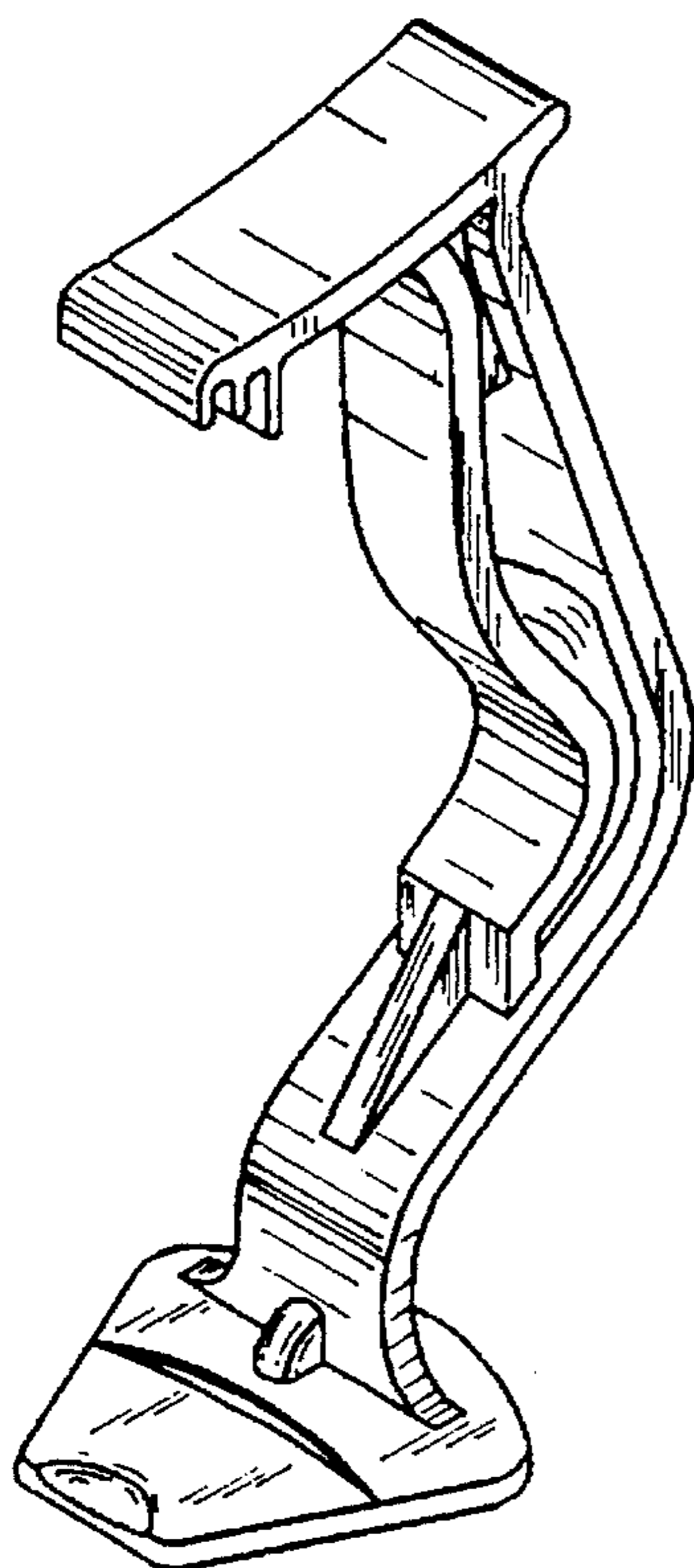

FIG. 1

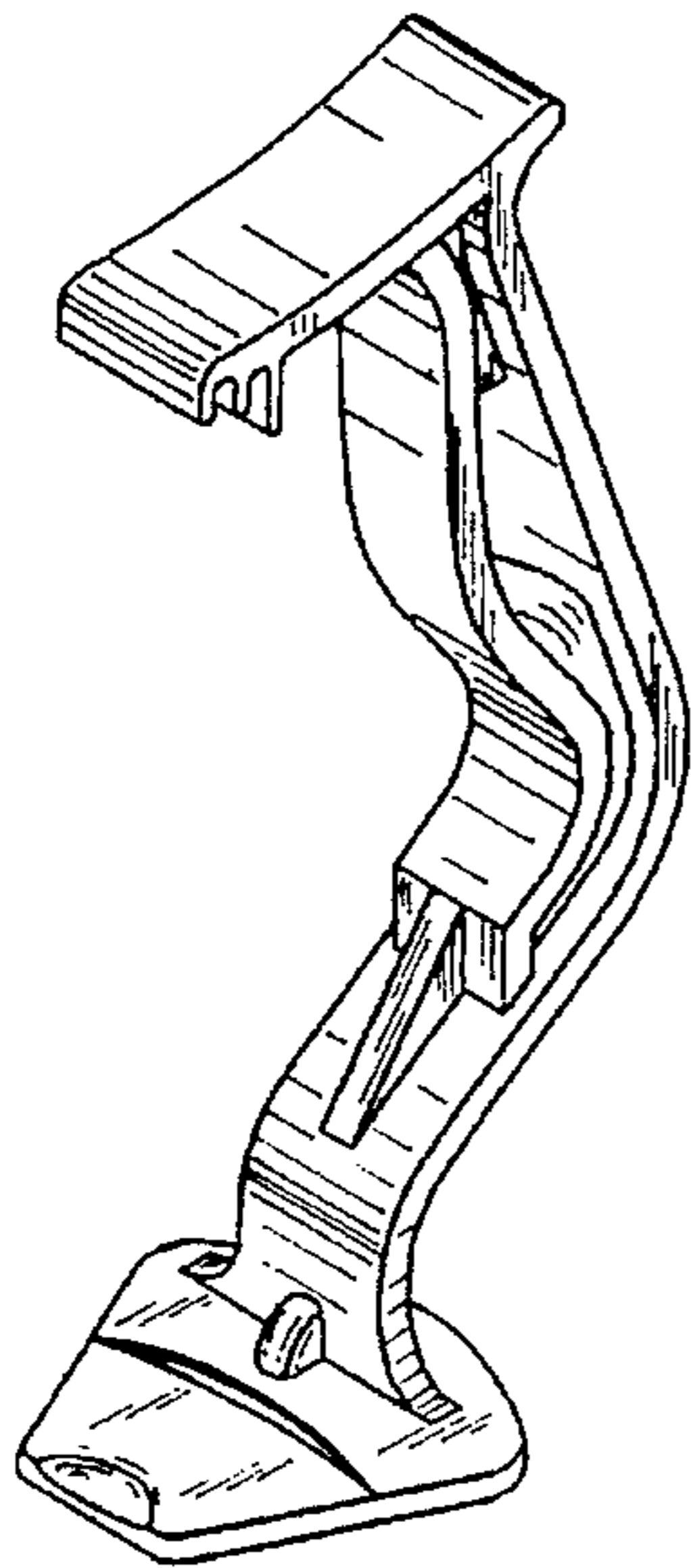

FIG. 2

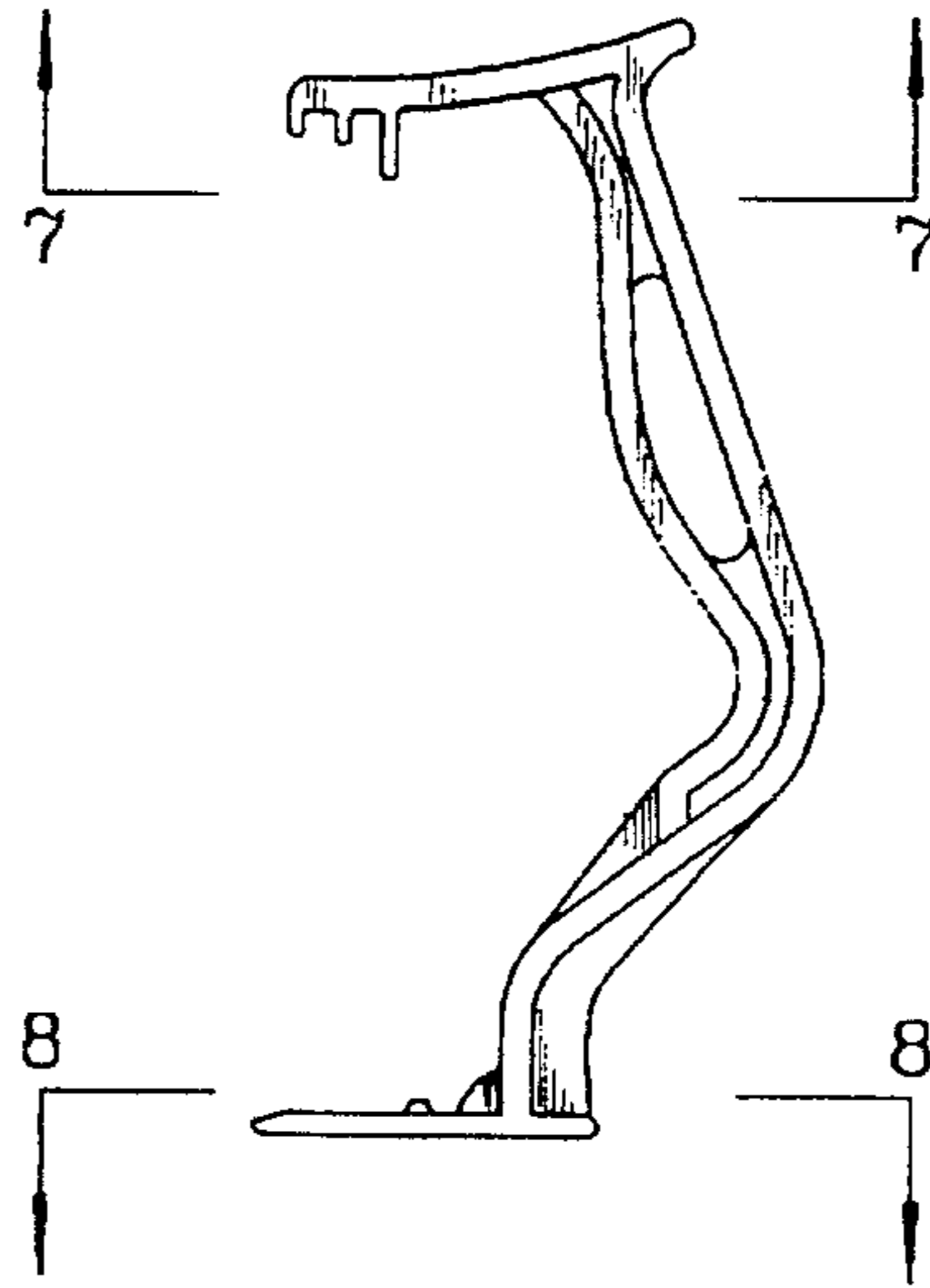

FIG. 3

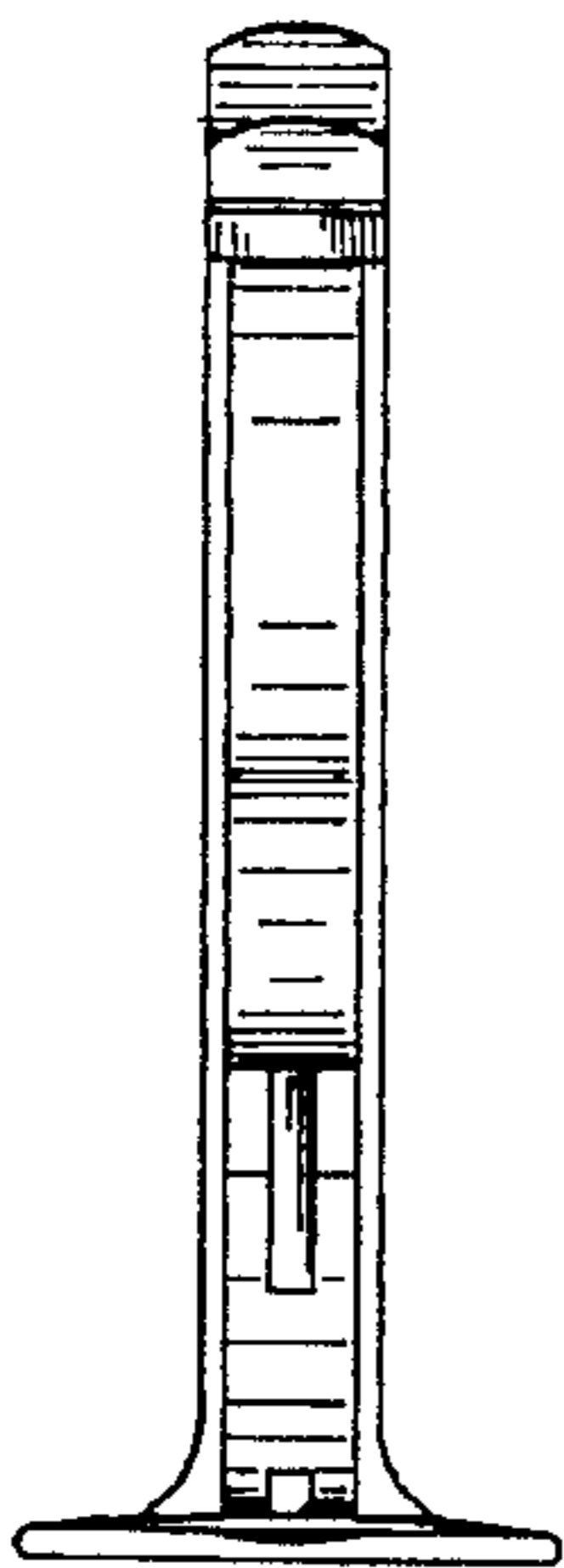

FIG. 4

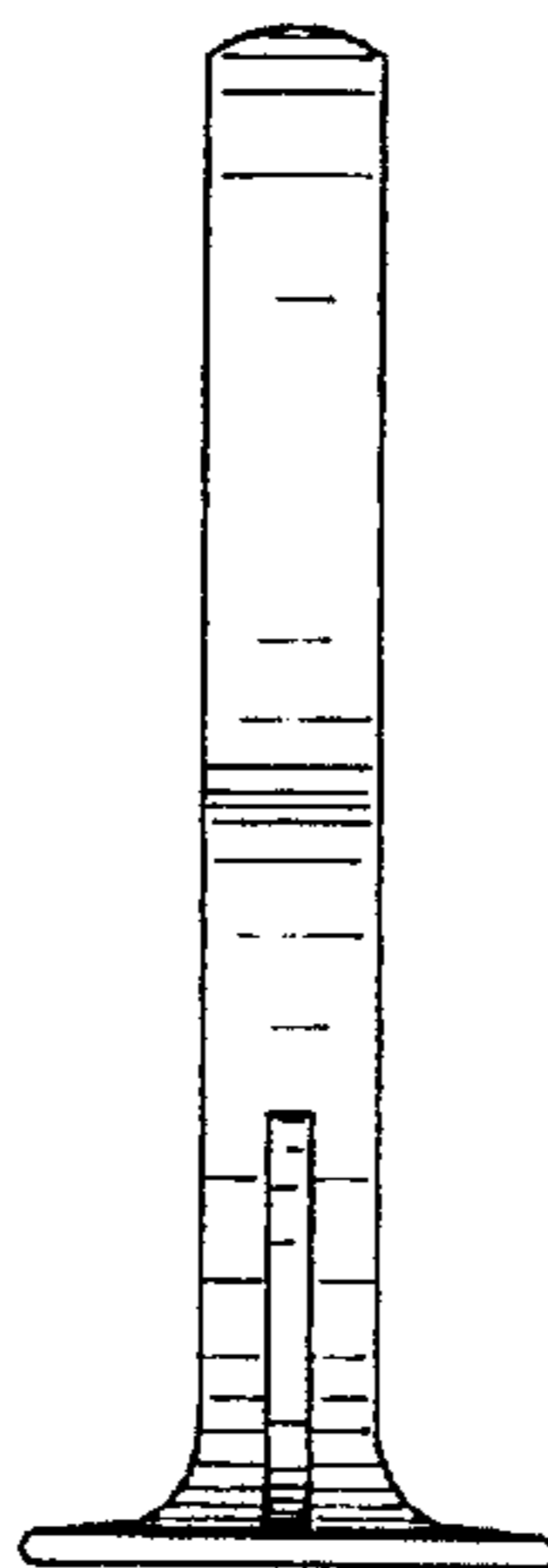

FIG. 5

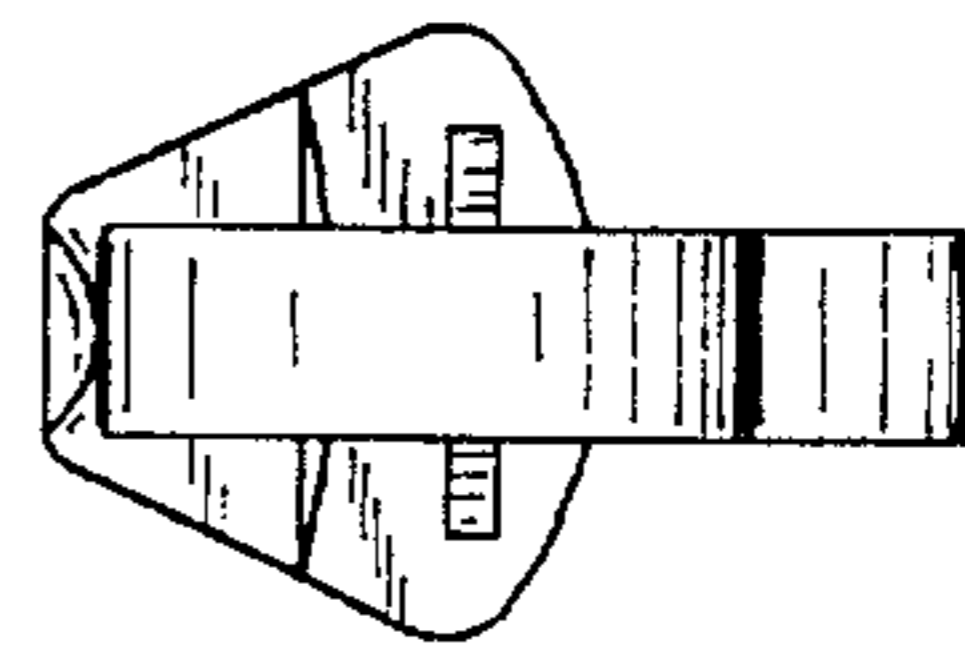

FIG. 6

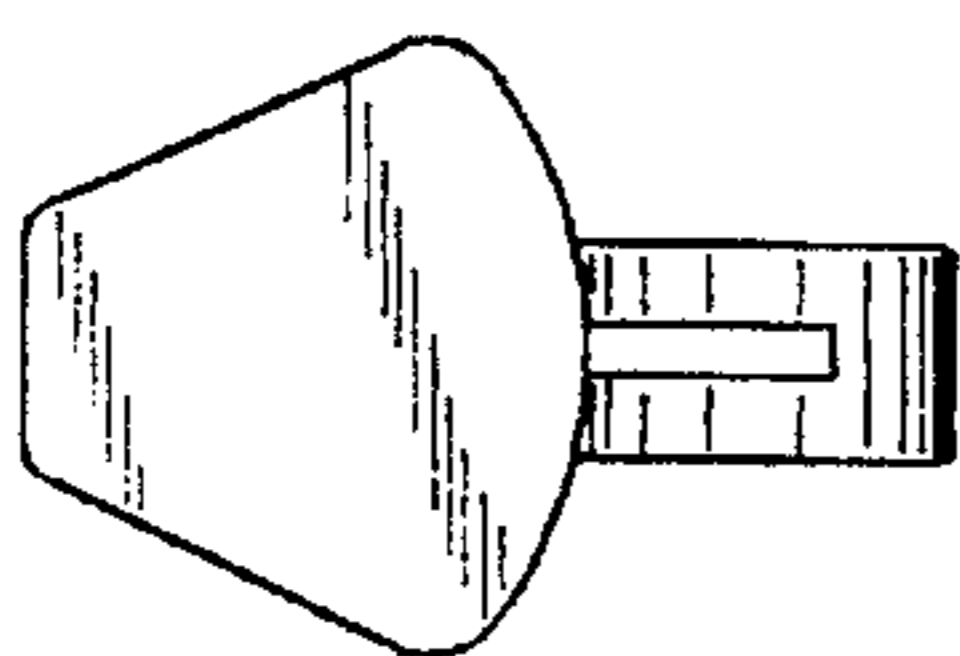

FIG. 7



FIG. 8

