



US00D372813S

# United States Patent [19]

Walter

[11] Patent Number: **Des. 372,813**

[45] Date of Patent: **\*\*Aug. 20, 1996**

[54] **KITTY LITTER CABINET**

5,167,205 12/1992 Bell et al. .

[76] Inventor: **Teresa L. Walter**, 26001 L. Brigadier Pl., Damascus, Md. 20872

### FOREIGN PATENT DOCUMENTS

2584567 1/1987 France ..... D30/161  
1316202 5/1973 United Kingdom ..... 119/164

[\*\*] Term: **14 Years**

*Primary Examiner*—Carmen H. Vales-Lado

[21] Appl. No.: **34,678**

### [57] CLAIM

[22] Filed: **Feb. 9, 1995**

The ornamental design for the kitty litter cabinet, as shown and described.

[52] U.S. Cl. .... **D6/436**; D30/161

[58] Field of Search ..... D6/436, 396, 397;  
D30/161; D34/19, 20, 21; 119/15, 19, 161,  
163, 165, 167, 168

### DESCRIPTION

### [56] References Cited

#### U.S. PATENT DOCUMENTS

D. 92,270 5/1934 Schmid ..... D6/436  
D. 122,687 9/1940 Kranz ..... D6/436  
D. 192,851 5/1962 Antonio et al. .... D34/20  
D. 202,337 9/1965 Vaughan ..... D34/20  
D. 245,191 7/1977 Gore .  
D. 271,733 12/1983 Daventry ..... D6/436  
D. 312,897 12/1990 Splane ..... D30/161  
3,885,523 5/1975 Coleman ..... D30/161 X  
5,014,649 5/1991 Taft .  
5,044,325 9/1991 Miksitz .  
5,140,948 8/1992 Roberts .

FIG. 1 is a front elevational view of the kitty litter cabinet showing my new design;  
FIG. 2 is a rear elevational view thereof;  
FIG. 3 is a left side elevational view thereof;  
FIG. 4 is a right side elevational view thereof;  
FIG. 5 is a top plan view thereof;  
FIG. 6 is a bottom plan view thereof;  
FIG. 7 is a cross-sectional view thereof, taken along line 7—7 of FIG. 5, the broken line showing of the litter box for illustrative purposes only and forming no part of the claimed design; and,  
FIG. 8 is an upper left perspective view thereof.

**1 Claim, 4 Drawing Sheets**

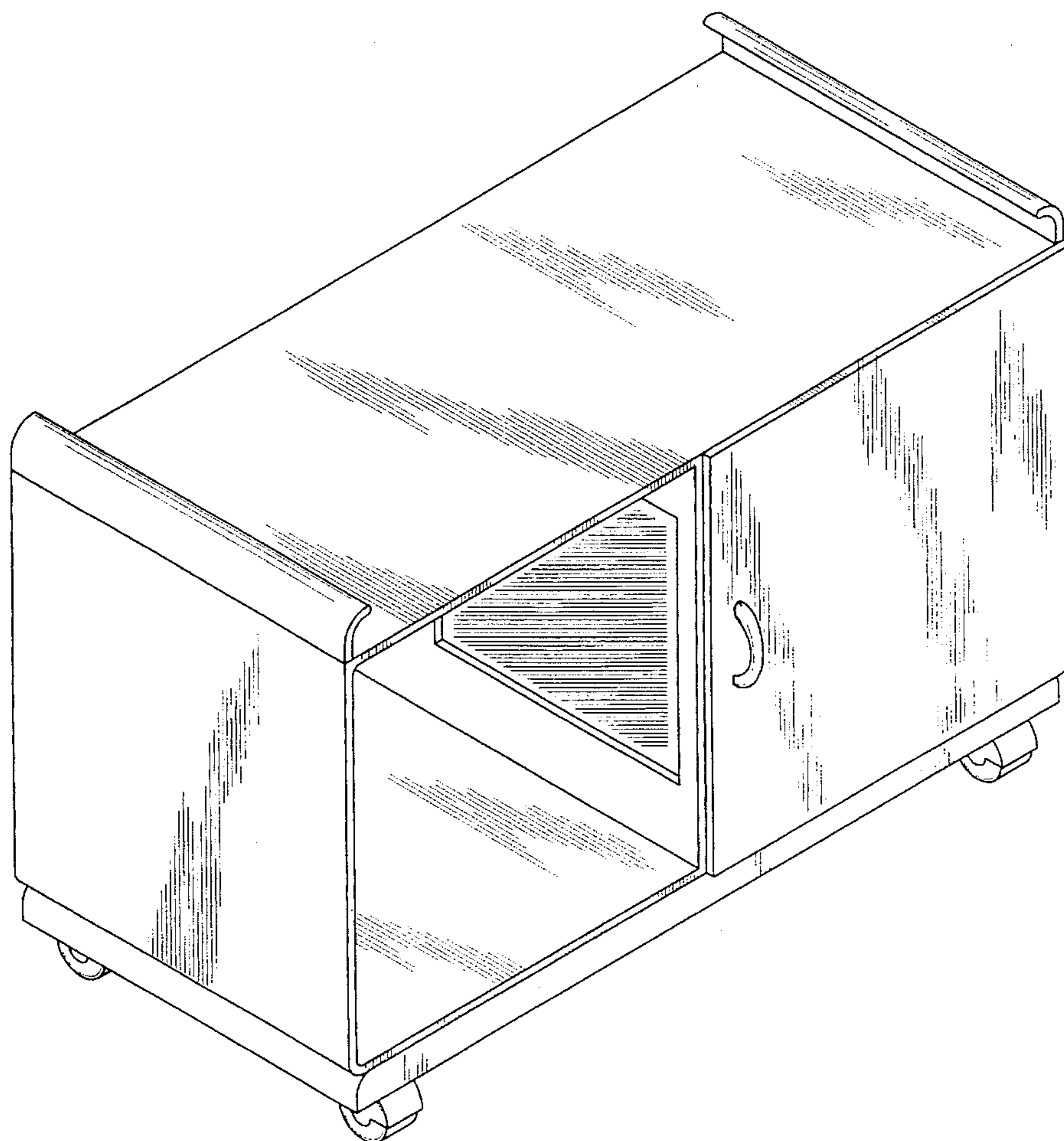

FIG. 1

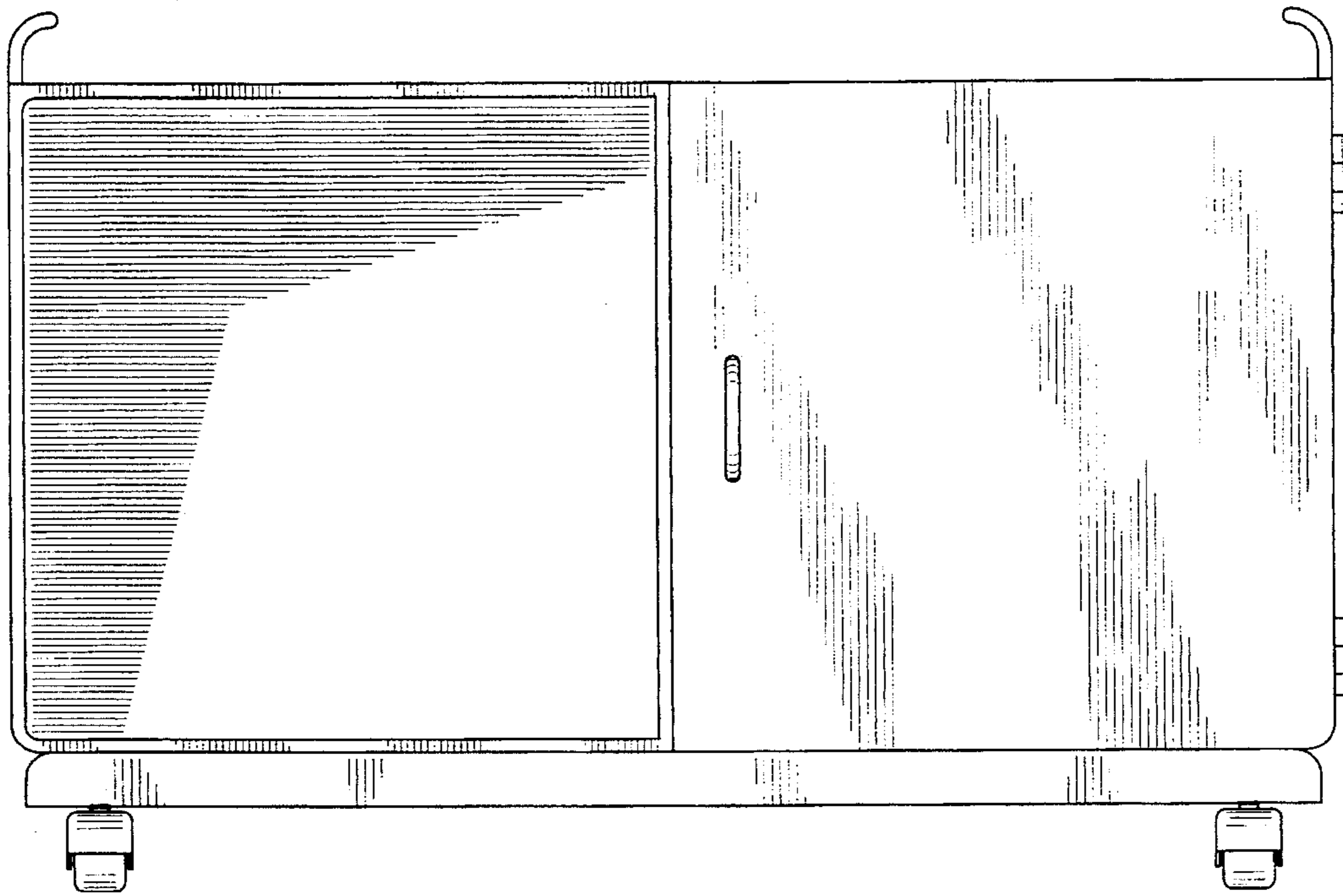

FIG. 2

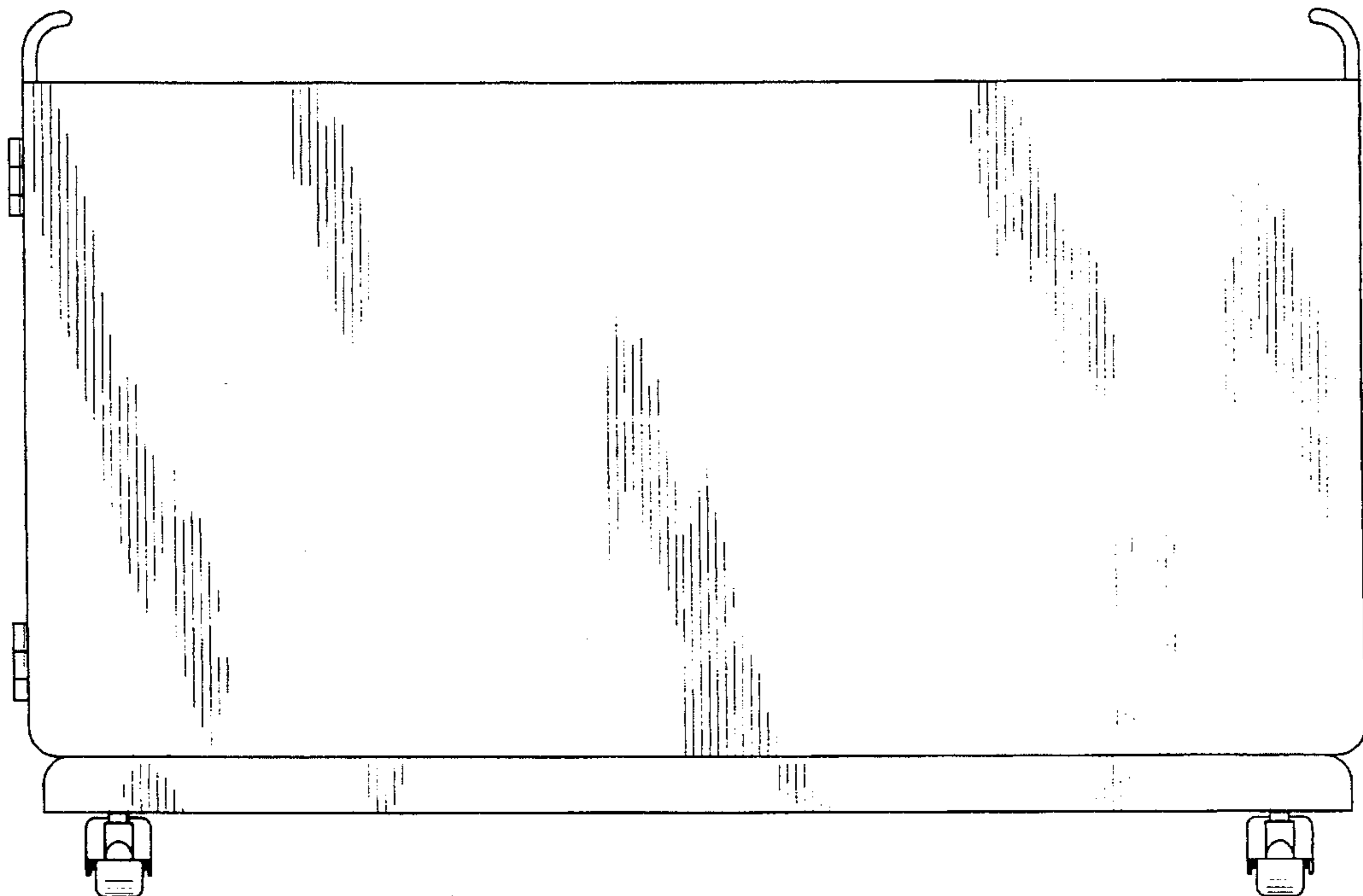

FIG. 3

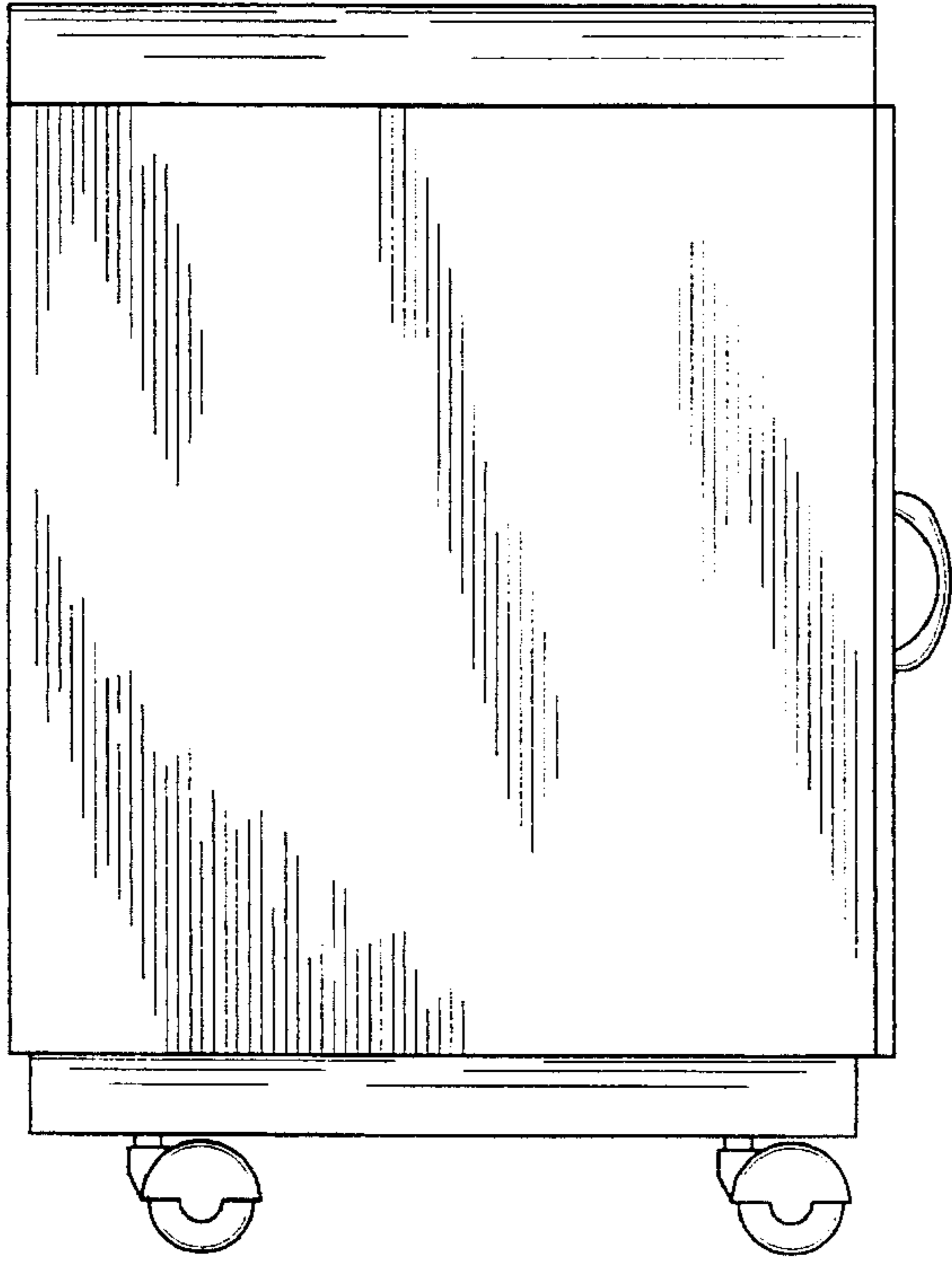

FIG. 4

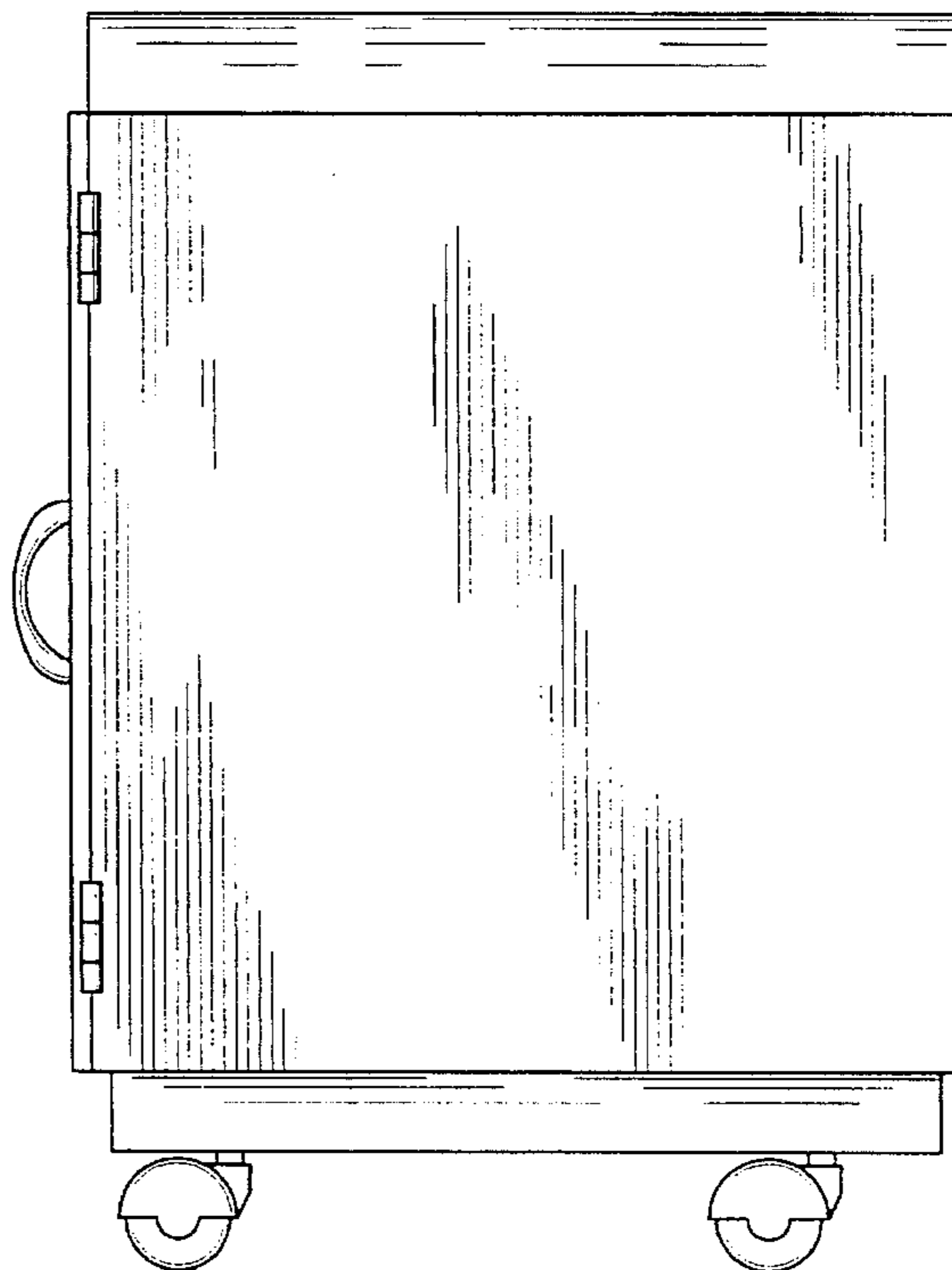

FIG. 5

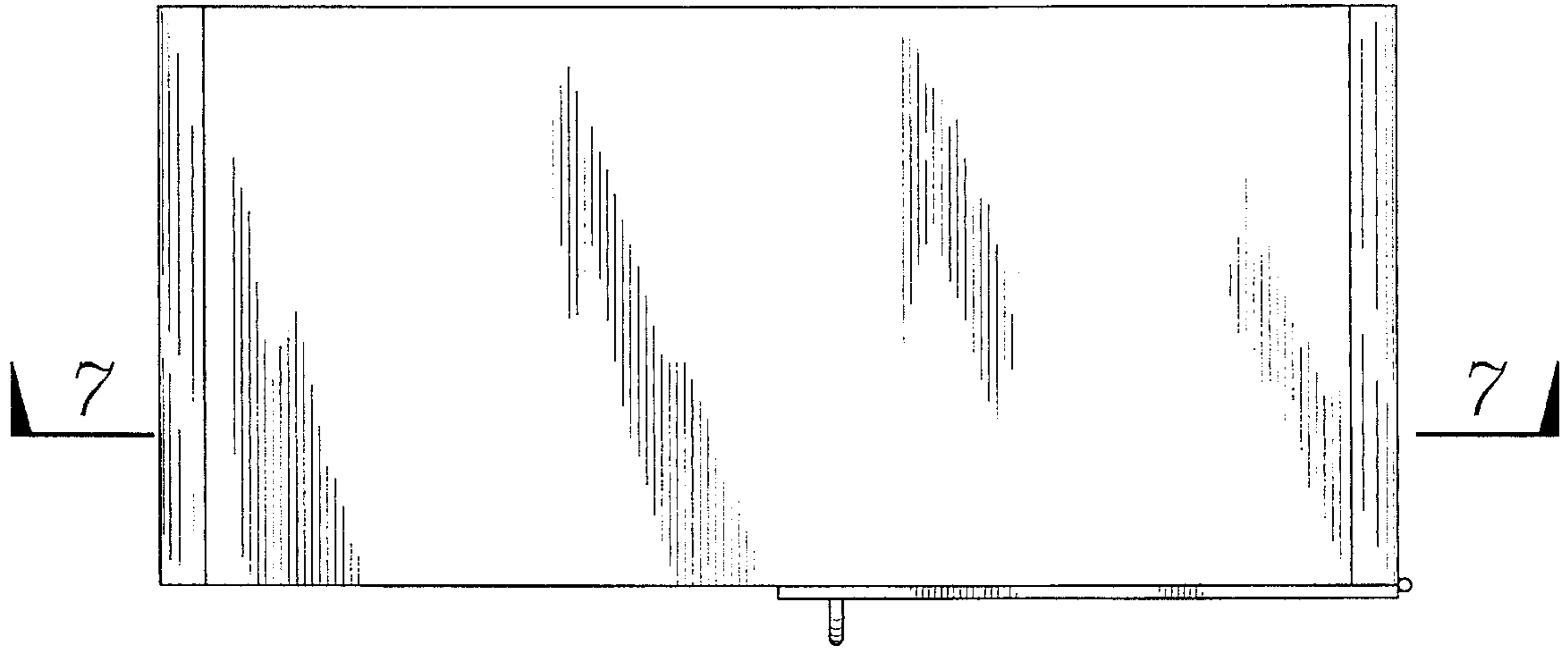

FIG. 6

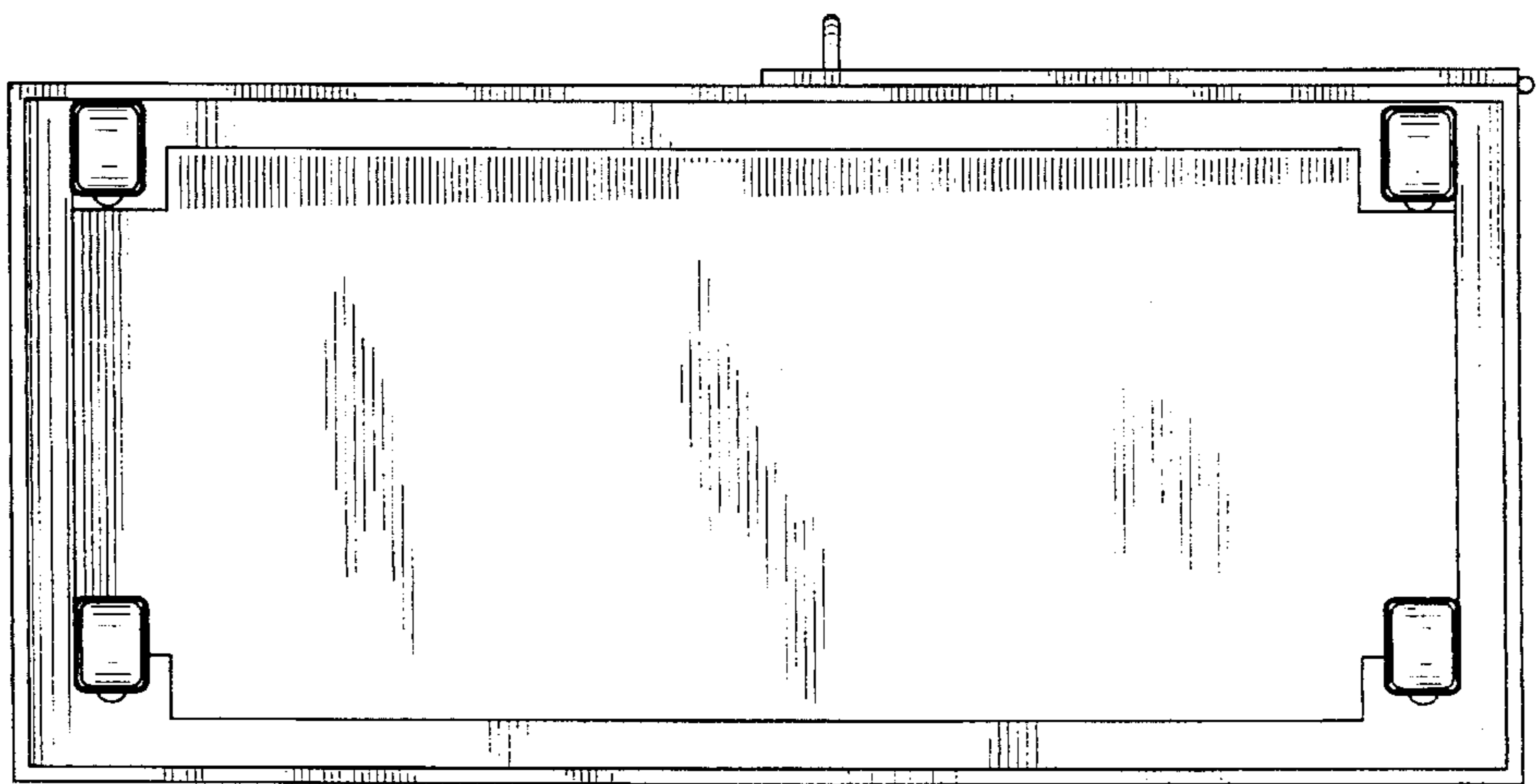

FIG. 7

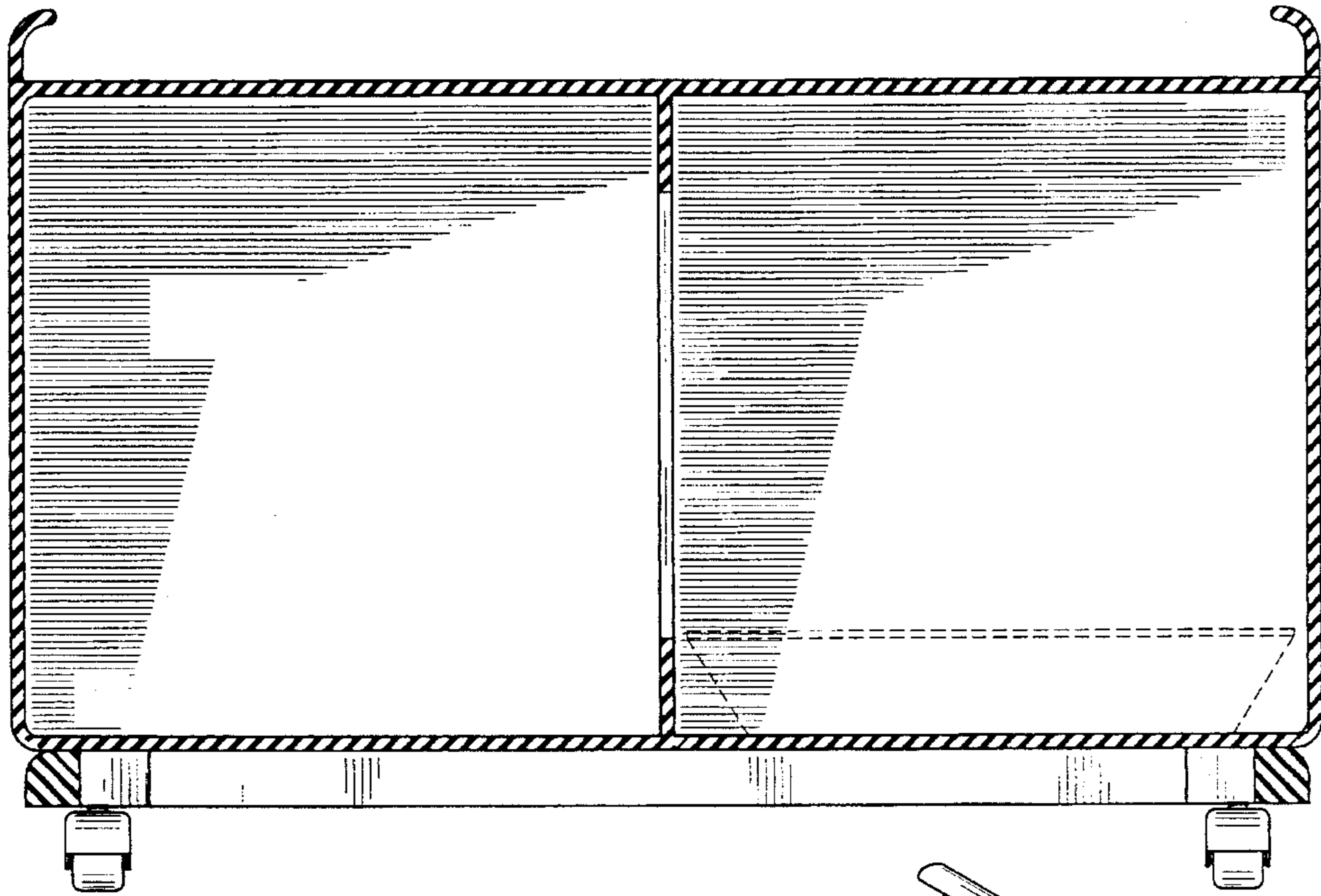

FIG. 8

