



US00D372801S

United States Patent [19]

[11] Patent Number: **Des. 372,801**

Fujimoto et al.

[45] Date of Patent: ***** Aug. 20, 1996**

[54] **MASSAGE CHAIR**

[75] Inventors: **Shinichiro Fujimoto; Yoshikiyo Yamasaki**, both of Osaka, Japan

[73] Assignee: **Kabushiki Kaisha Fuji Iryoki**, Osaka, Japan

[*] Notice: The portion of the term of this patent subsequent to Aug. 20, 2010, has been disclaimed.

[**] Term: **14 Years**

[21] Appl. No.: **38,462**

[22] Filed: **May 3, 1995**

[52] U.S. Cl. **D6/367**

[58] Field of Search D6/334, 335, 336, D6/360, 367, 371, 373, 375, 500, 501, 502; 297/411.2; 601/97-99, 102, 115, 116

[56] References Cited

U.S. PATENT DOCUMENTS

D. 123,275	10/1940	Popkin	D6/334
D. 227,209	6/1973	Fisher	D6/334
D. 235,395	6/1975	Fisher	D6/334
D. 240,479	7/1976	Halme	D6/334
D. 251,761	5/1979	Long	D6/334
D. 278,668	5/1985	Simpkins	D6/335
D. 336,167	6/1993	Yamasaki et al.	D6/367
D. 336,999	7/1993	Yamasaki et al.	D6/367
3,711,152	11/1973	Sirpak et al.	D6/367
5,417,644	5/1995	Lee	601/98

OTHER PUBLICATIONS

Hammacher Schlemmer, Mid-Summer 1993, p. 35, Massage Chair at bottom right.
Bloomingdale's, Sep. 24, 1994, p. 4, Barcalounger at top right.

Sharper Image, p. 39, massage chair at bottom right.

Primary Examiner—Gary D. Watson
Attorney, Agent, or Firm—Flynn, Thiel, Boutell & Tanis, P.C.

[57] CLAIM

The ornamental design for a massage chair, as shown and described.

DESCRIPTION

FIG. 1 is a front elevational view of a massage chair, showing our new design;
 FIG. 2 is a rear elevational view thereof;
 FIG. 3 is a top plan view thereof;
 FIG. 4 is a bottom plan view thereof;
 FIG. 5 is a right side elevational view thereof showing wires in broken lines;
 FIG. 6 is a left side elevational view thereof;
 FIG. 7 is a perspective view thereof;
 FIG. 8 is a front view showing the massage chair when the pillow is moved to the upper part;
 FIG. 9 is a front view showing the massage chair when the pillow is moved to the lower part;
 FIG. 10 is a left side elevational view showing the massage chair when the backrest is inclined rearward;
 FIG. 11 is a left side elevational view showing the massage chair when the footrest is extended;
 FIG. 12 is a left side elevational view showing the massage chair when the backrest is inclined rearward and the footrest is extended;
 FIG. 13 is a perspective view illustrating how an individual, shown in broken in lines, uses the massage chair; and,
 FIG. 14 is a left side elevational view illustrating how an individual, shown in broken lines, uses the massage chair.
 The broken line showings of the wires in FIG. 5, and the human form in FIGS. 13 and 14 are for environmental purposes only and form no part of the claimed design.

1 Claim, 7 Drawing Sheets

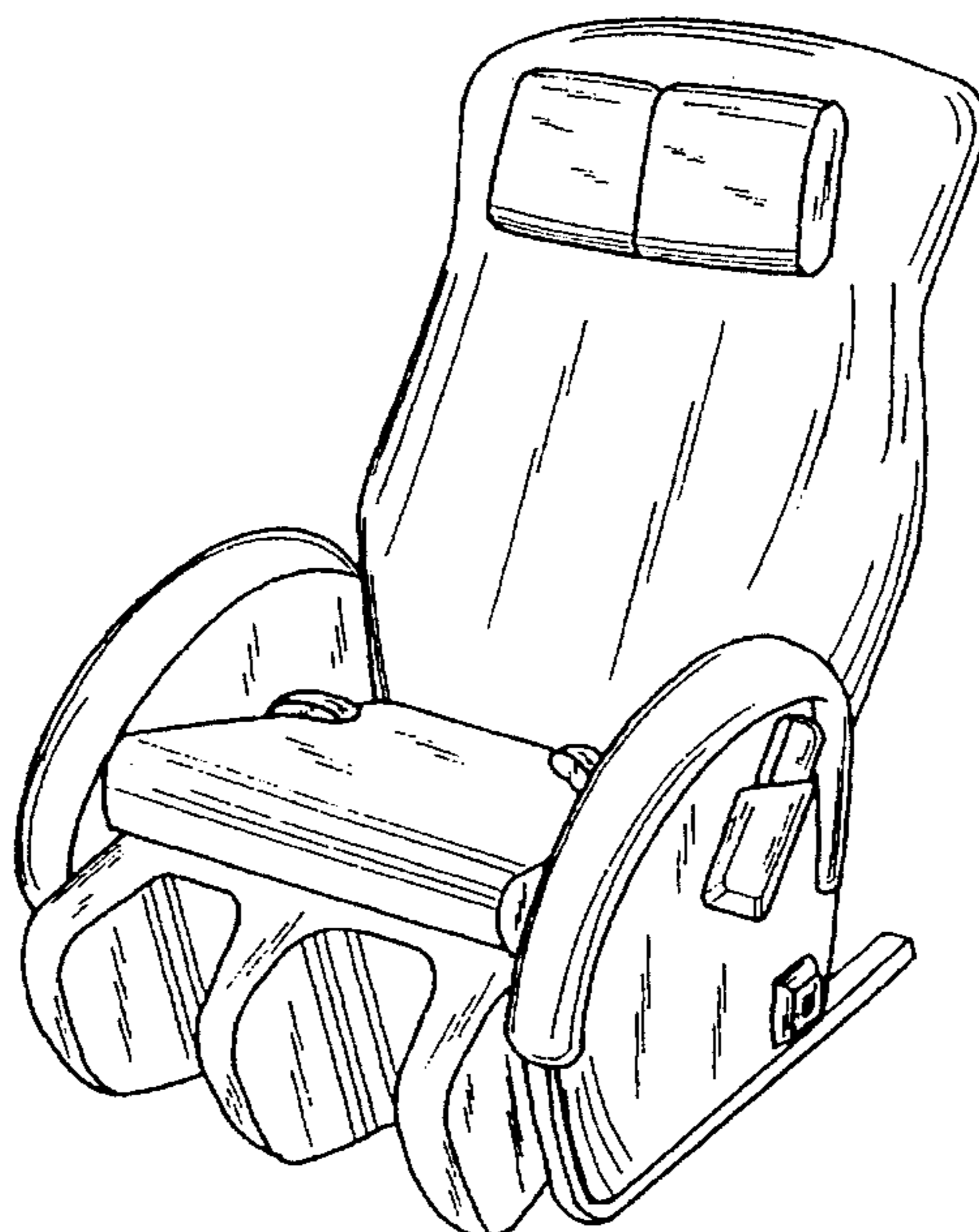

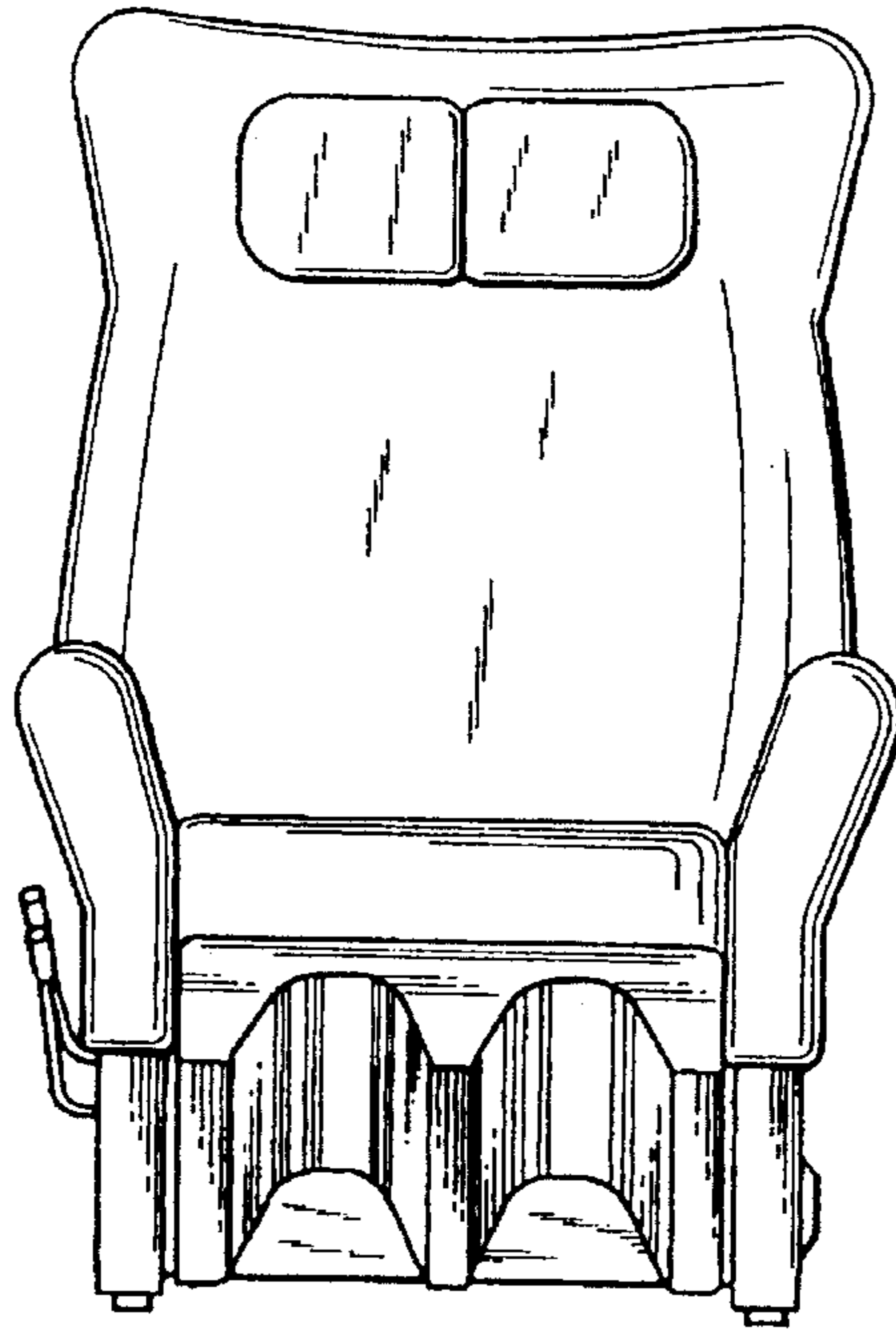

FIG. 1

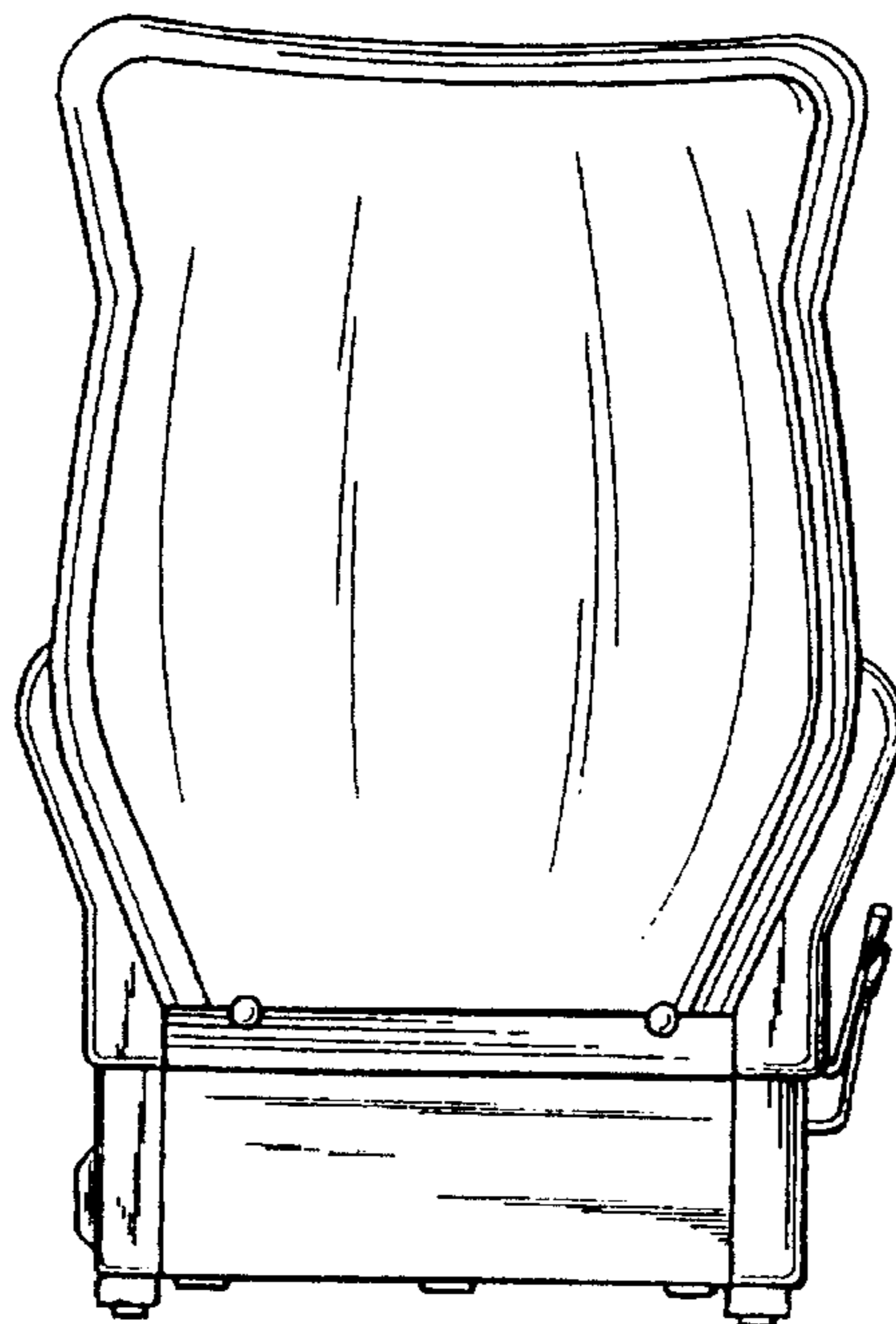

FIG. 2

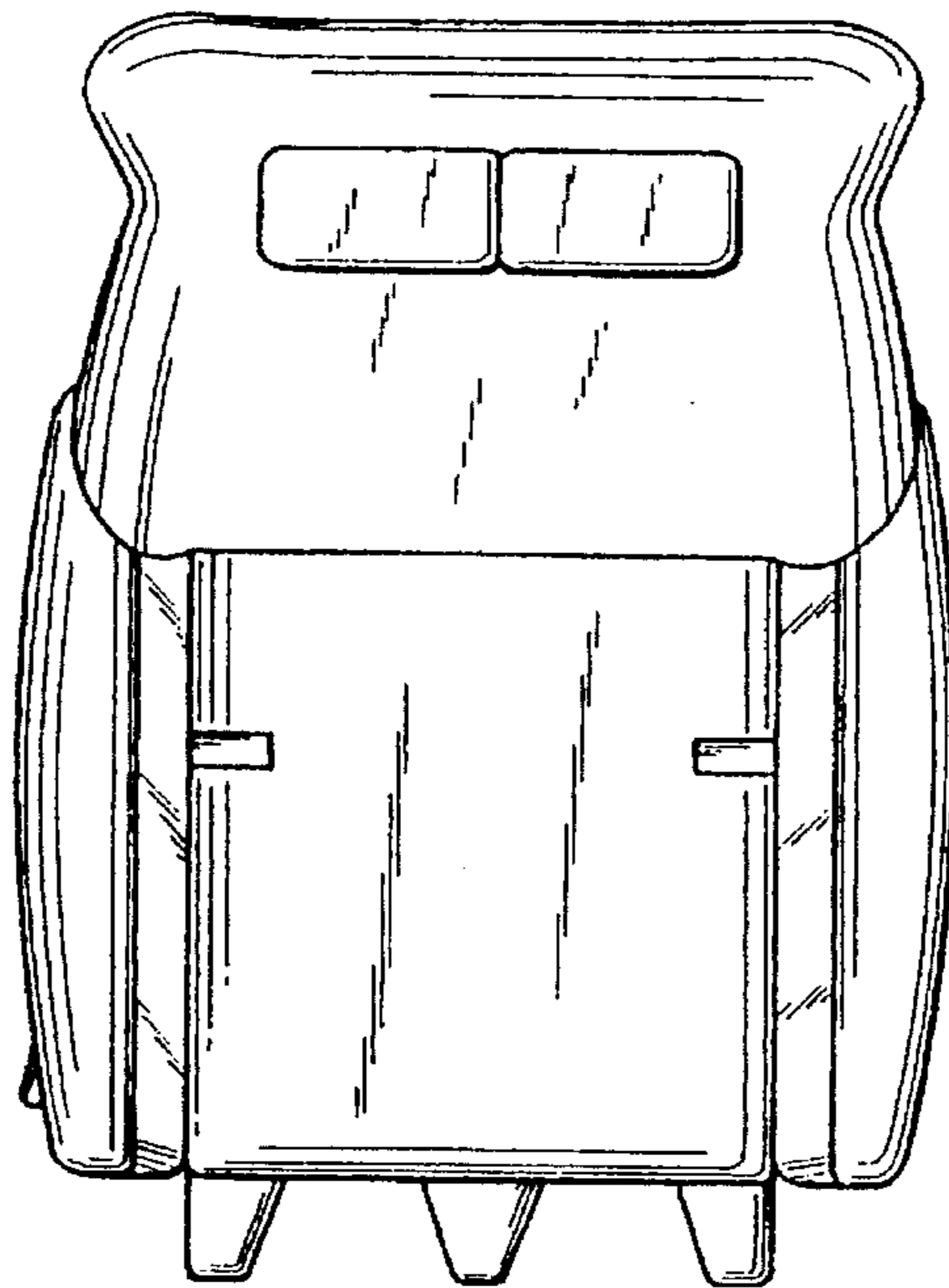

FIG. 3

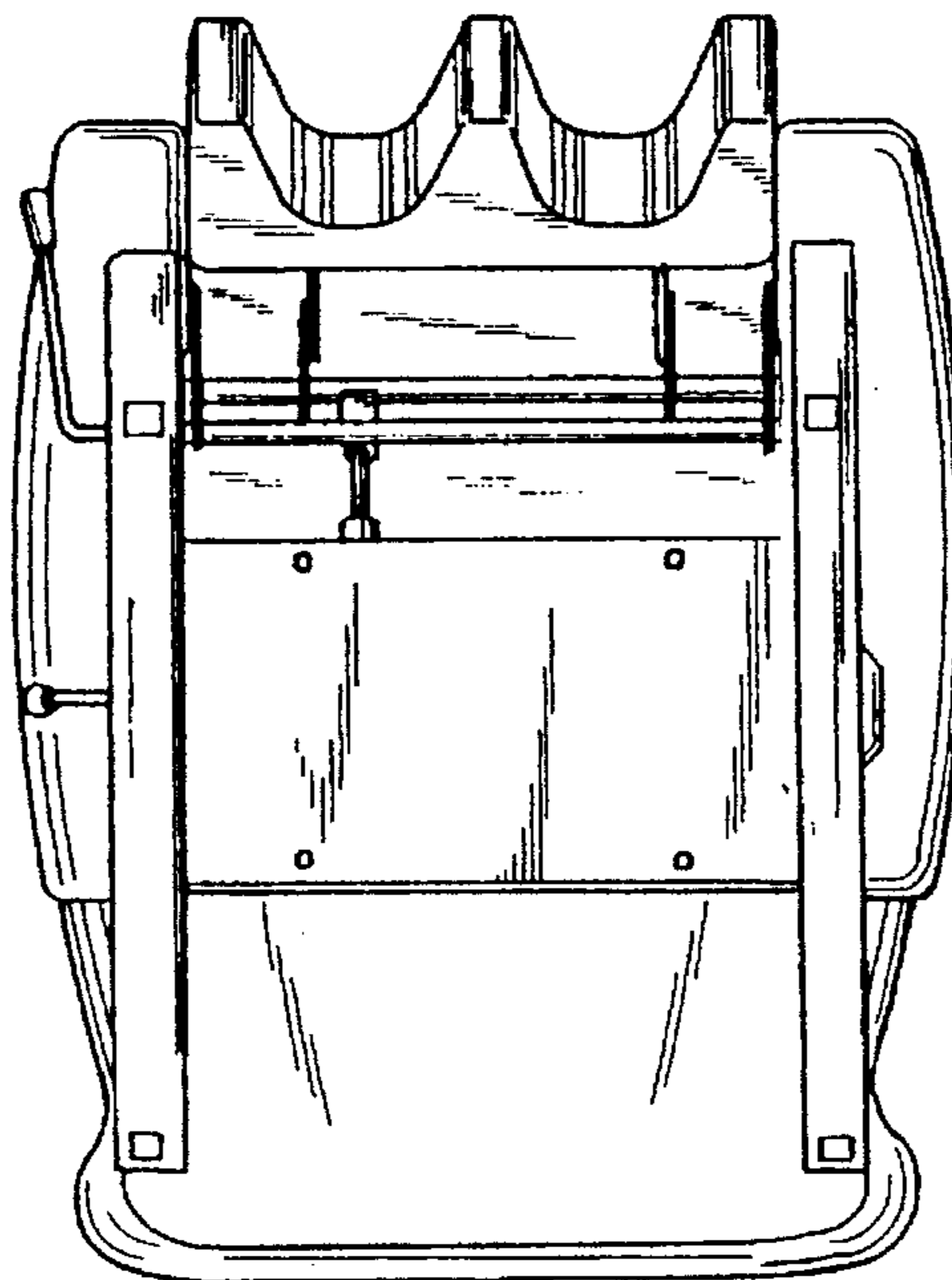

FIG. 4

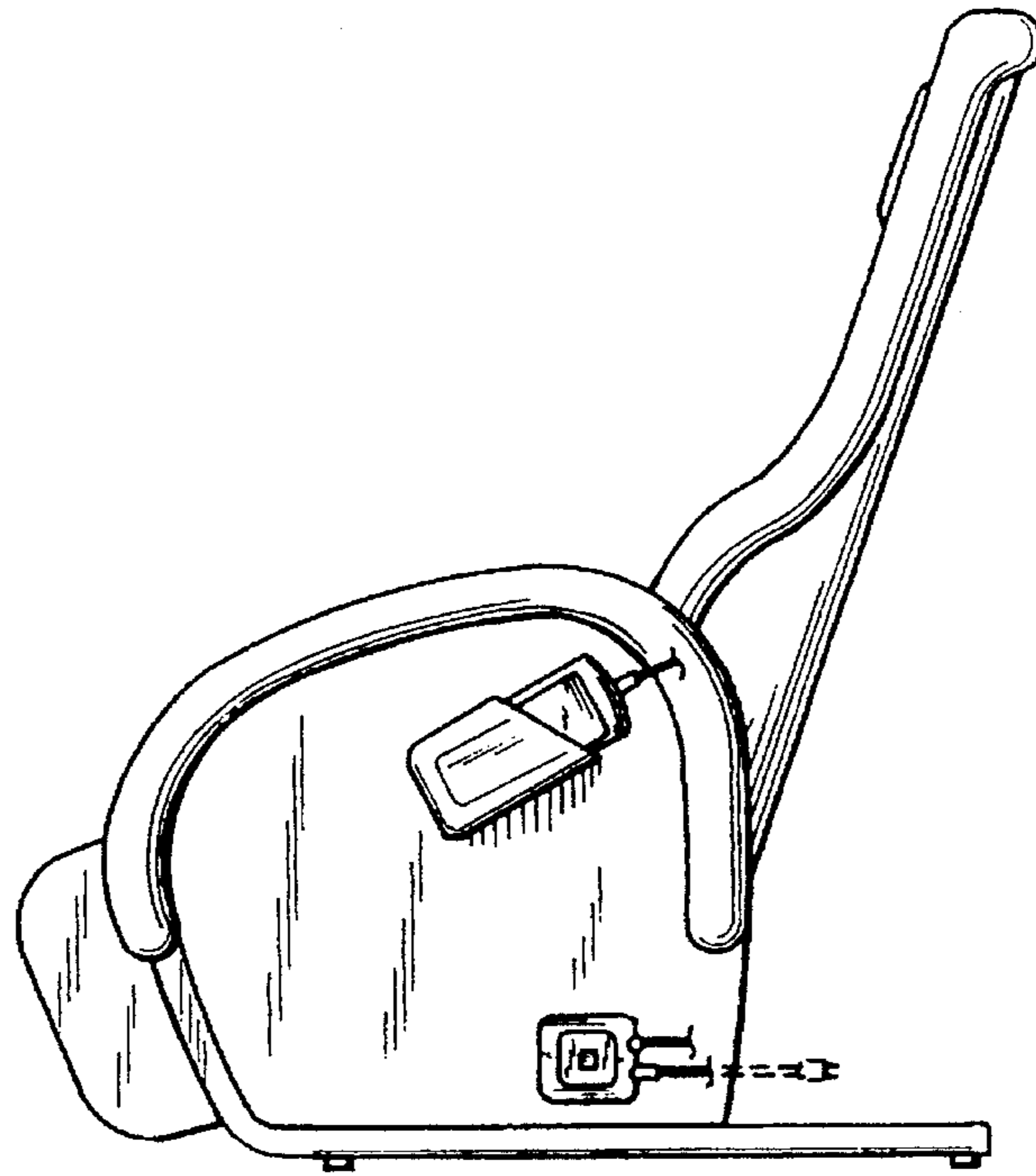

FIG. 5

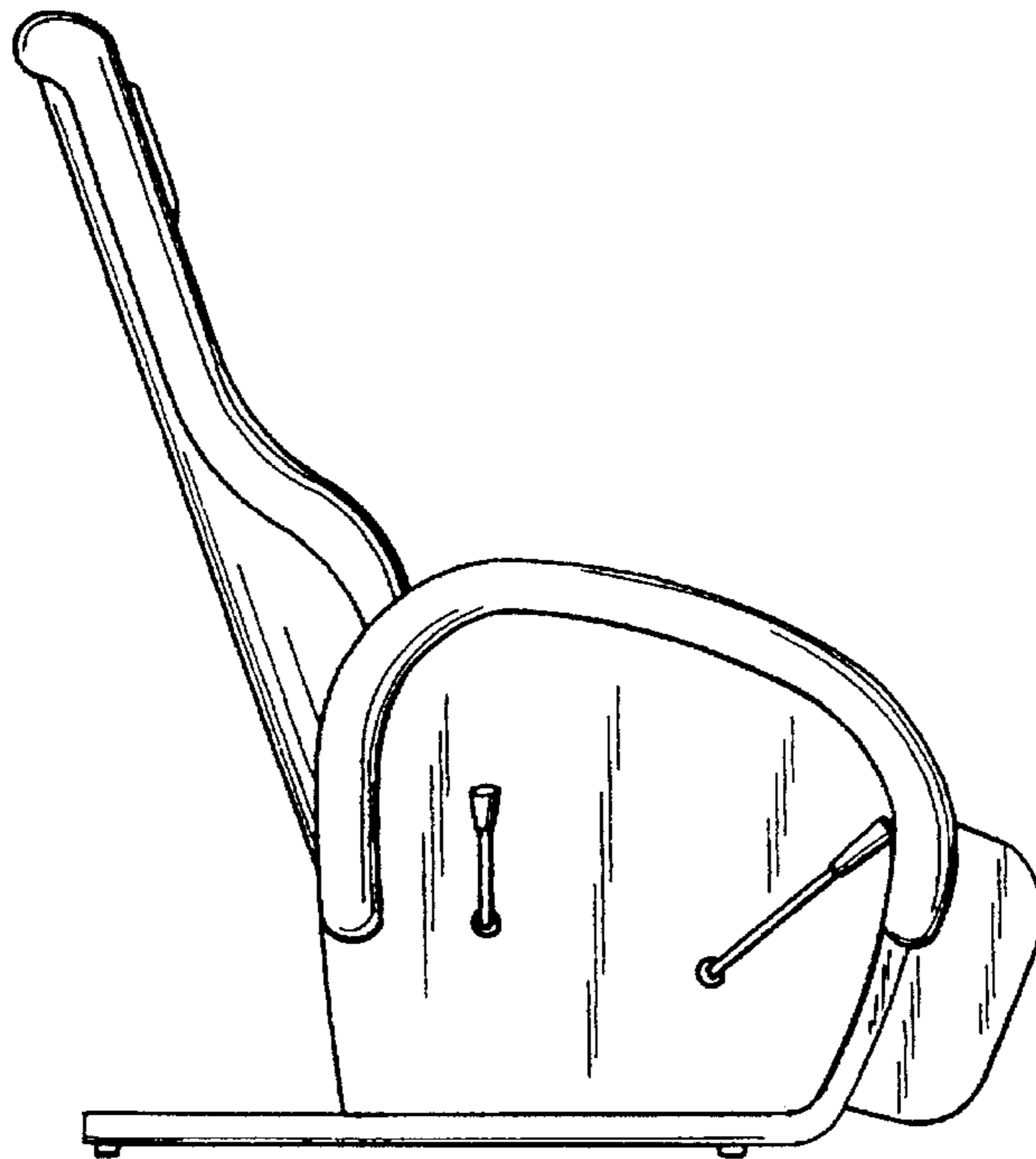

FIG. 6

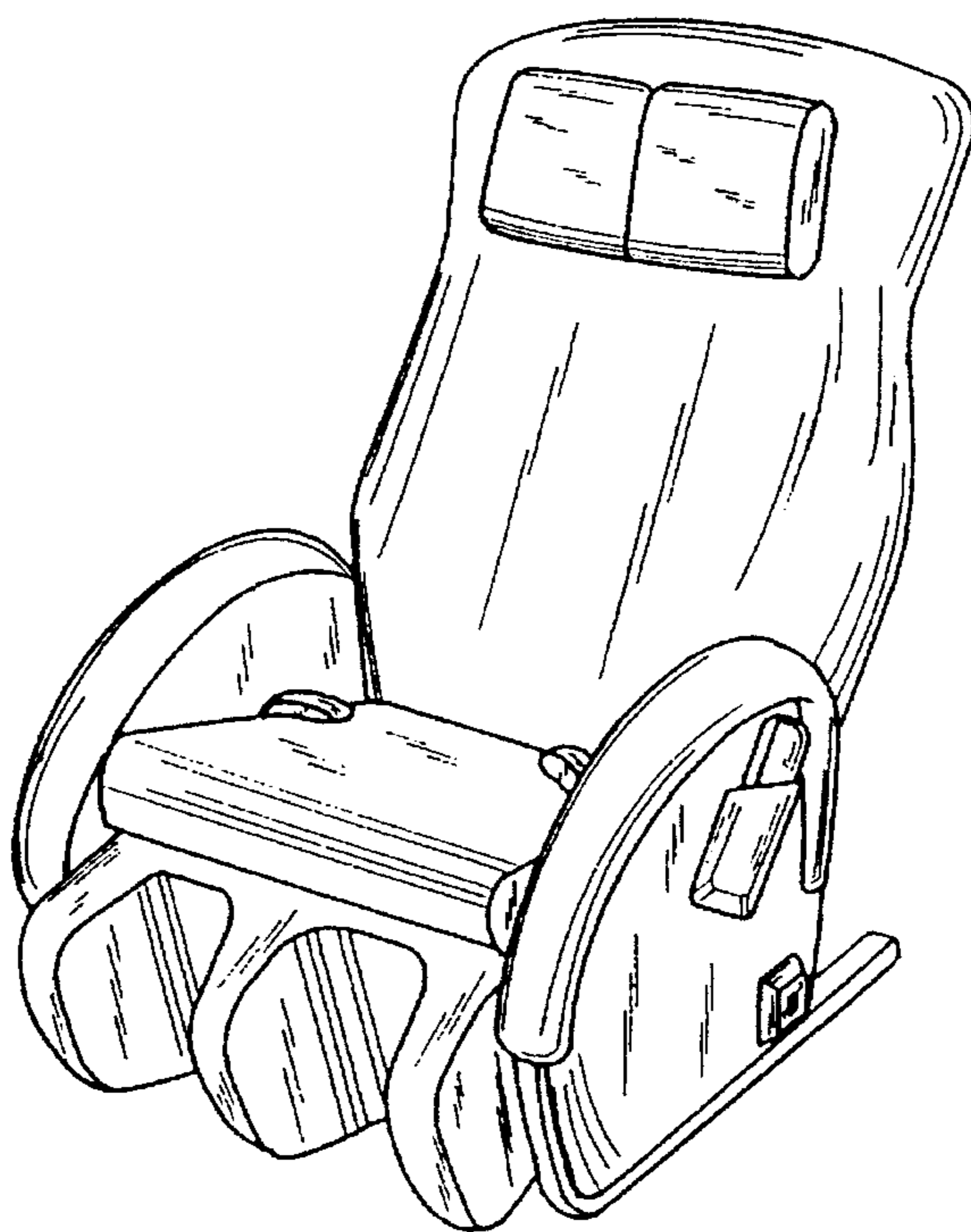

FIG. 7

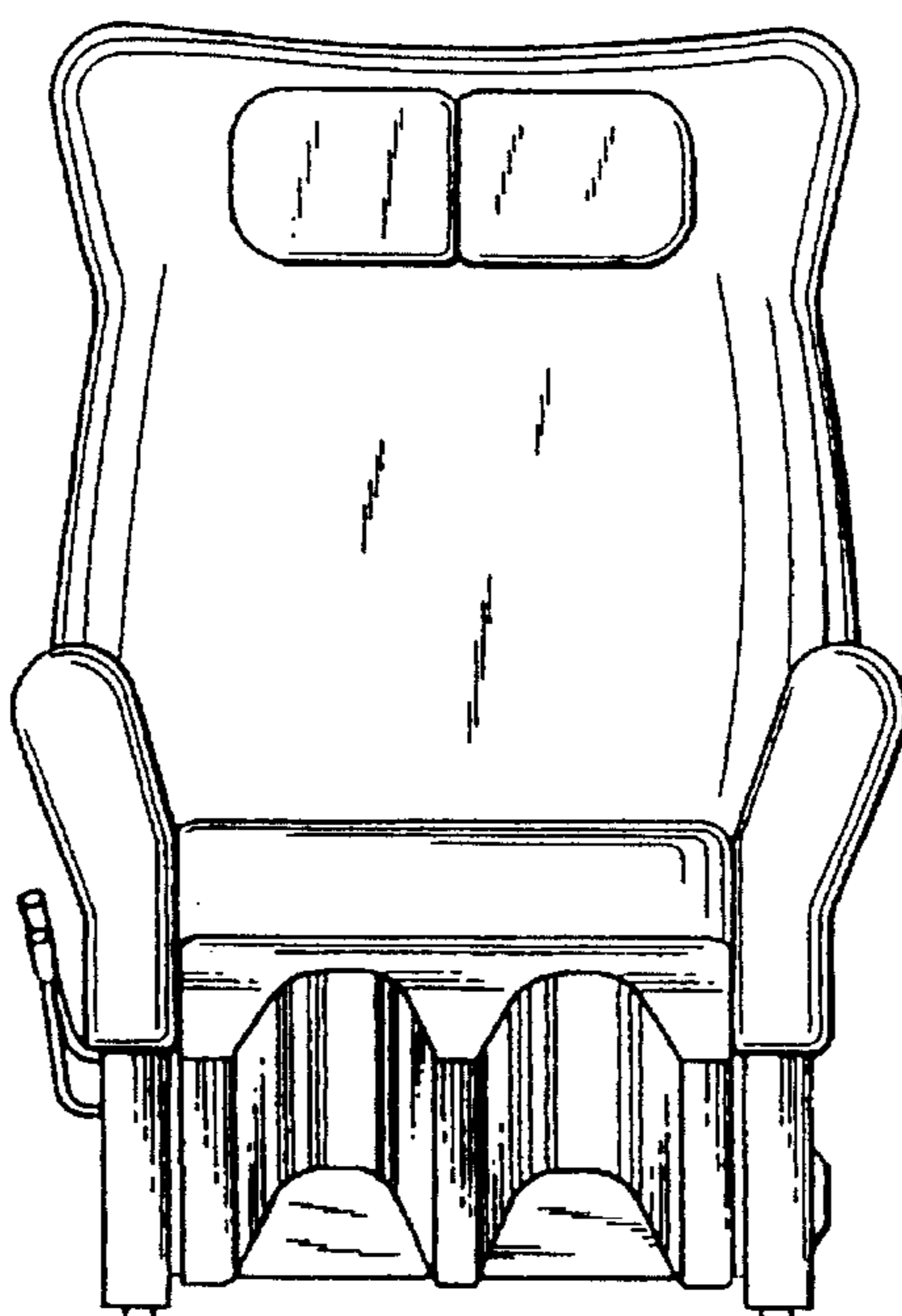

FIG. 8

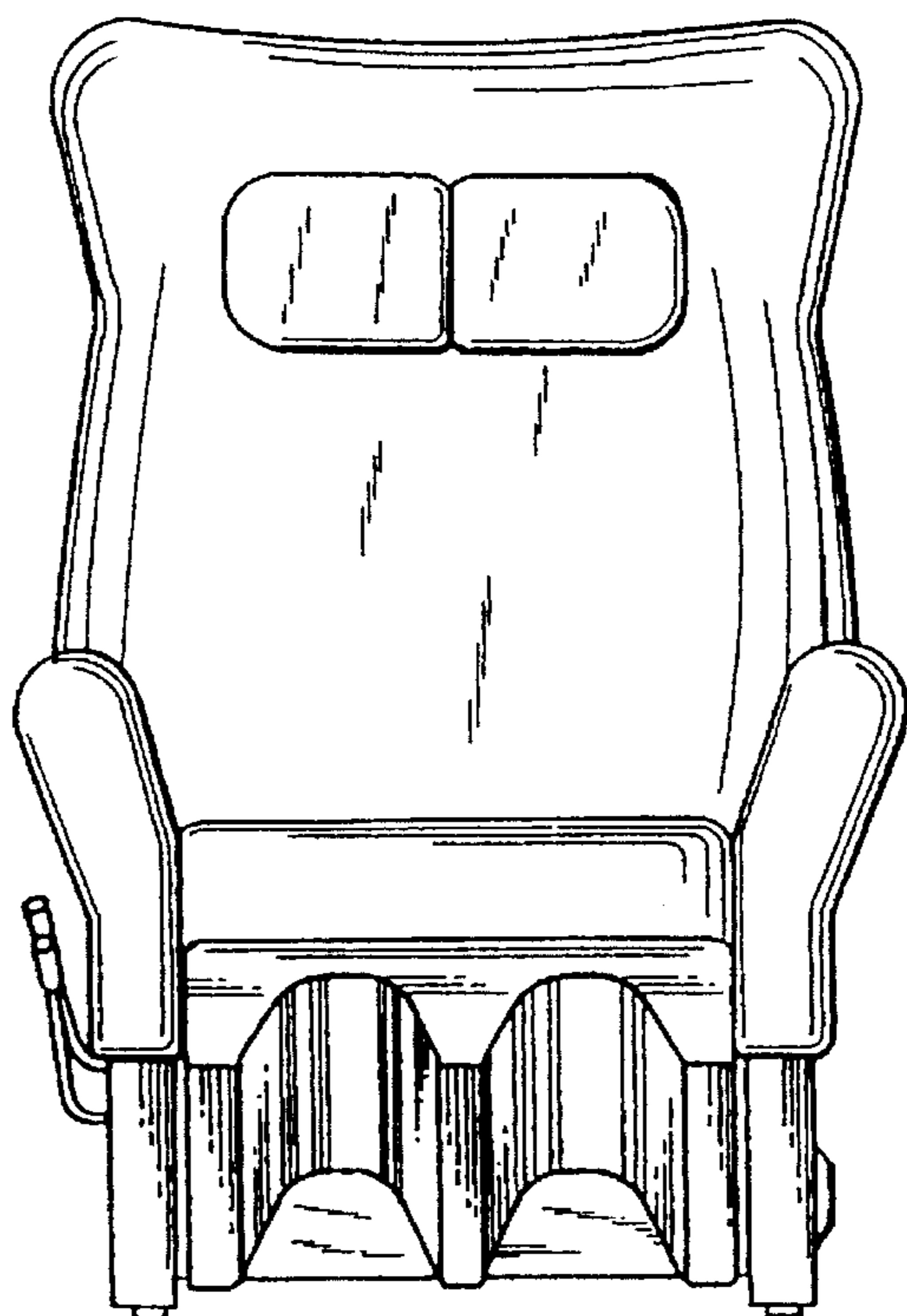

FIG. 9

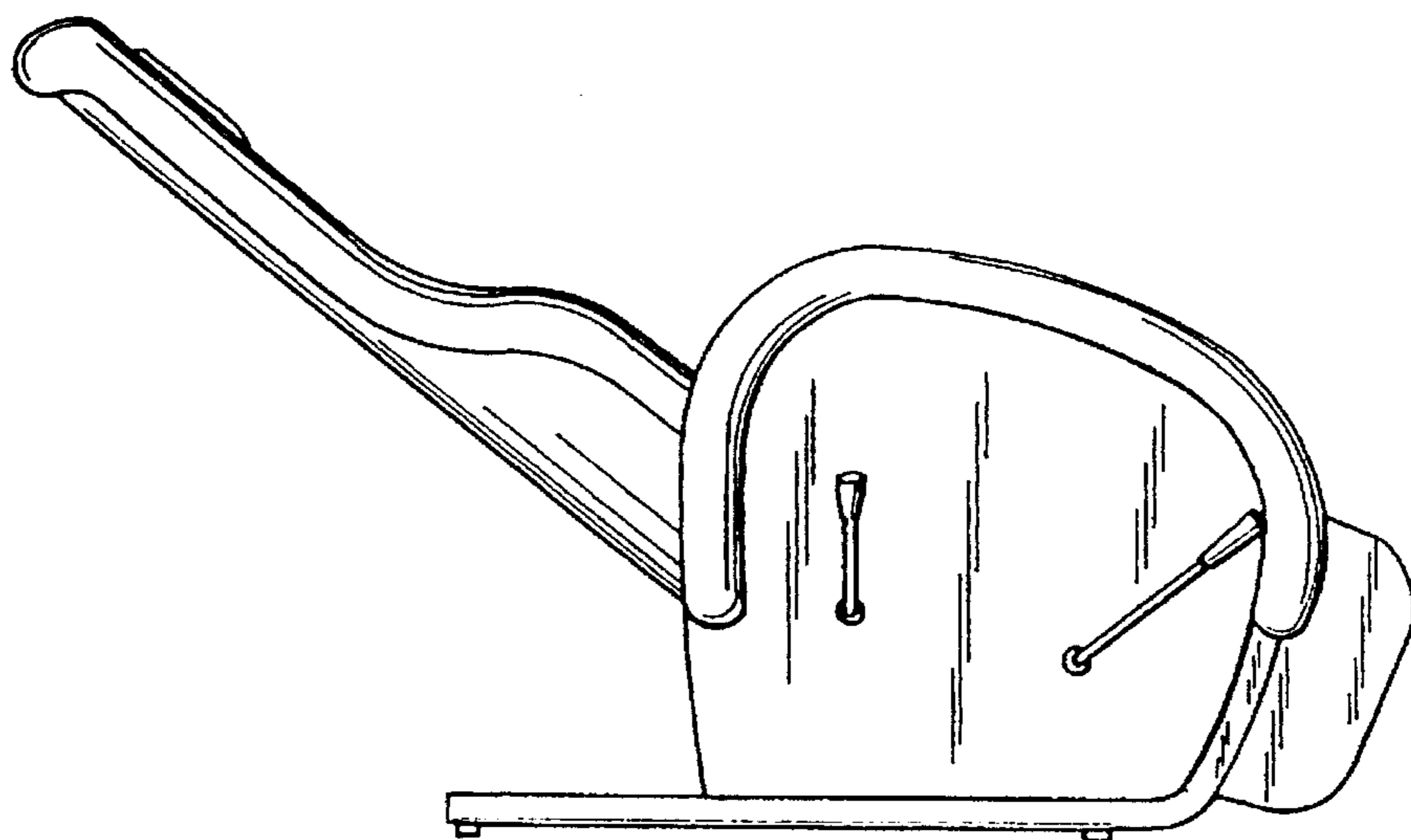

FIG. 10

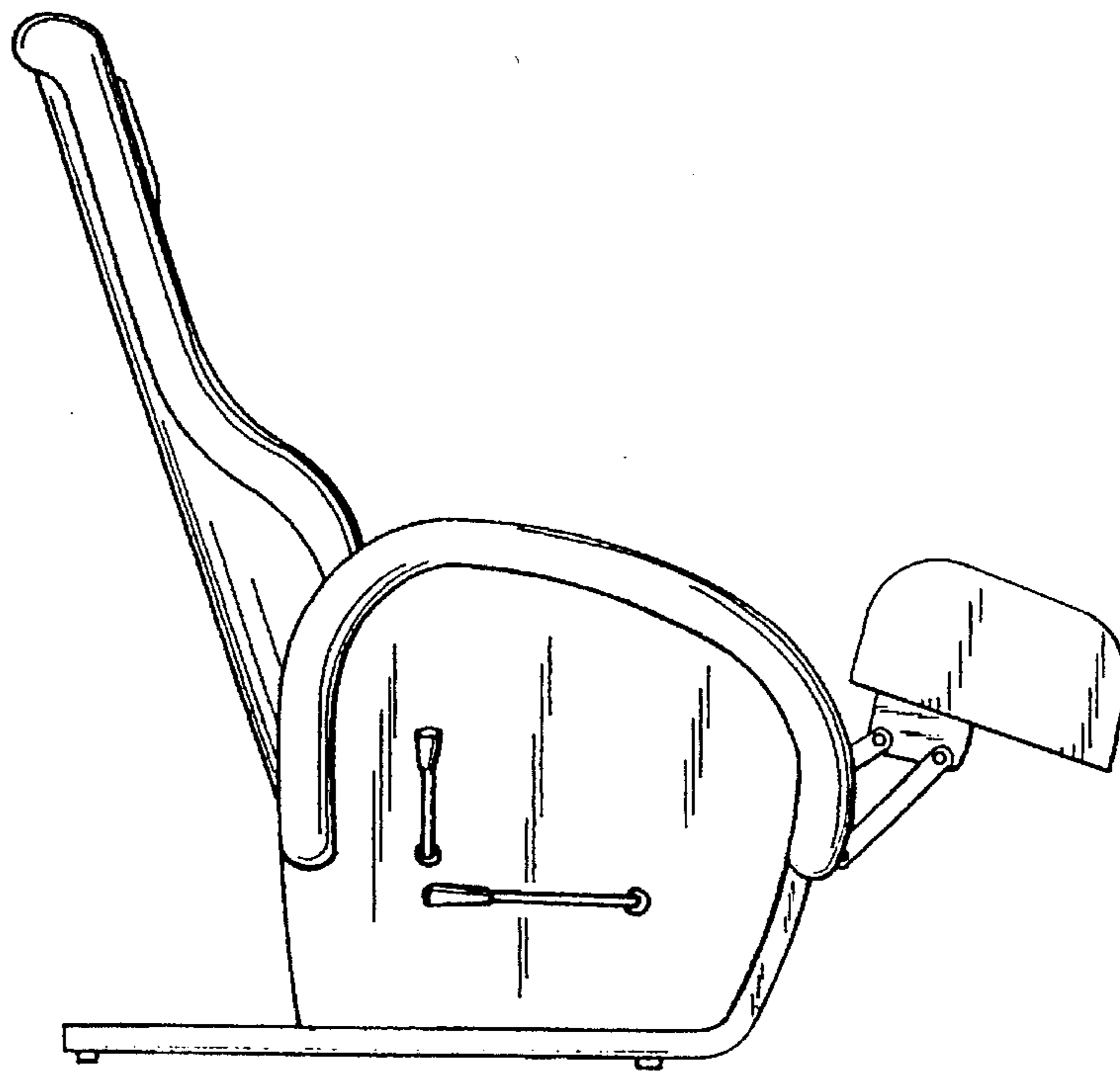

FIG. 11

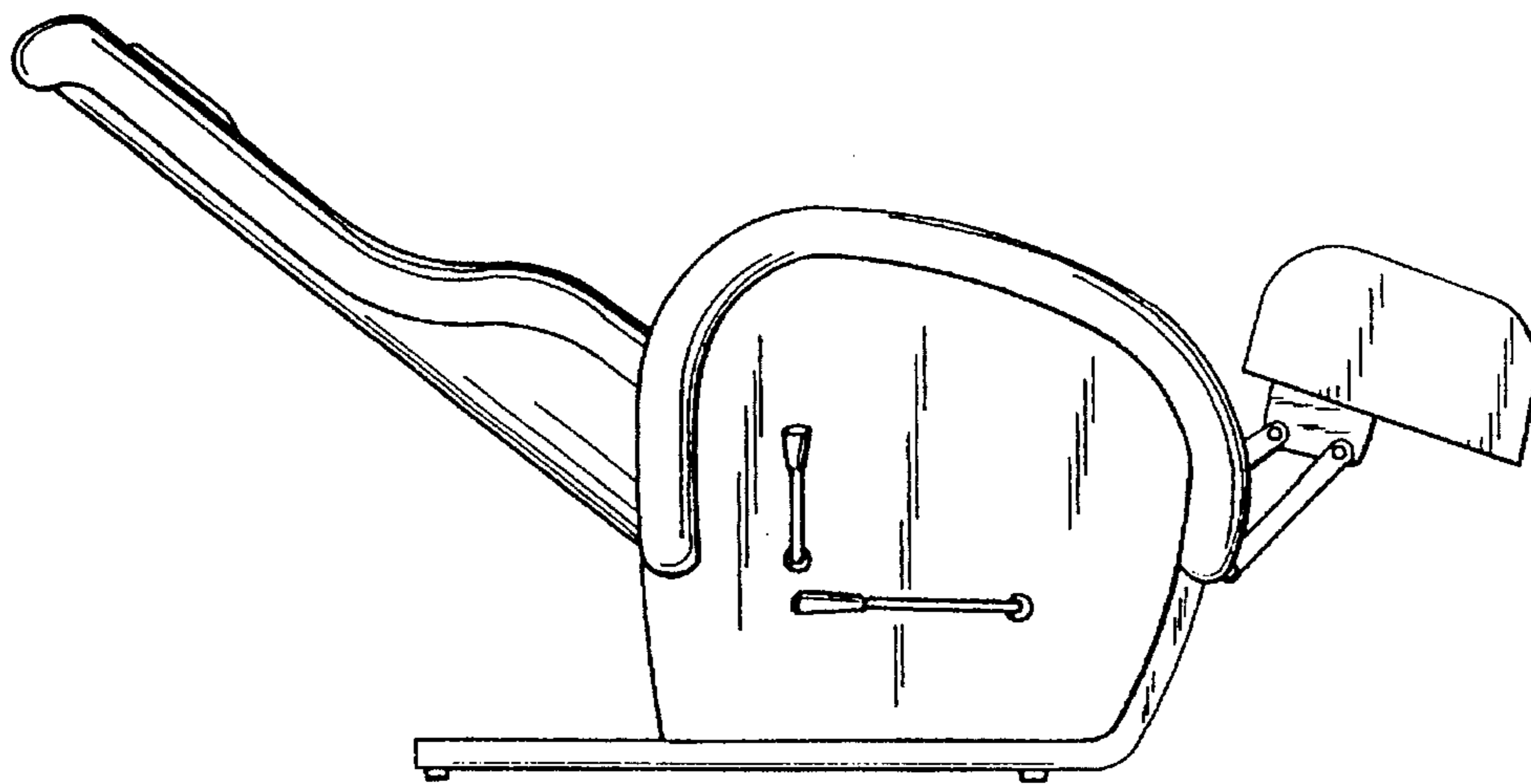

FIG. 12

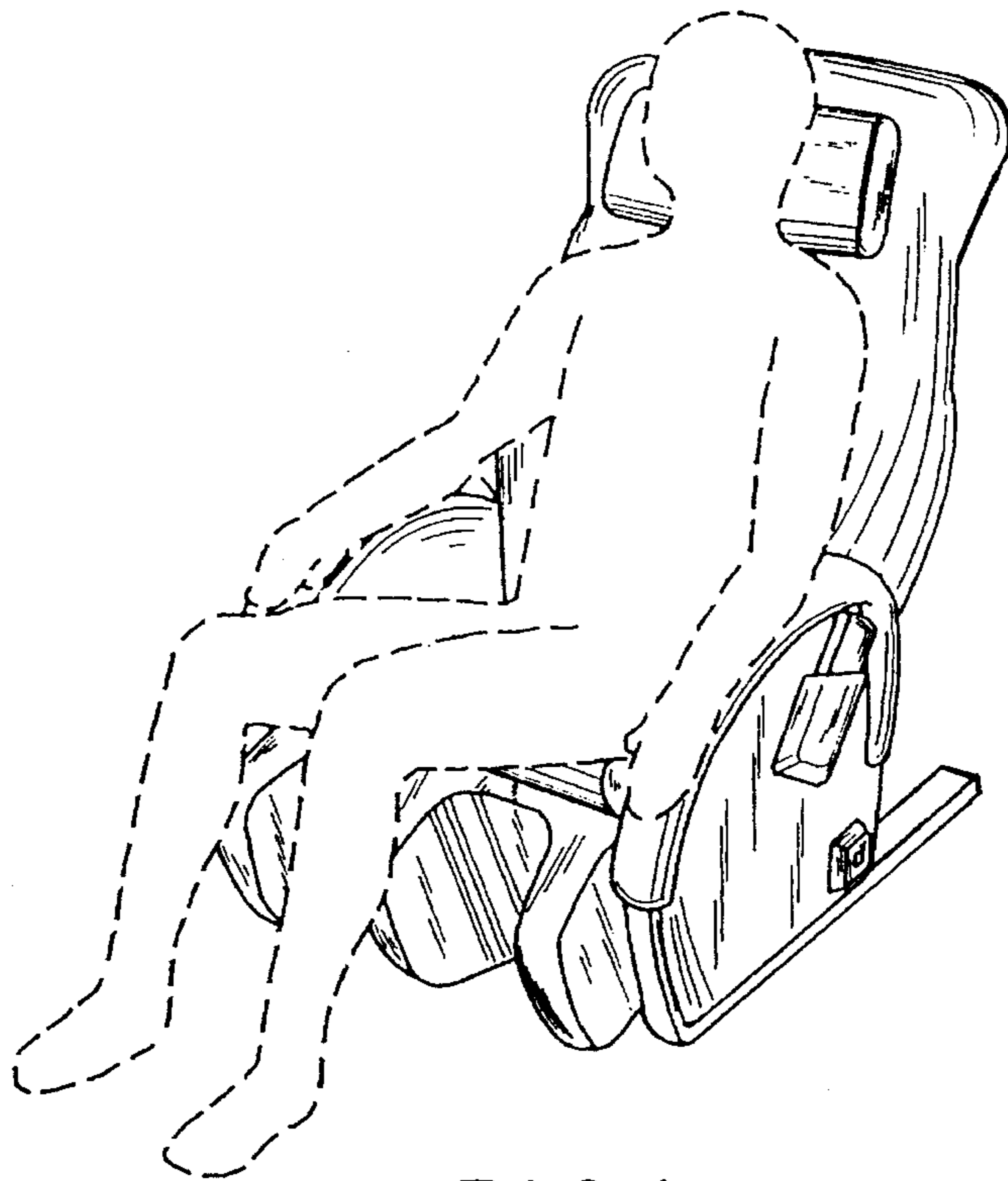

FIG. 13

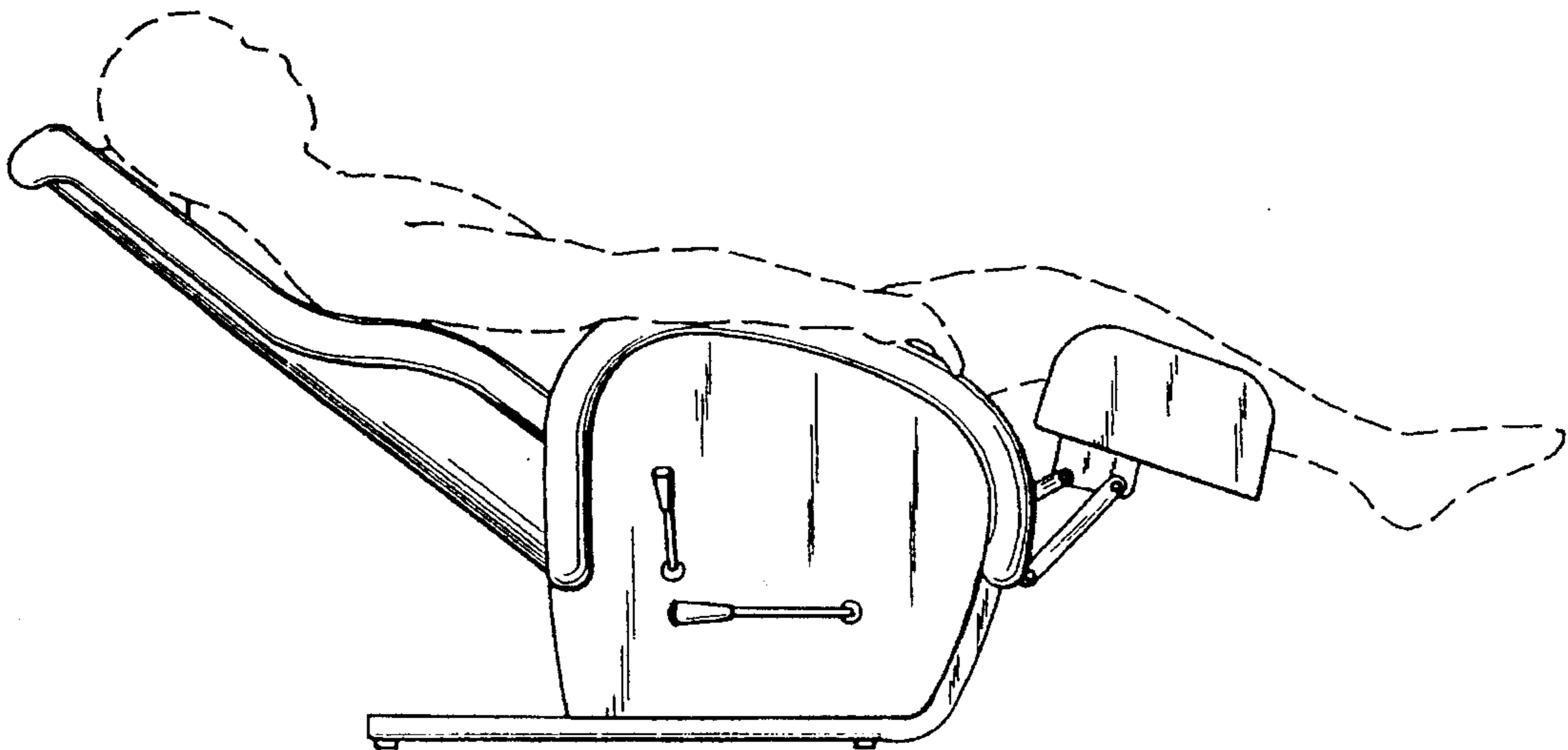

FIG. 14