



US00D372740S

United States Patent [19]

[11] Patent Number: Des. 372,740

Lerch et al.

[45] Date of Patent: **Aug. 13, 1996

[54] ARCADE GAME

[75] Inventors: Karl D. Lerch; Michael Clarke, both of East Aurora, N.Y.

[73] Assignee: Fisher-Price, Inc., East Aurora, N.Y.

[**] Term: 14 Years

[21] Appl. No.: 18,587

[22] Filed: Feb. 10, 1994

[52] U.S. Cl. D21/10

[58] Field of Search D21/7-10; 273/121 R 121 A, 273/121 E, 352, 118 R

[56] References Cited

U.S. PATENT DOCUMENTS

D. 242,557	11/1976	Lohr et al.	D21/10 X
D. 337,790	7/1993	Gottlieb et al.	D21/10
1,185,071	5/1916	Doeblich	273/352
1,221,803	4/1917	Johnston	273/352
2,806,701	9/1957	Durant	273/352
4,424,970	1/1984	Haliburton et al.	273/121 A
5,150,898	9/1992	Hochberg et al.	273/85 C
5,181,722	1/1993	Krutsch et al.	273/121 A X

OTHER PUBLICATIONS

Playmeter, Jul.-1981, p. 43.

Vending Times, Jan.-1979., Blue Note.

Vending Times, Feb.-1985, p. 63, Captain Hook.

Primary Examiner—Prabhakar G. Deshmukh

Attorney, Agent, or Firm—C. Scott Talbot; Howrey & Simon

[57] CLAIM

The ornamental design for the arcade game, as shown and described.

DESCRIPTION

FIG. 1 is a right side elevational view of an arcade game showing our new design; with the basketball backboard support post disposed in a play position and the basketball return net deployed.

FIG. 2 is a left side elevational view thereof;

FIG. 3 is a front elevational view thereof;

FIG. 4 is a rear elevational view thereof;

FIG. 5 is a top plan view thereof;

FIG. 6 is a right side elevational view thereof; with the backboard support post disposed in a stowed position for clarity of illustration;

FIG. 7 is a left side elevational view of FIG. 6;

FIG. 8 is a front elevational view of FIG. 6;

FIG. 9 is a rear elevational view of FIG. 6;

FIG. 10 is a bottom plan view of FIG. 6;

FIG. 11 is a front elevational view thereof; with the backboard support post disposed in a stowed position and a cover removed to expose a target bowling scoring apparatus for clarity of illustration;

FIG. 12 is a top plan view of FIG. 11;

FIG. 13 is a top plan view thereof; with the backboard support post disposed in a stowed position and a cover removed to expose a pinball scoring apparatus for clarity of illustration;

FIG. 14 is a perspective view of a second embodiment of the arcade game with the basketball support post disposed in a play position and the basketball return net deployed;

FIG. 15 is a right side elevational view of FIG. 14;

FIG. 16 is a left side elevational view of FIG. 14;

FIG. 17 is a front elevational view of FIG. 14;

FIG. 18 is a rear elevational view of FIG. 14;

FIG. 19 is a top plan view of FIG. 14;

FIG. 20 is a perspective view of the second embodiment of the arcade game; with the basketball backboard support post disposed in a play position and the basketball return net removed for clarity of illustration;

FIG. 21 is a perspective view of the second embodiment of the arcade game with the backboard support post disposed in a stowed position;

FIG. 22 is a left side elevational view of FIG. 21;

FIG. 23 is a right side elevational view of FIG. 21;

FIG. 24 is a front elevational view of FIG. 21;

FIG. 25 is a rear elevational view of FIG. 21;

FIG. 26 is a bottom plan view of FIG. 21;

FIG. 27 is a perspective view of the second embodiment of the arcade game; with the backboard support post disposed in a stowed position and a cover removed to expose a target bowling scoring apparatus for clarity of illustration;

FIG. 28 is a front elevational view of FIG. 27;

FIG. 29 is a top plan view of FIG. 27;

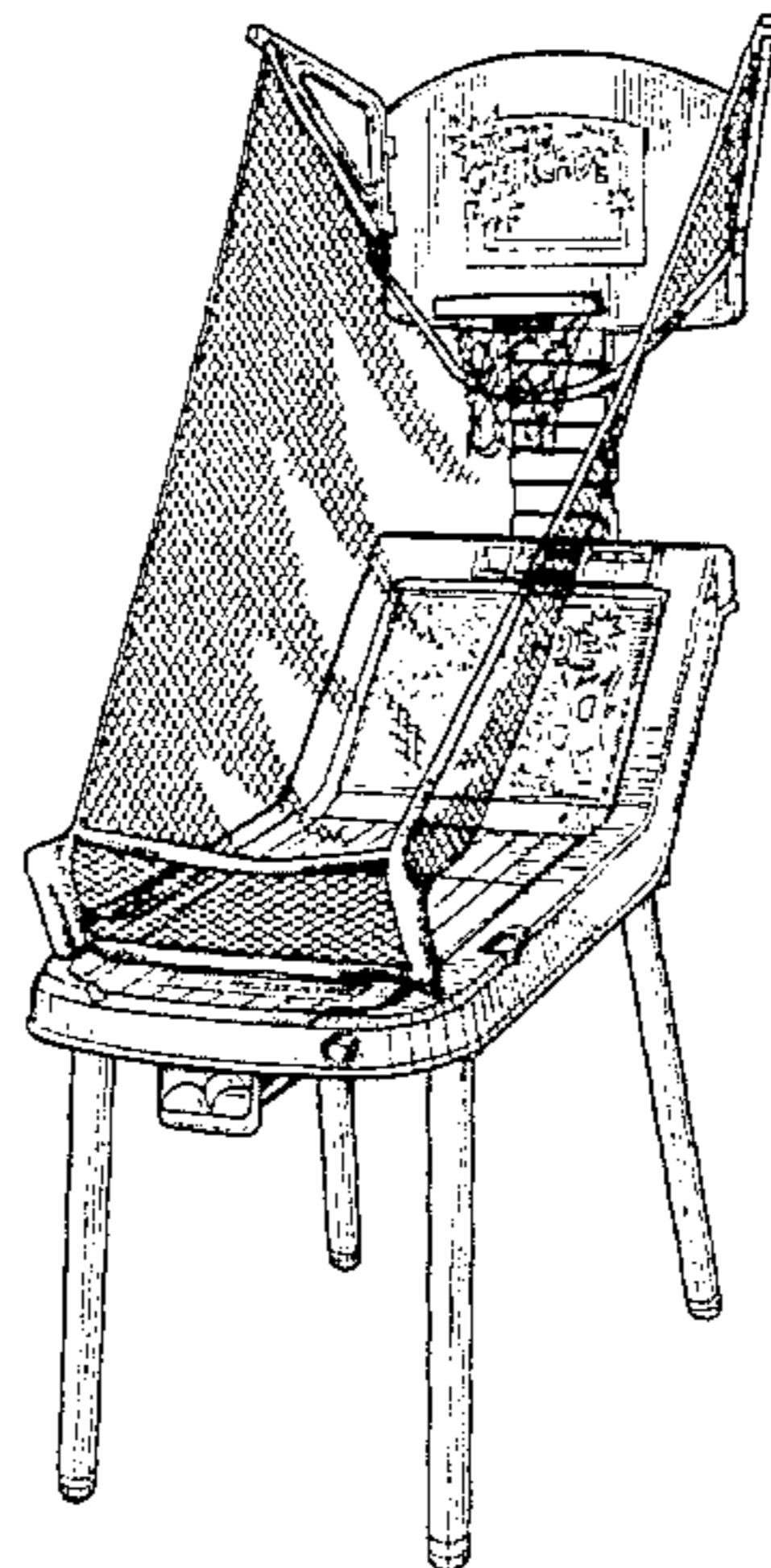

FIG. 30 is a perspective view of the second embodiment of the arcade game with the backboard support post disposed in a stowed position and a cover removed to expose a pinball apparatus for clarity of illustration;

FIG. 31 is a top plan view of FIG. 30;

FIG. 32 is a perspective view of a third embodiment of the arcade game;

FIG. 33 is a right side elevational view of FIG. 32;

FIG. 34 is a left side elevational view of FIG. 32;

FIG. 35 is a front elevational view of FIG. 32;

FIG. 36 is a rear elevational view of FIG. 32;

FIG. 37 is a top plan view of FIG. 32; and,

FIG. 38 is a bottom plan view of FIG. 32.

1 Claim, 38 Drawing Sheets

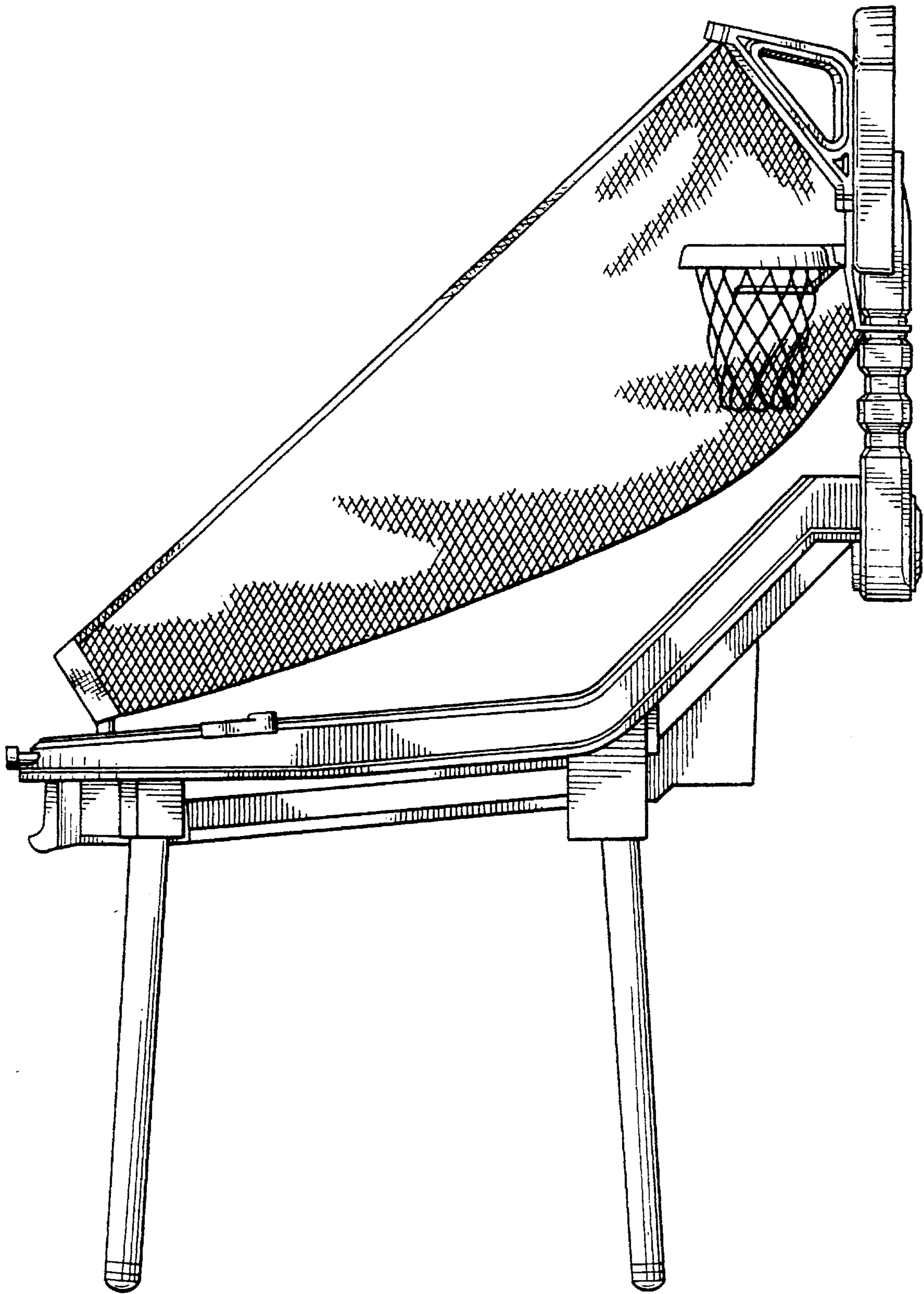

FIG. 1

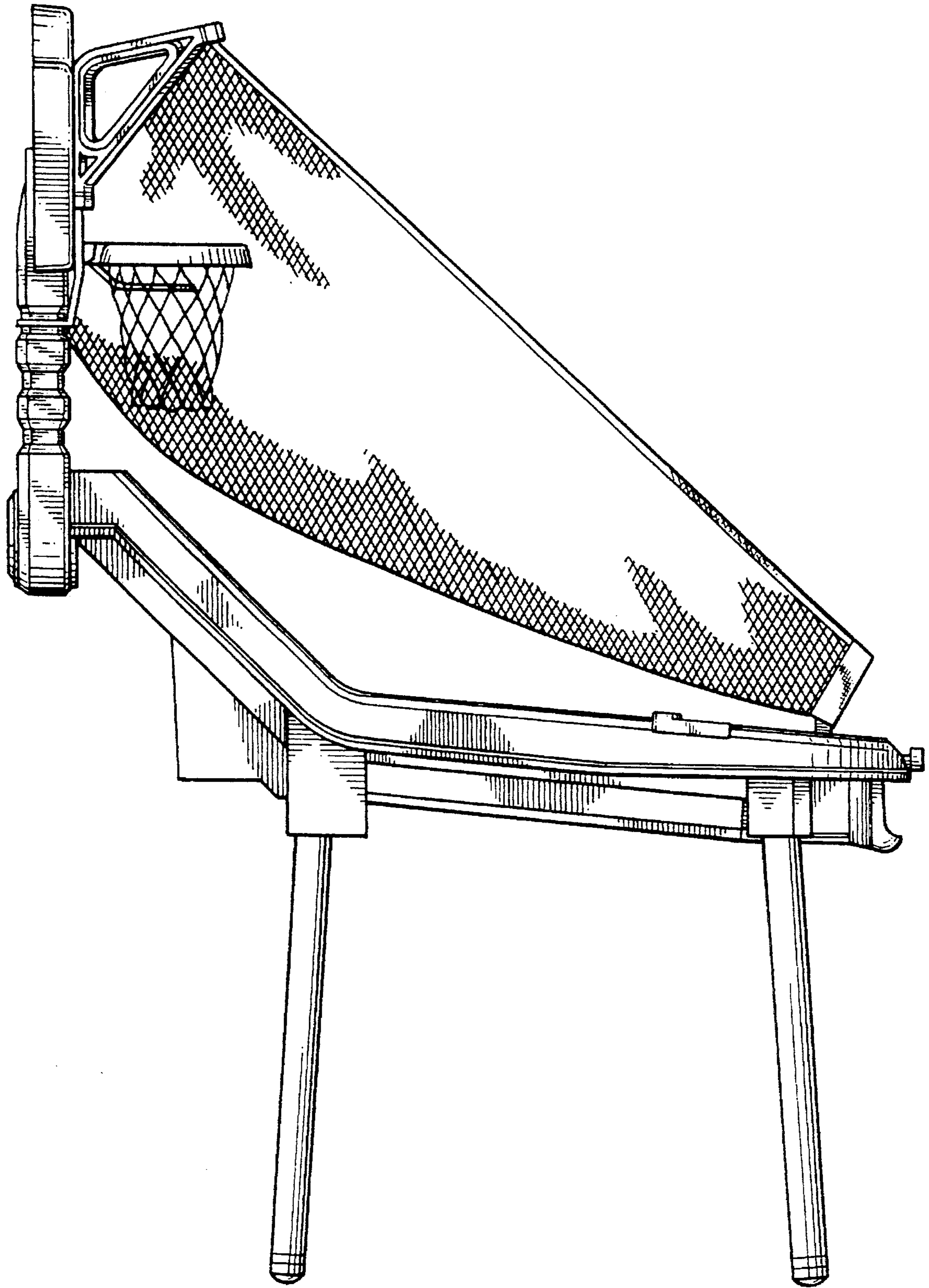

FIG. 2

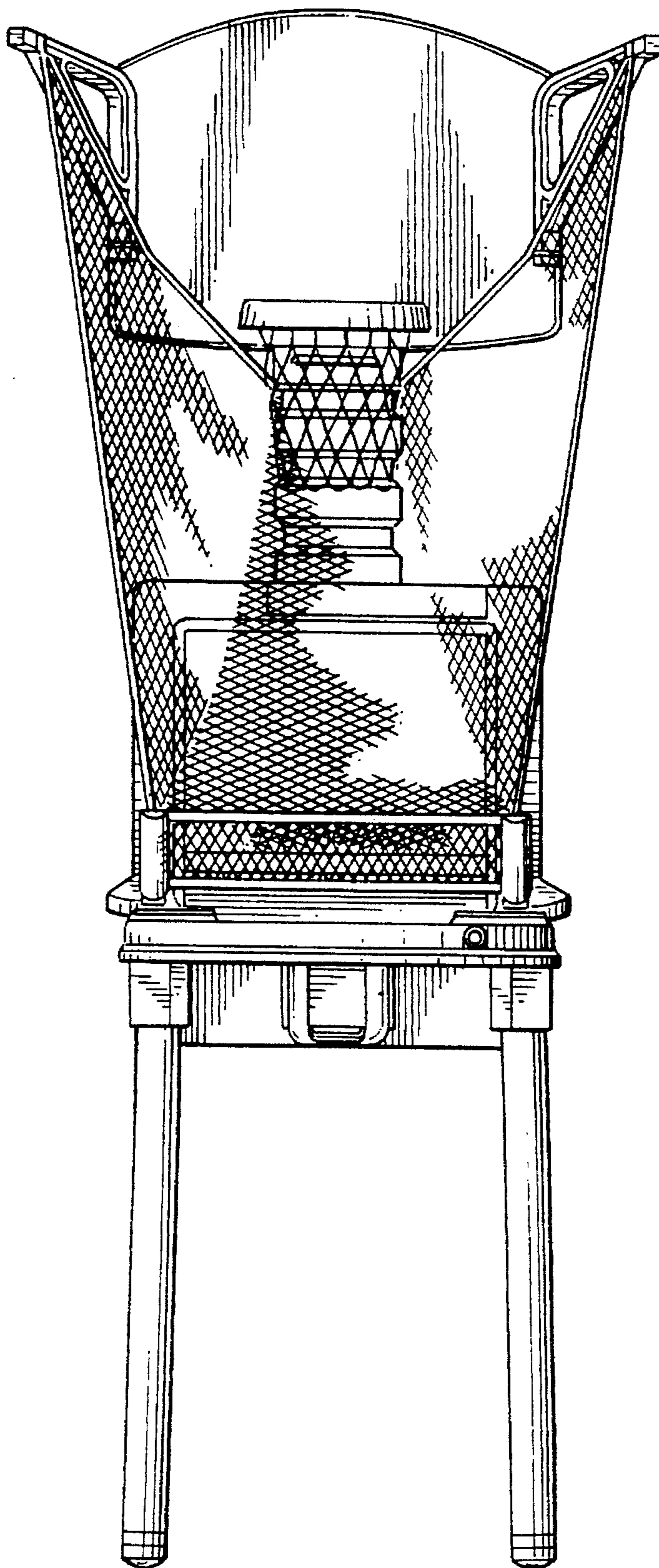

FIG. 3

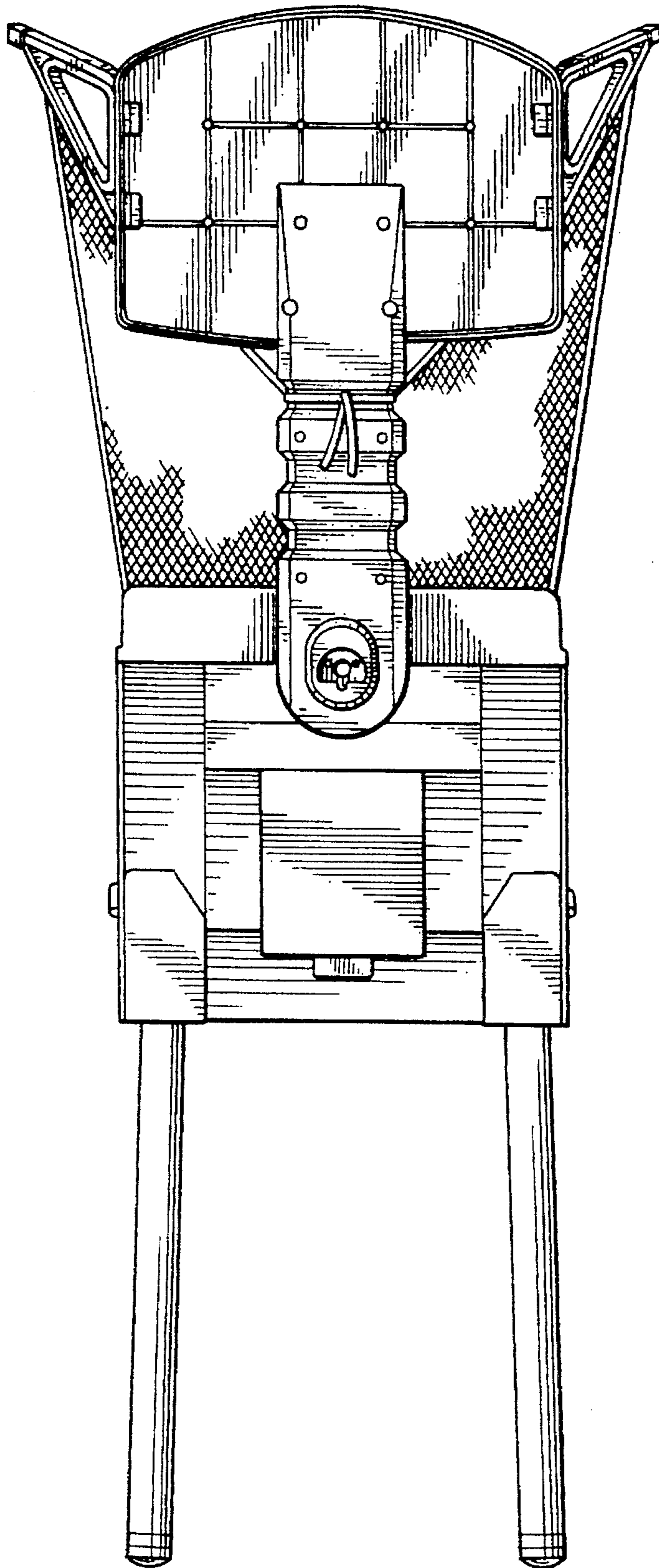

FIG. 4

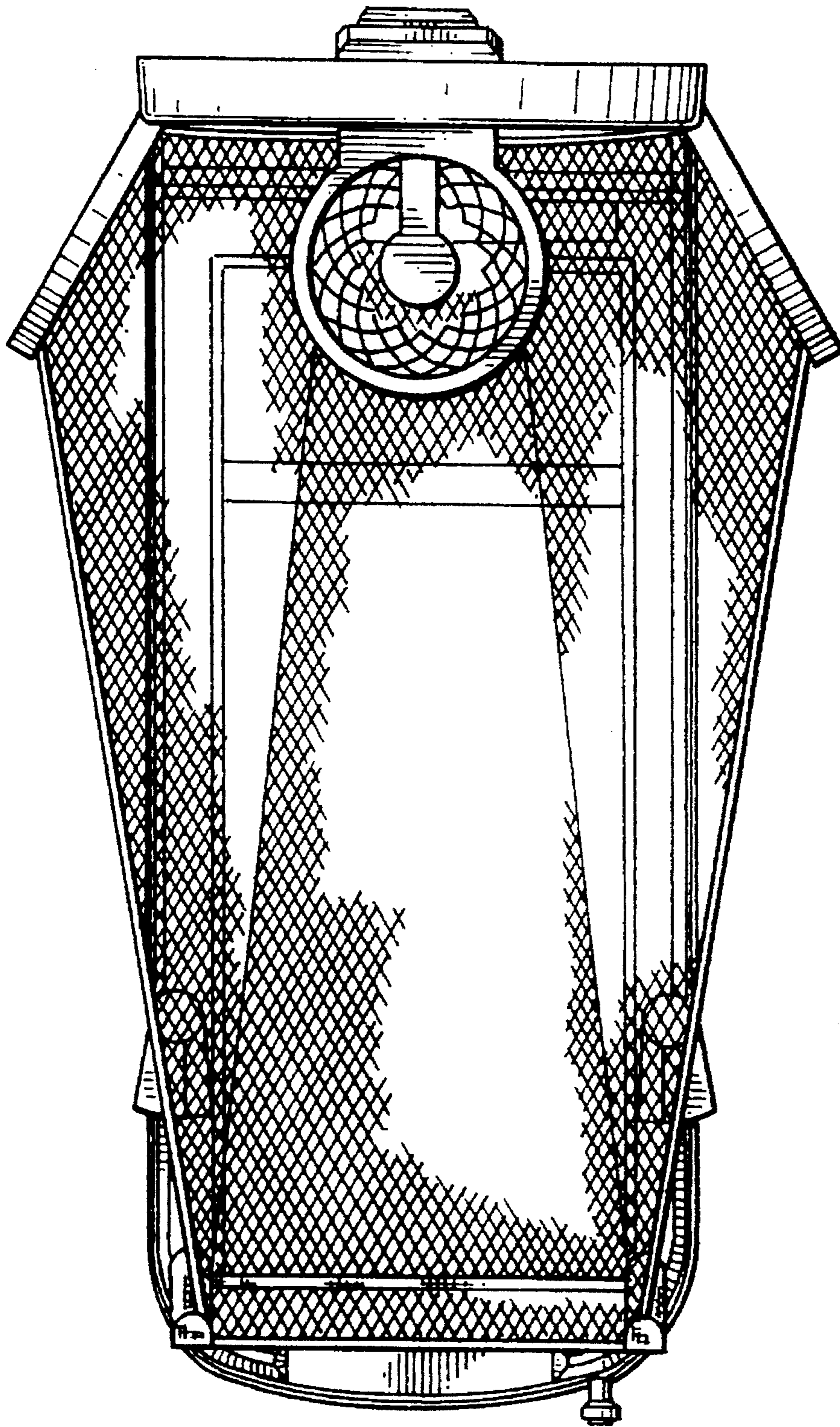

FIG. 5

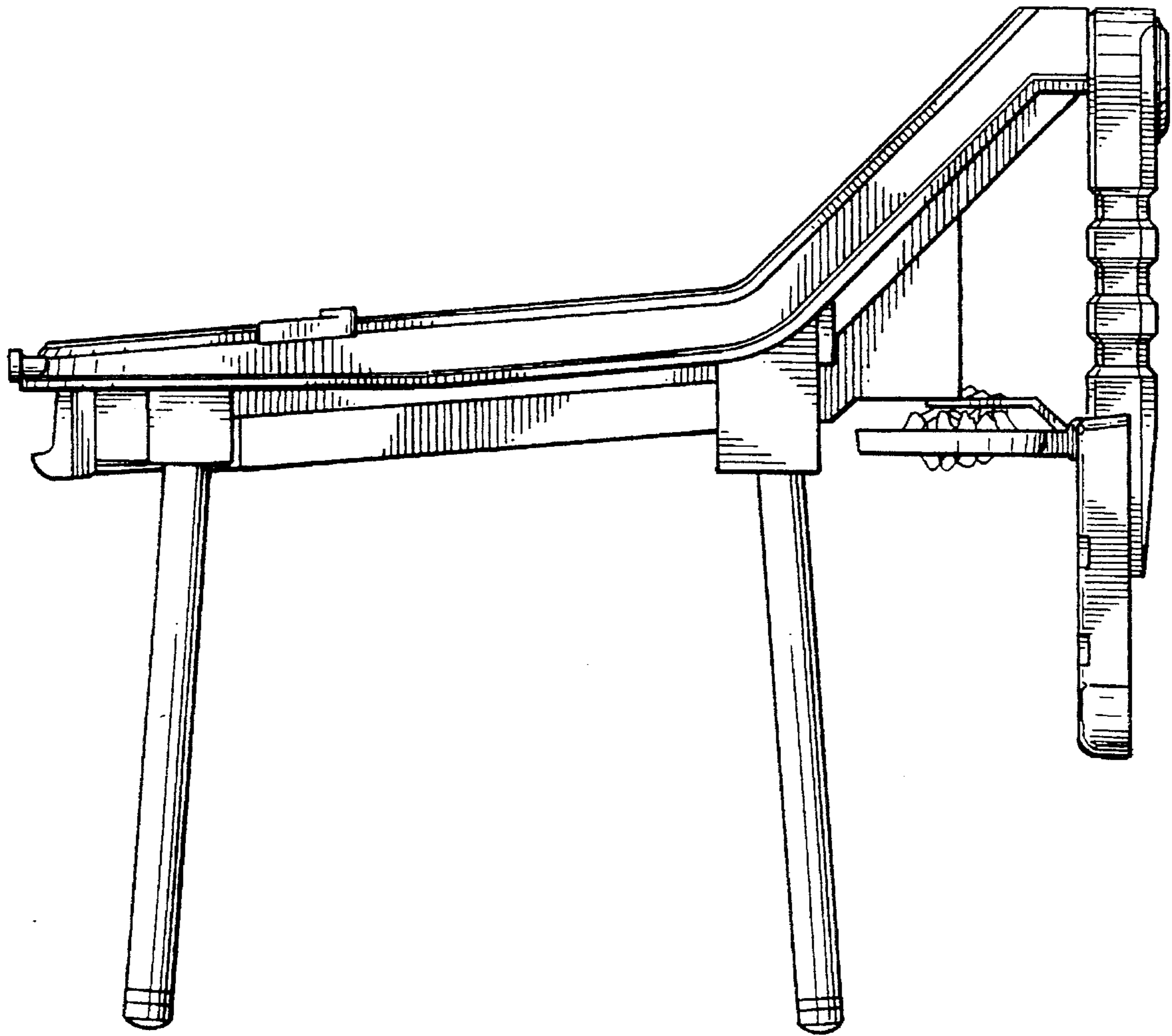

FIG. 6

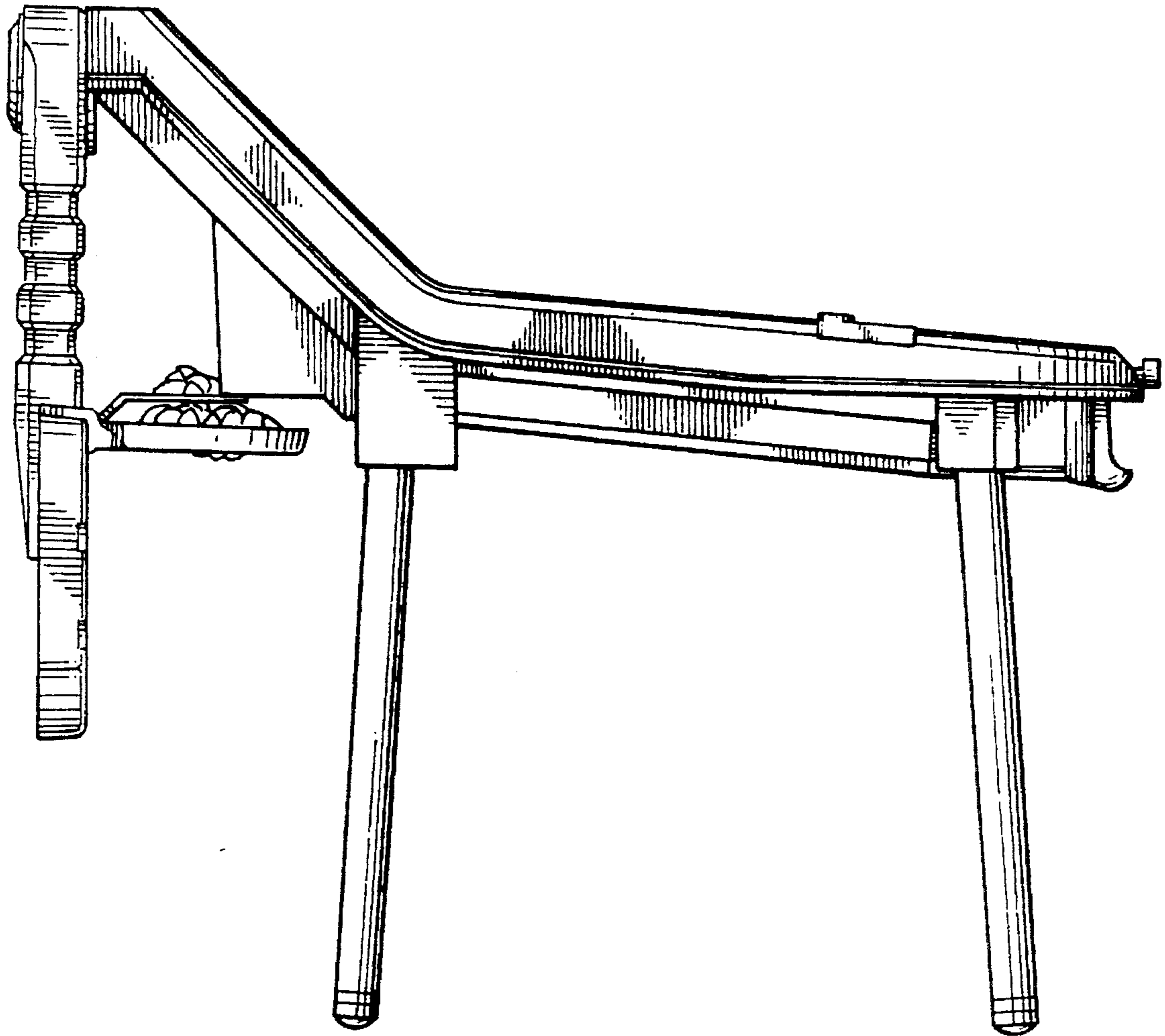

FIG. 7

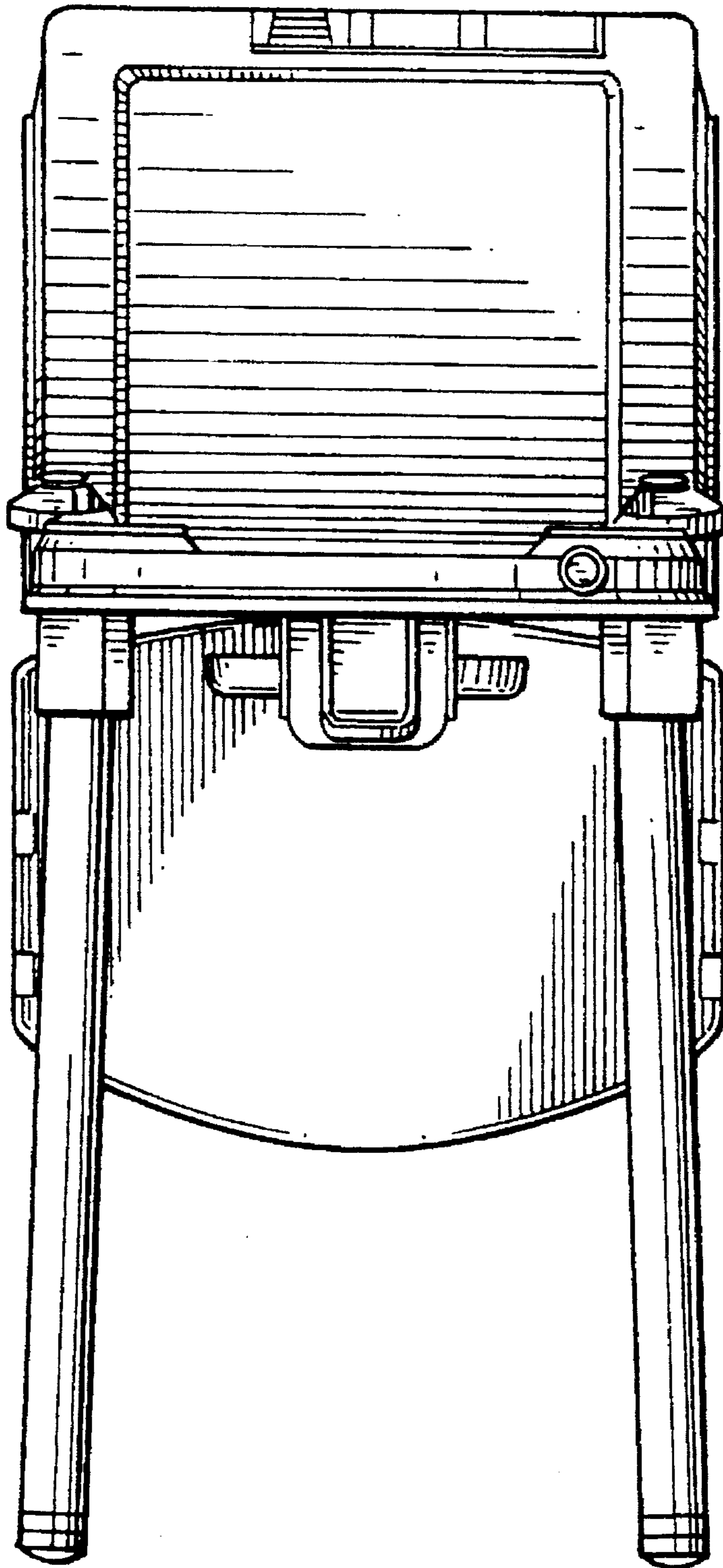

FIG. 8

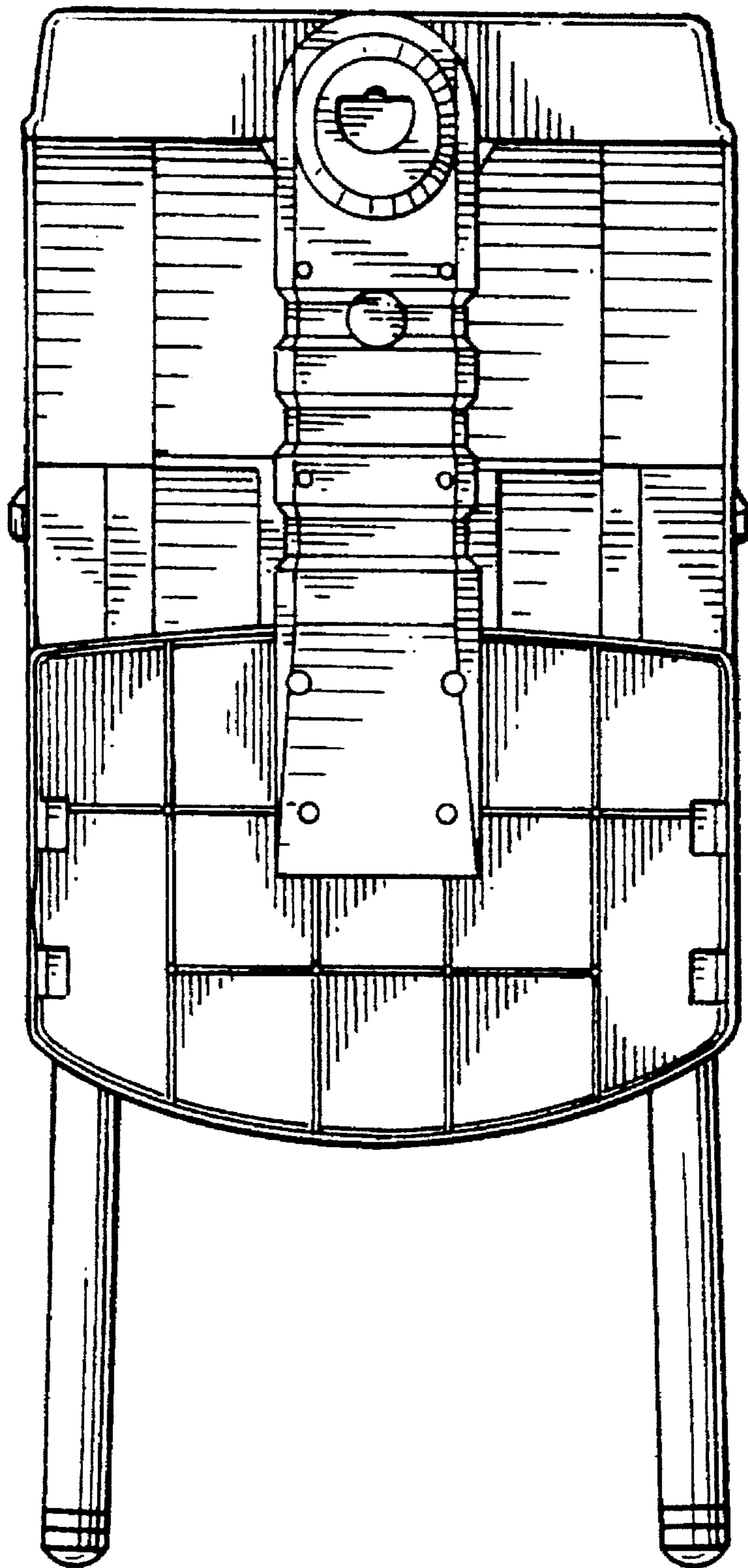

FIG. 9

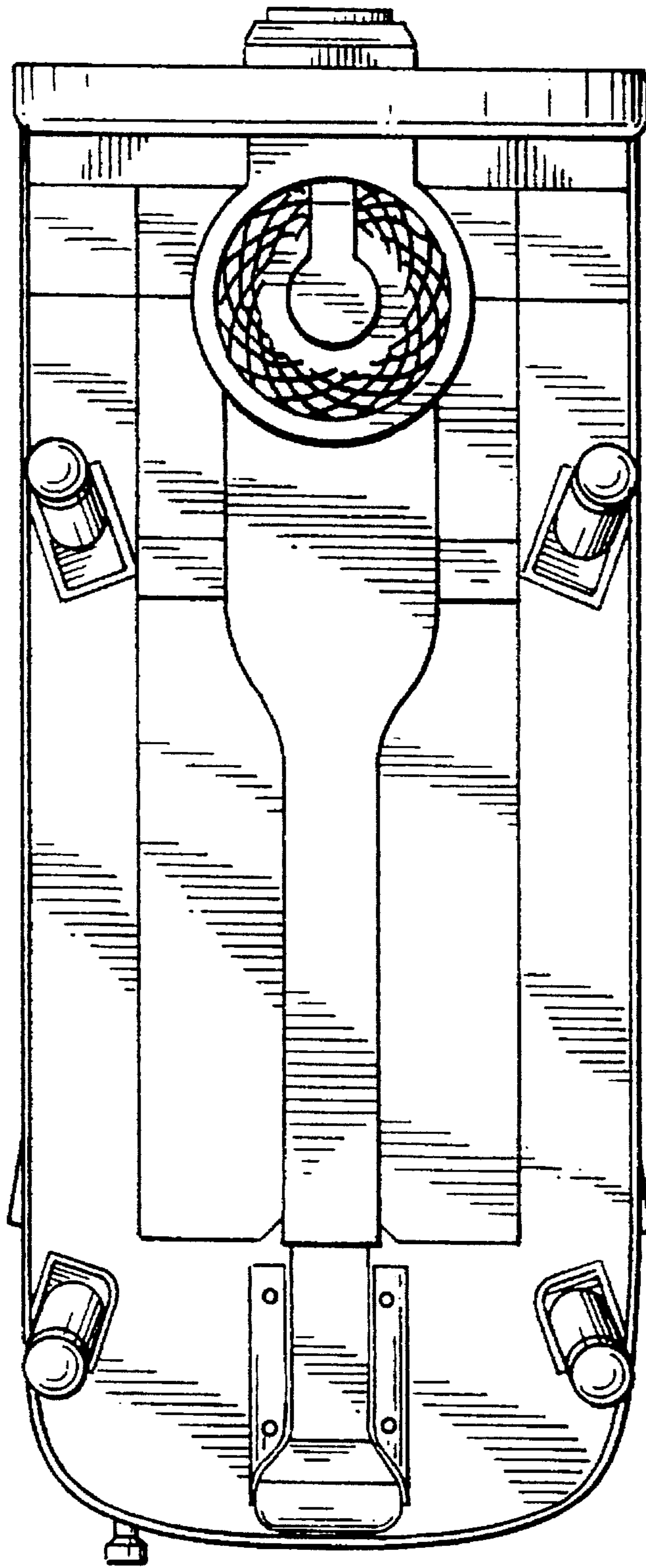

FIG. 10

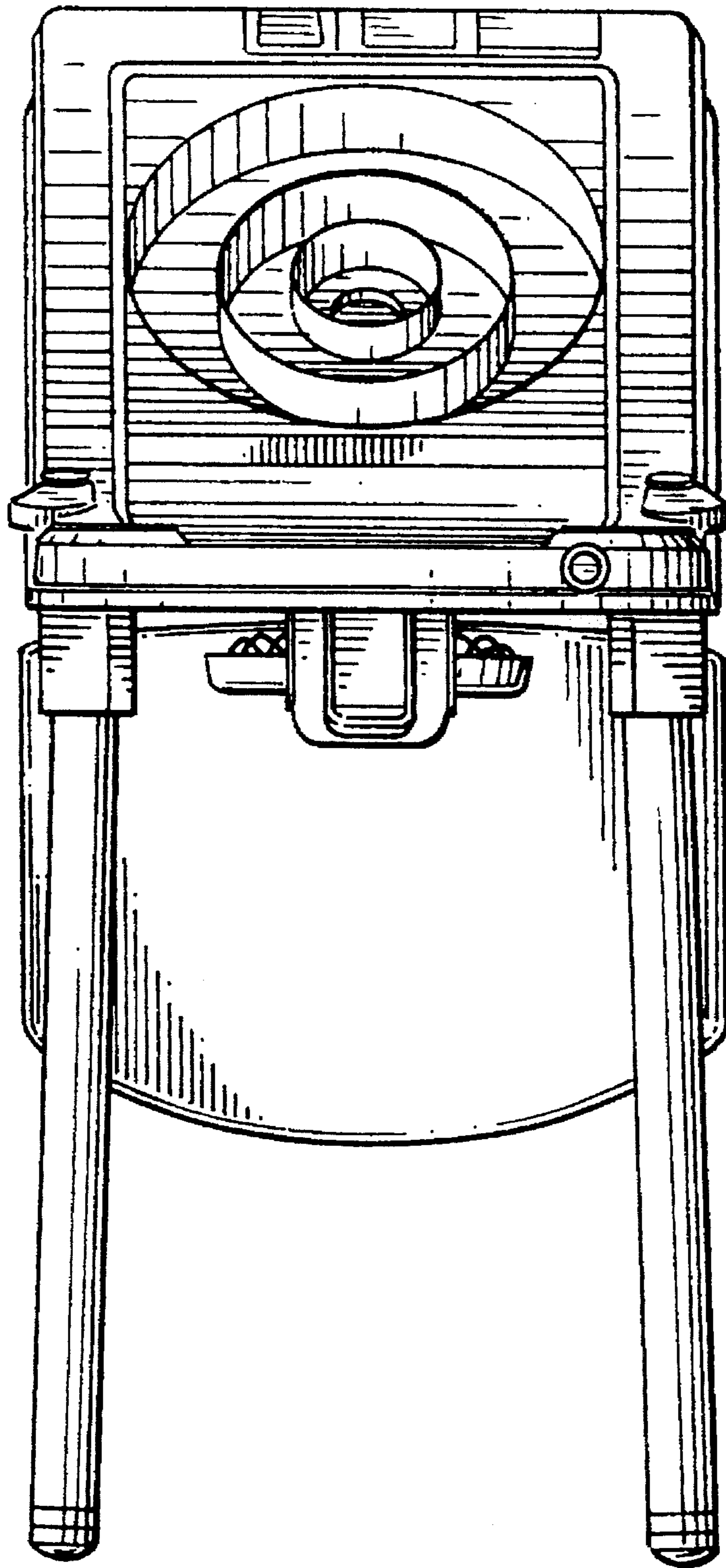

FIG. 11

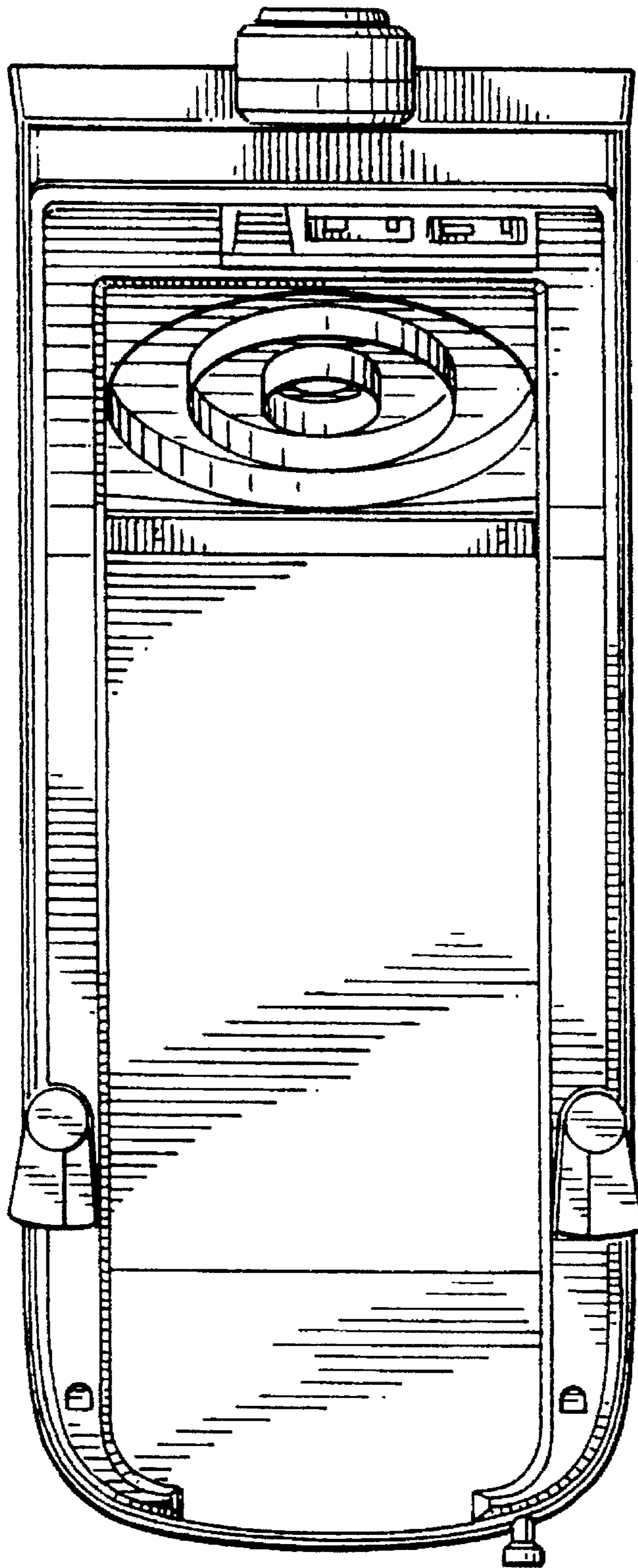

FIG. 12

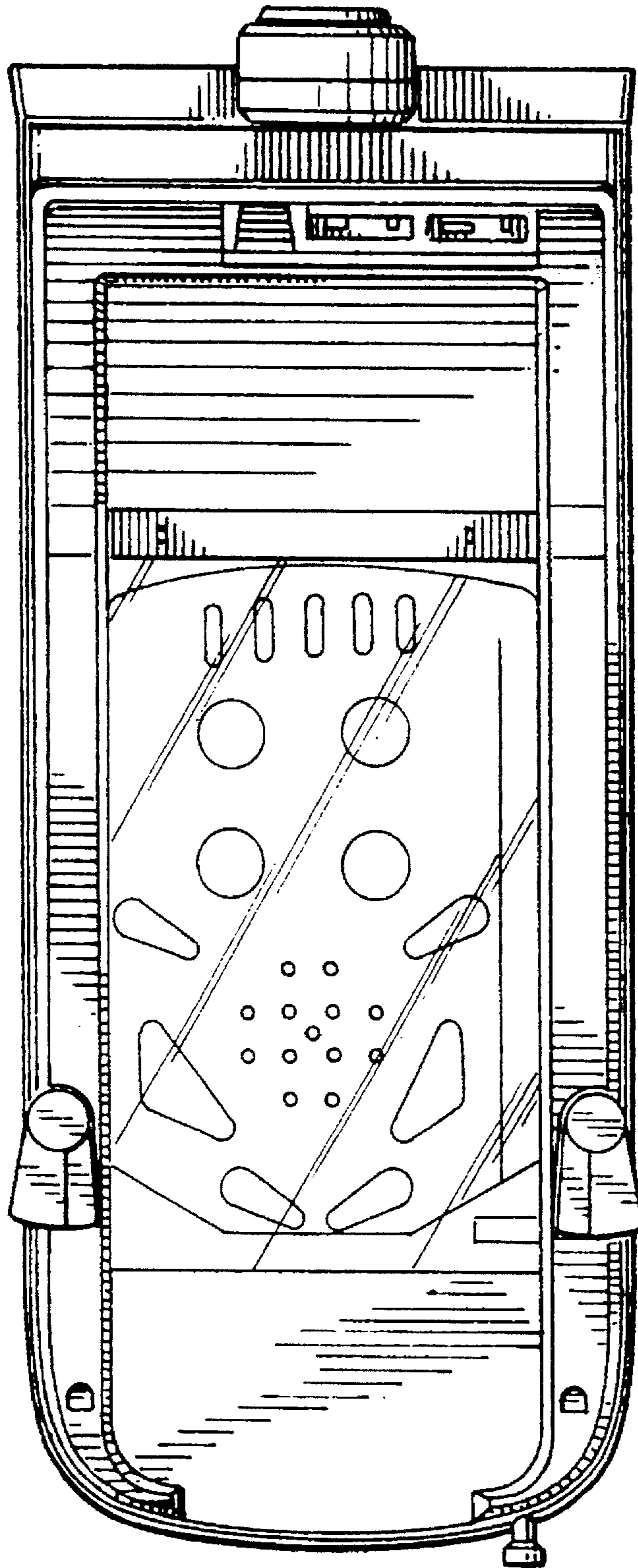

FIG. 13

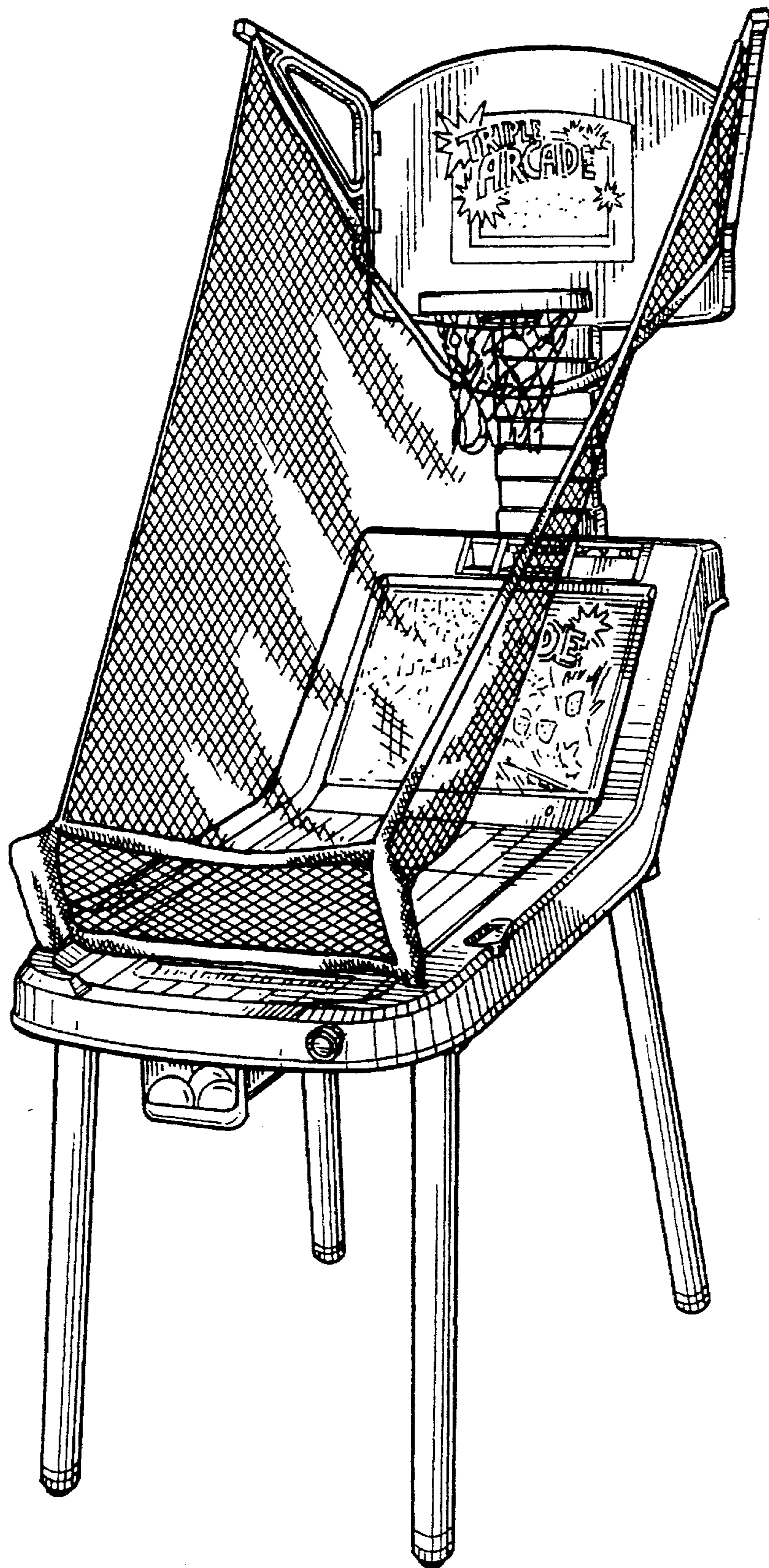

FIG. 14

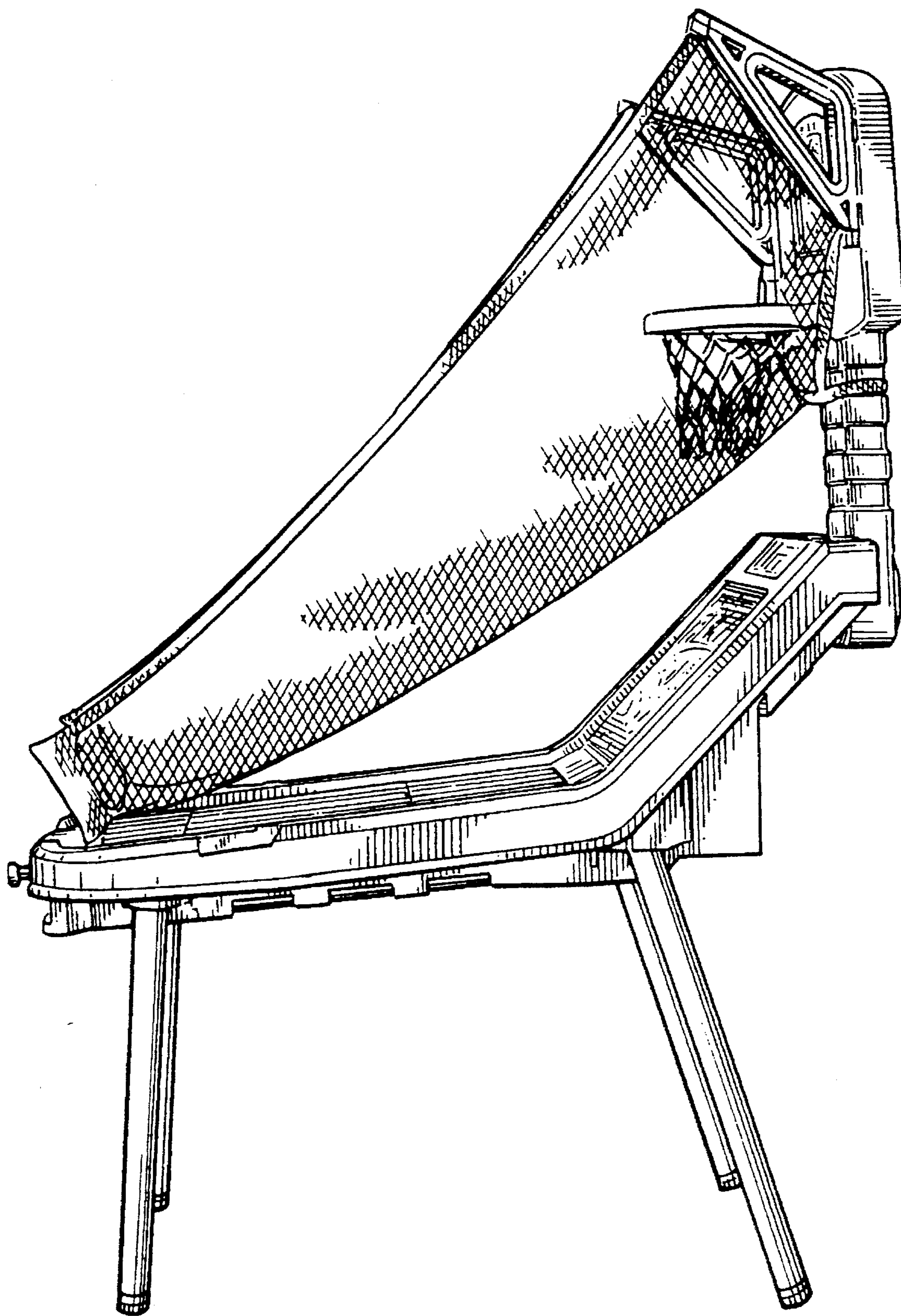

FIG. 15

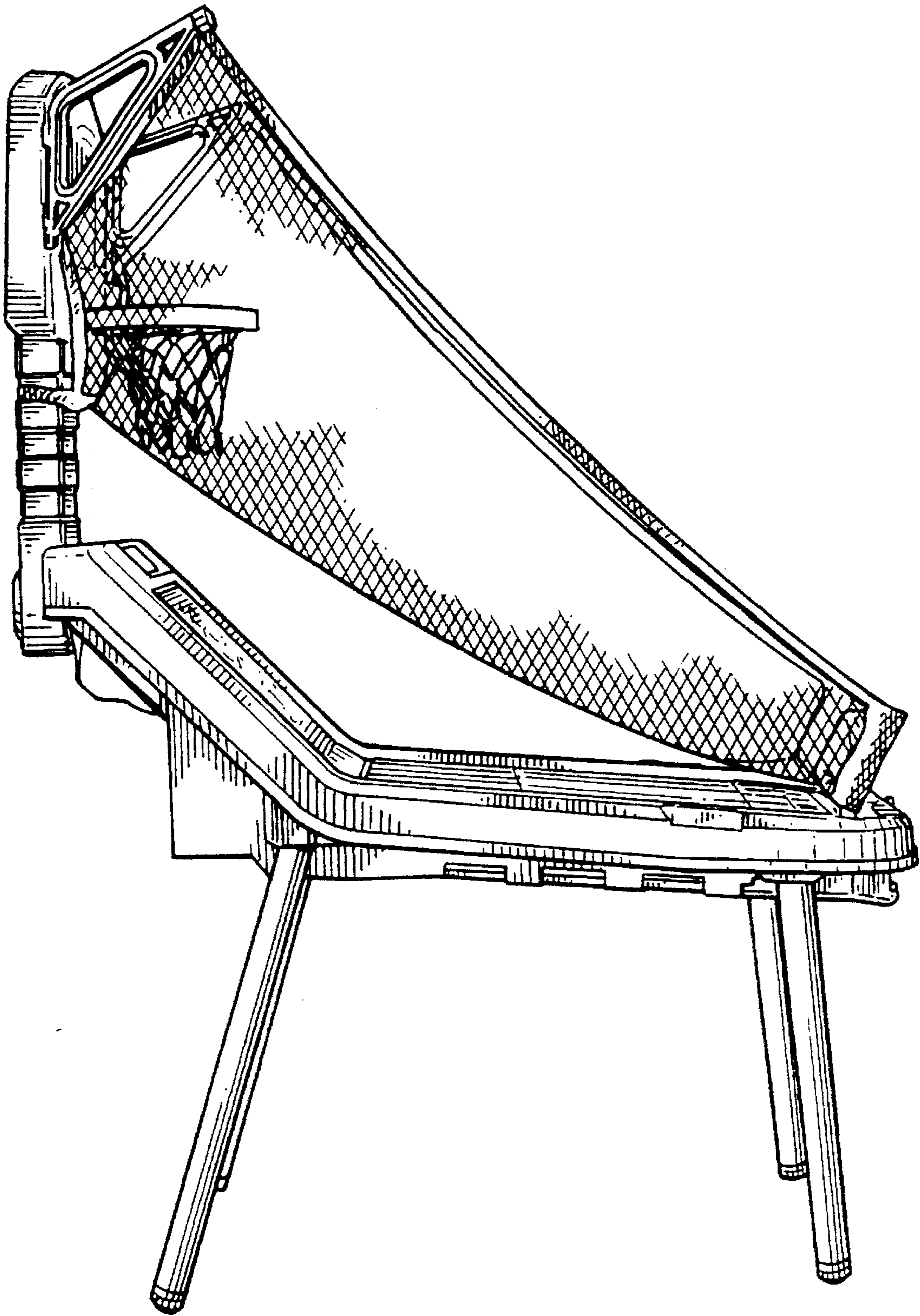

FIG. 16

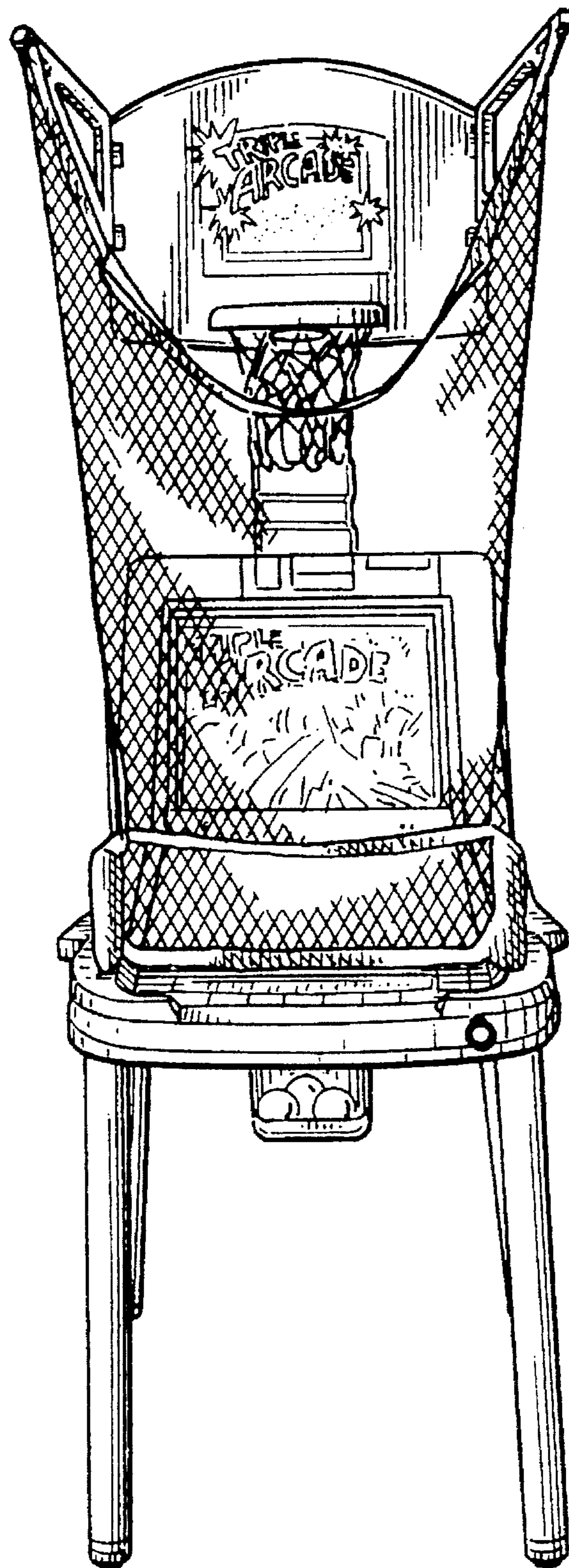

FIG. 17

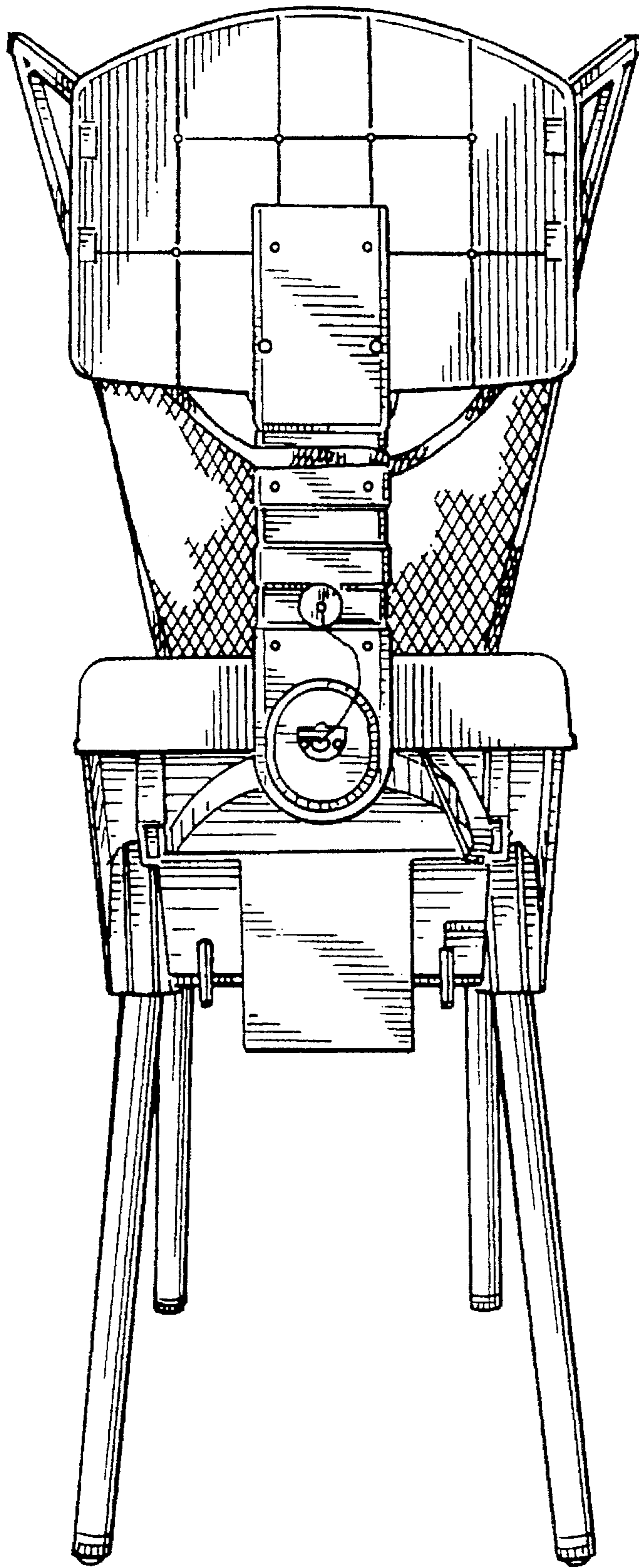

FIG. 18

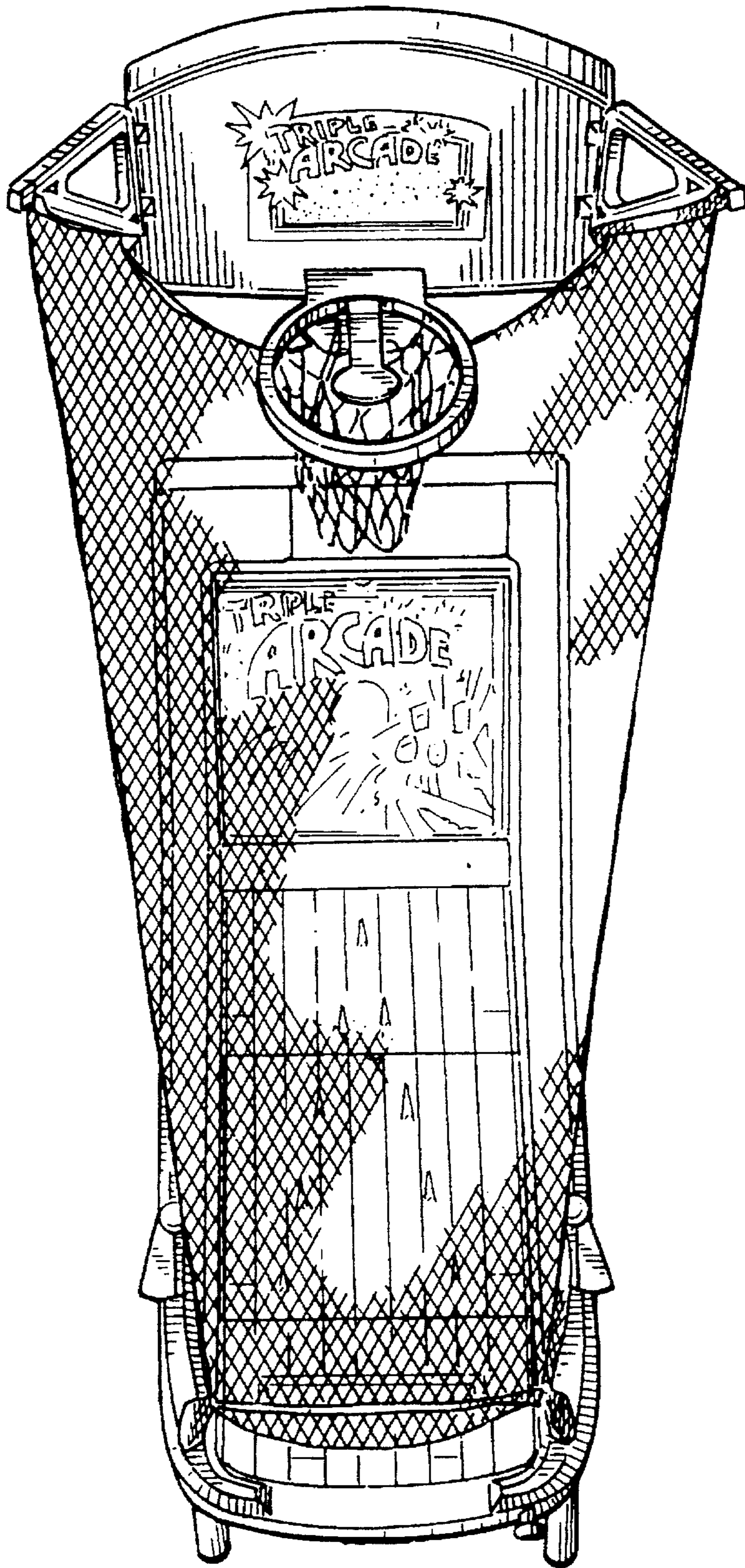

FIG. 19

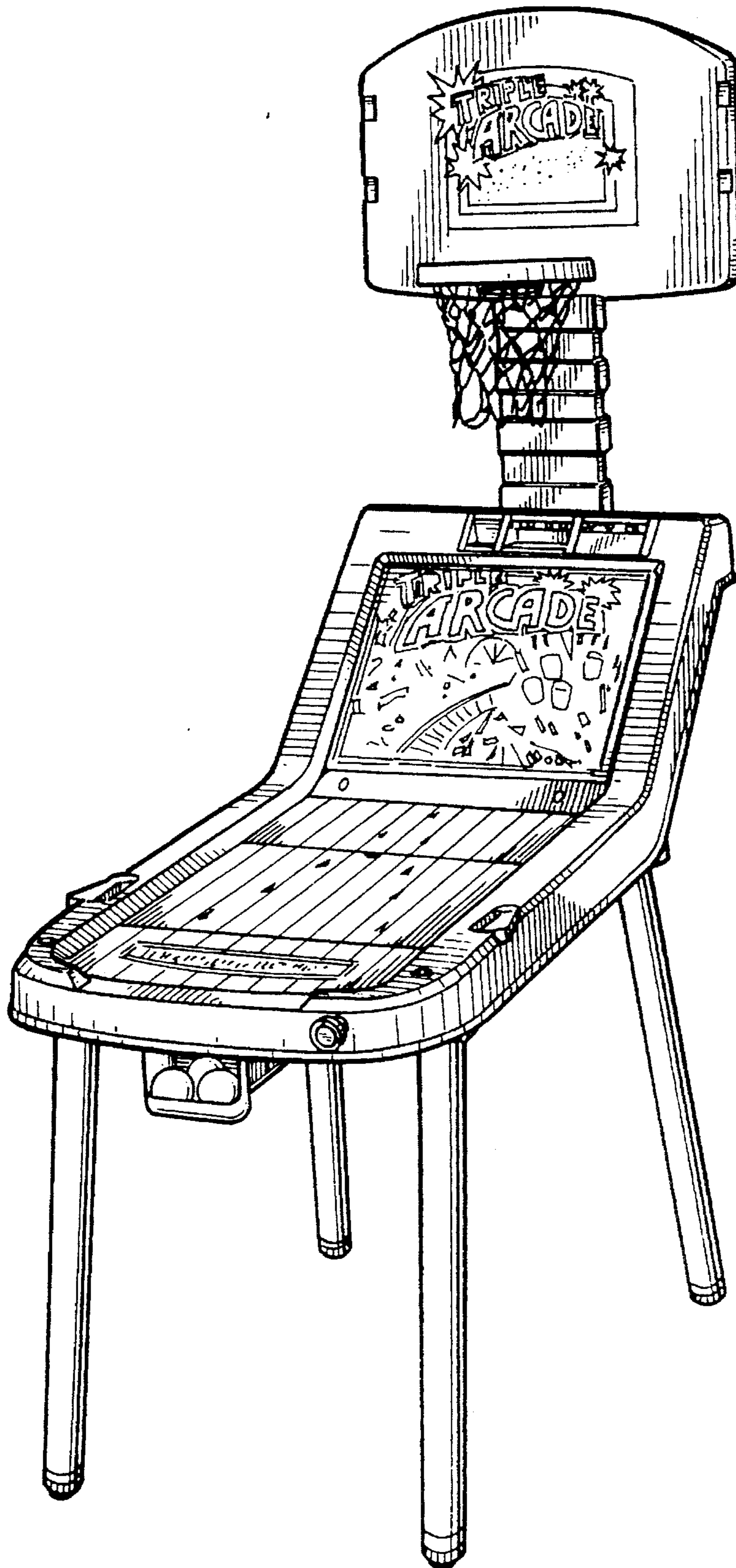

FIG. 20

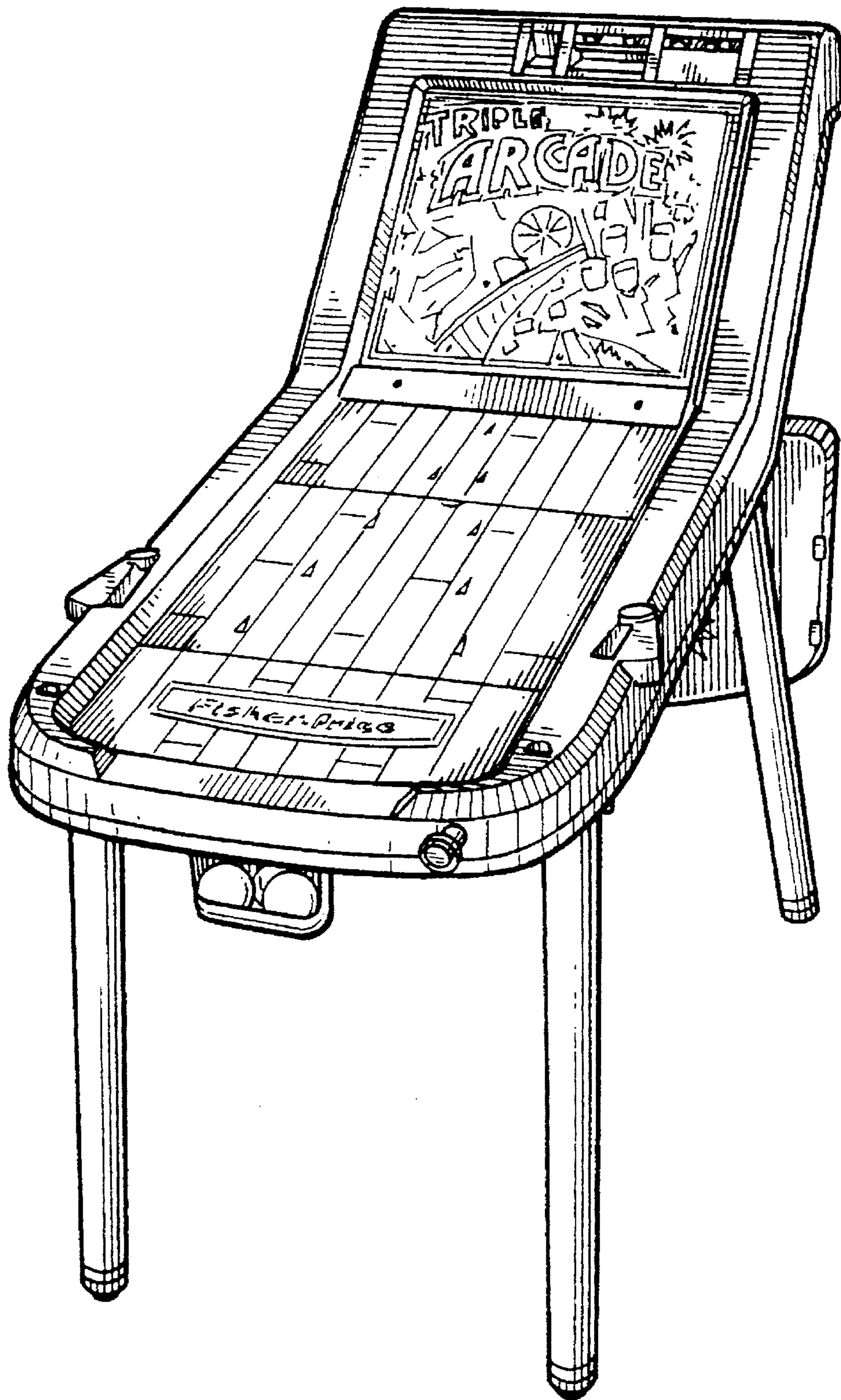

FIG. 21

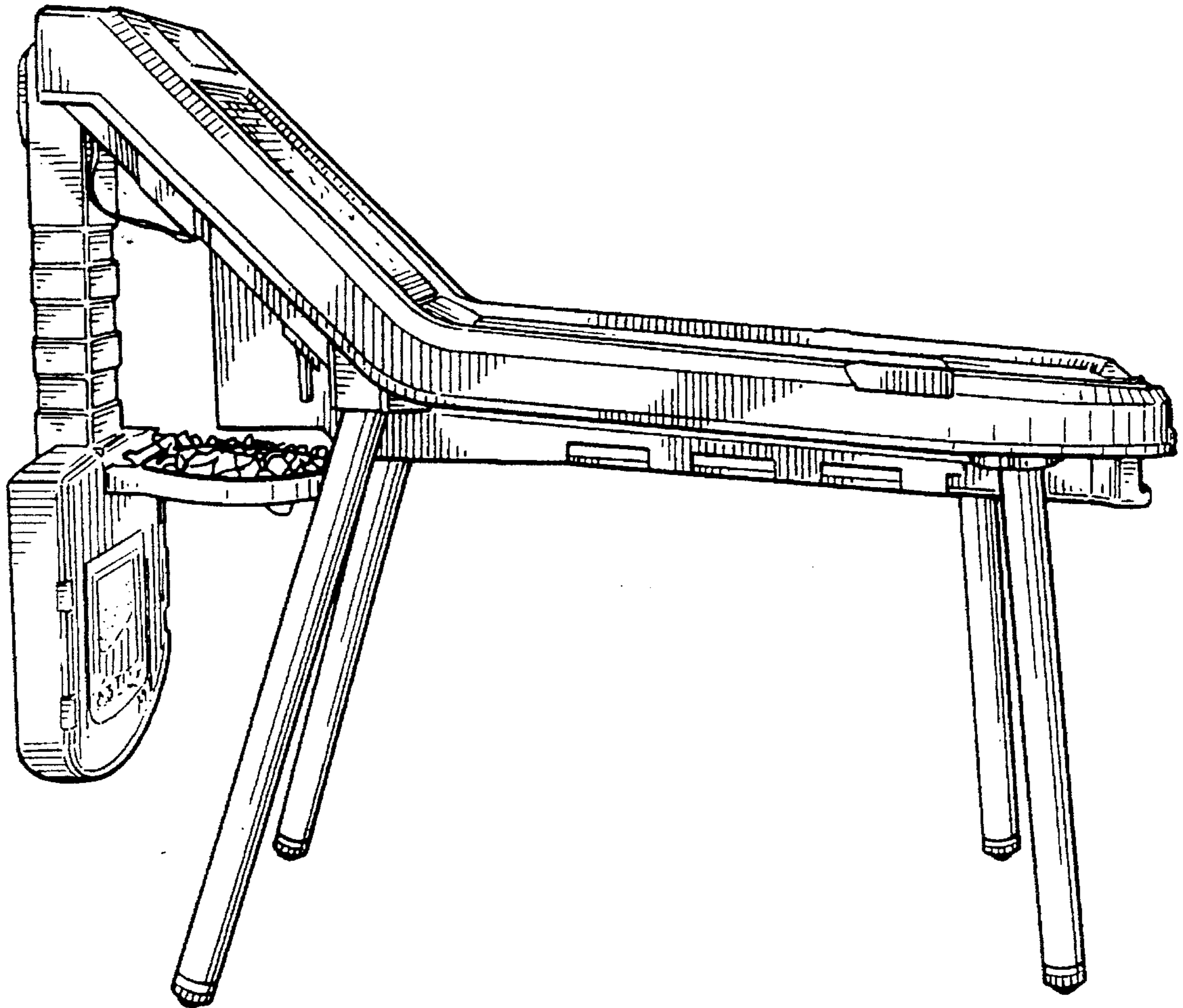

FIG. 22

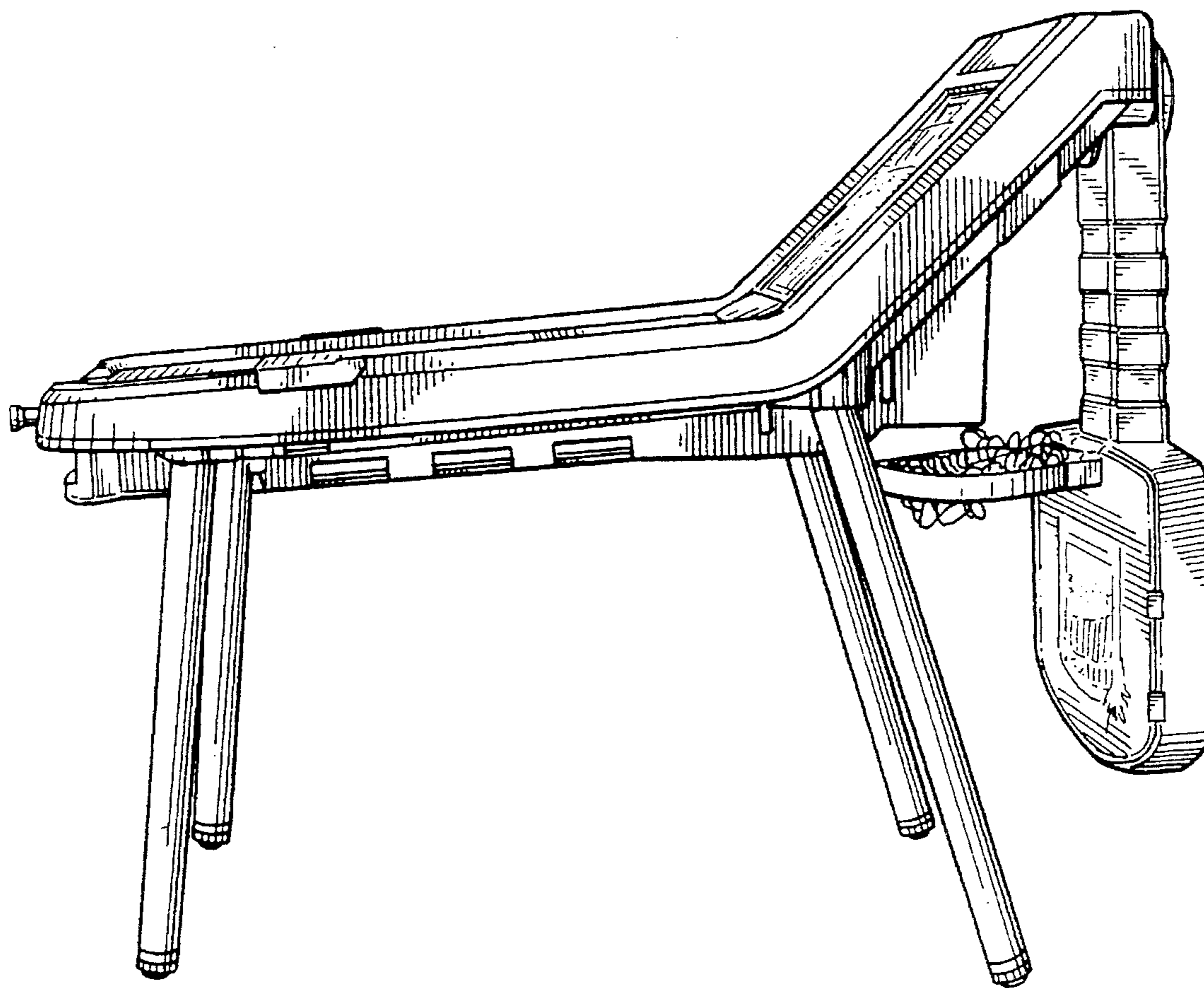

FIG. 23

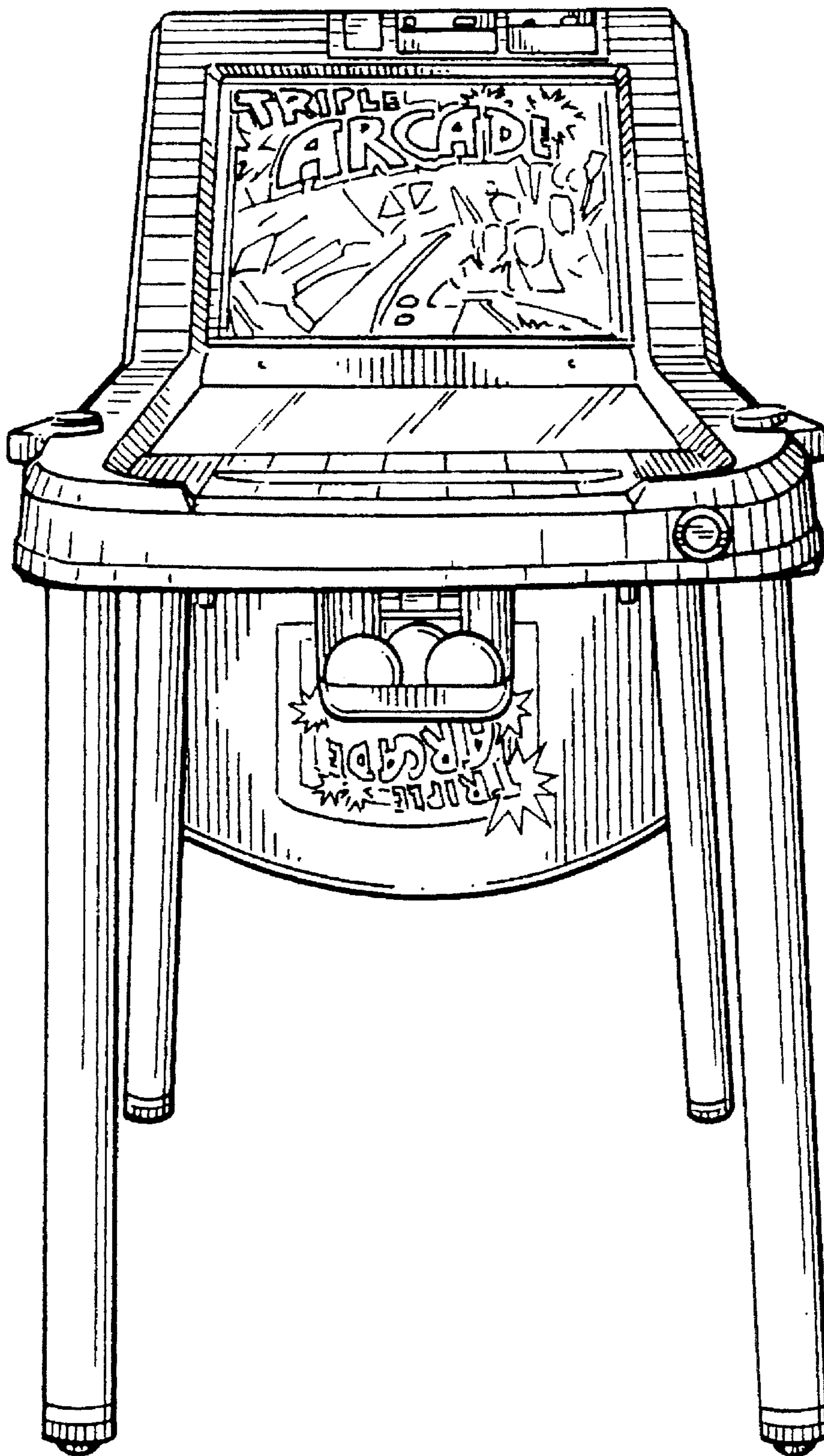

FIG. 24

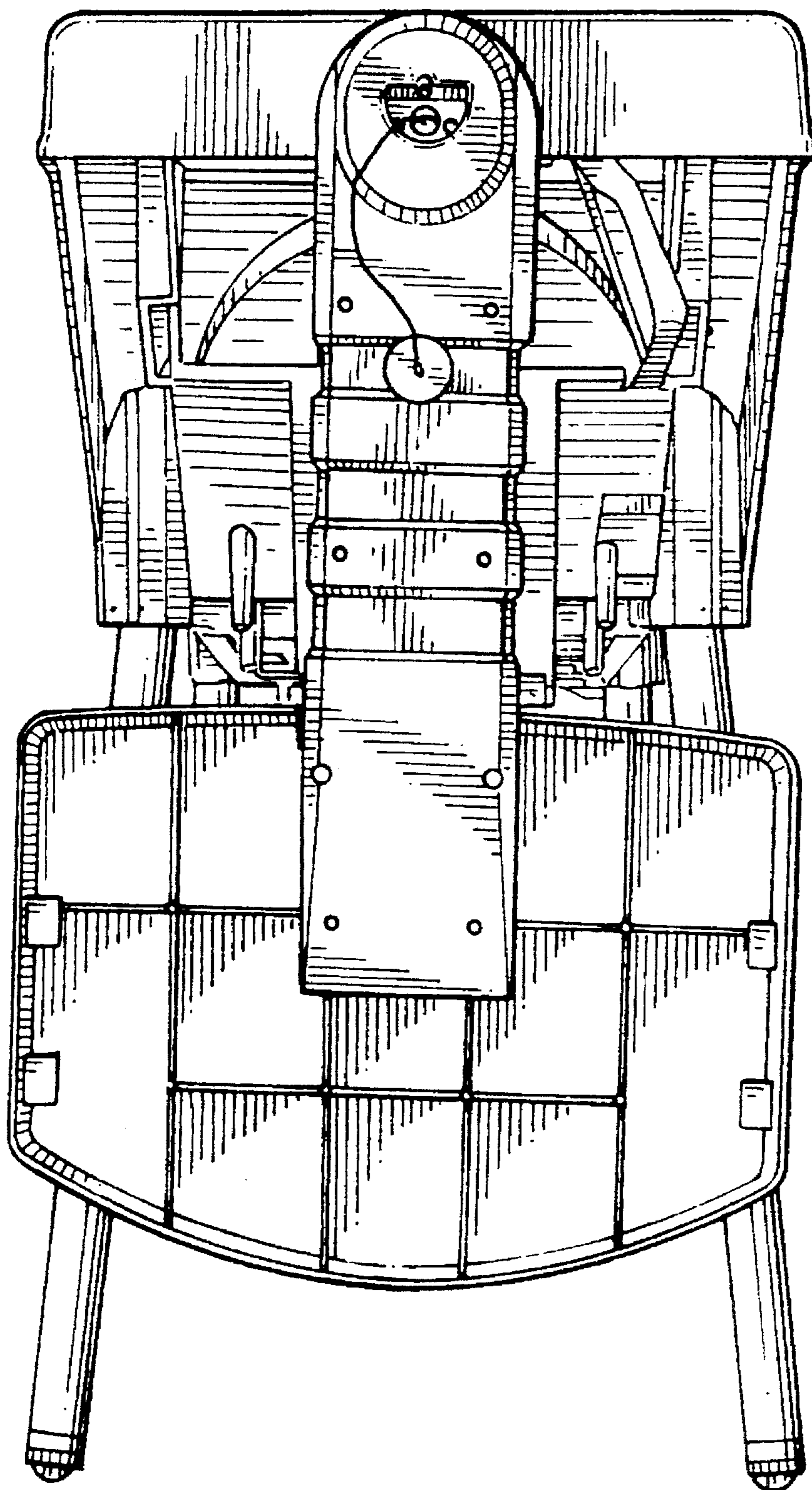

FIG. 25

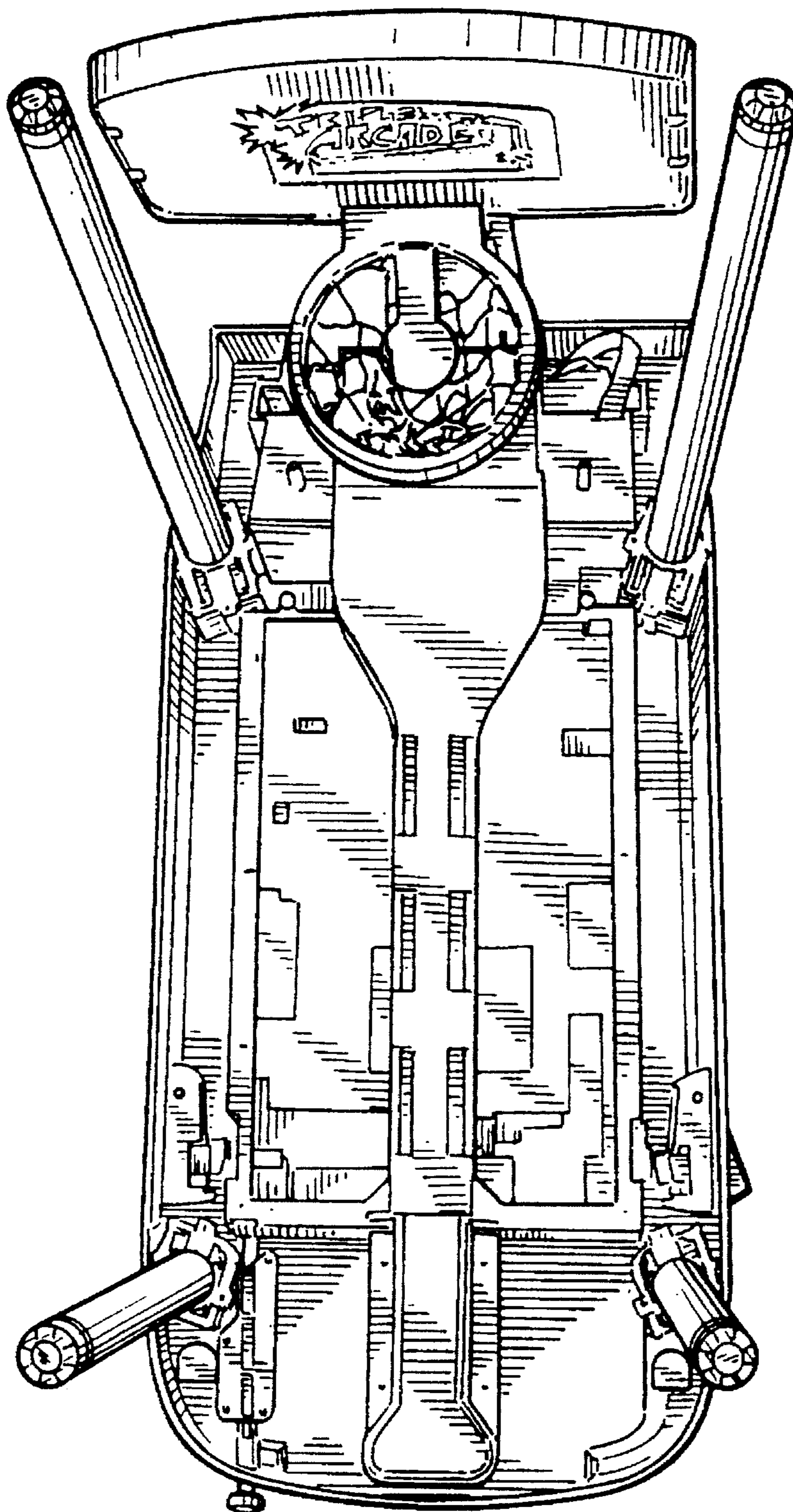

FIG. 26

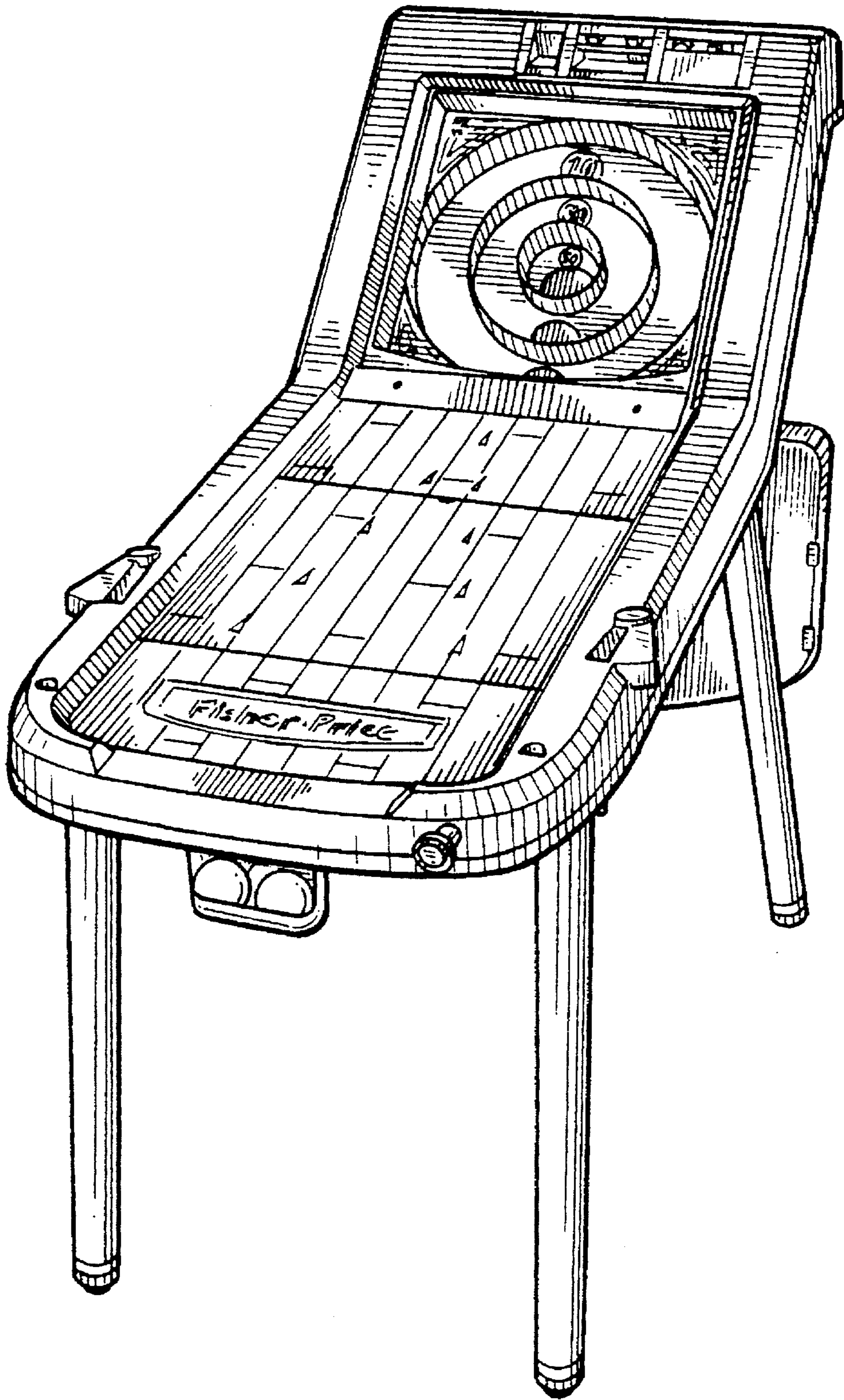

FIG. 27

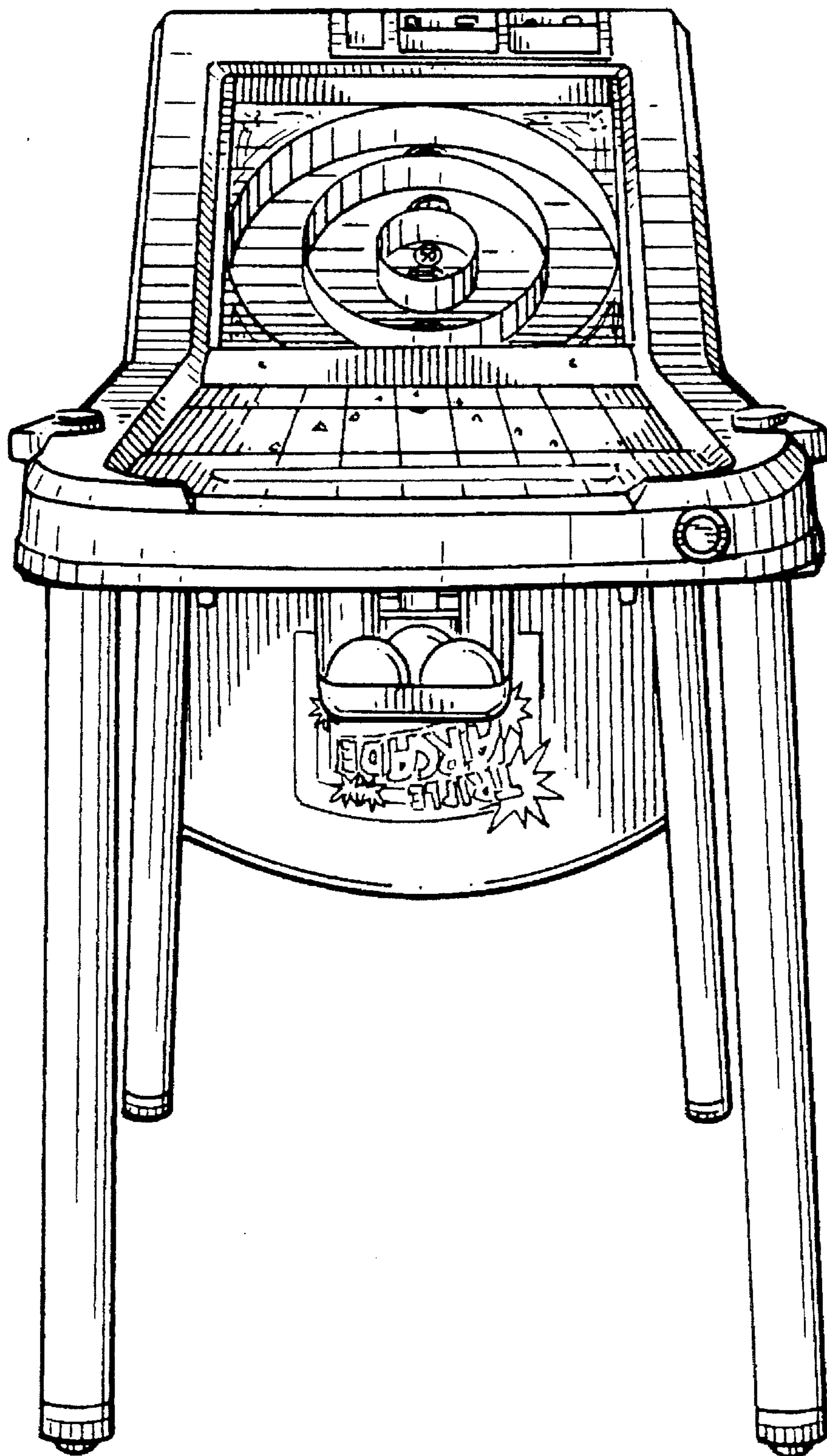

FIG. 28

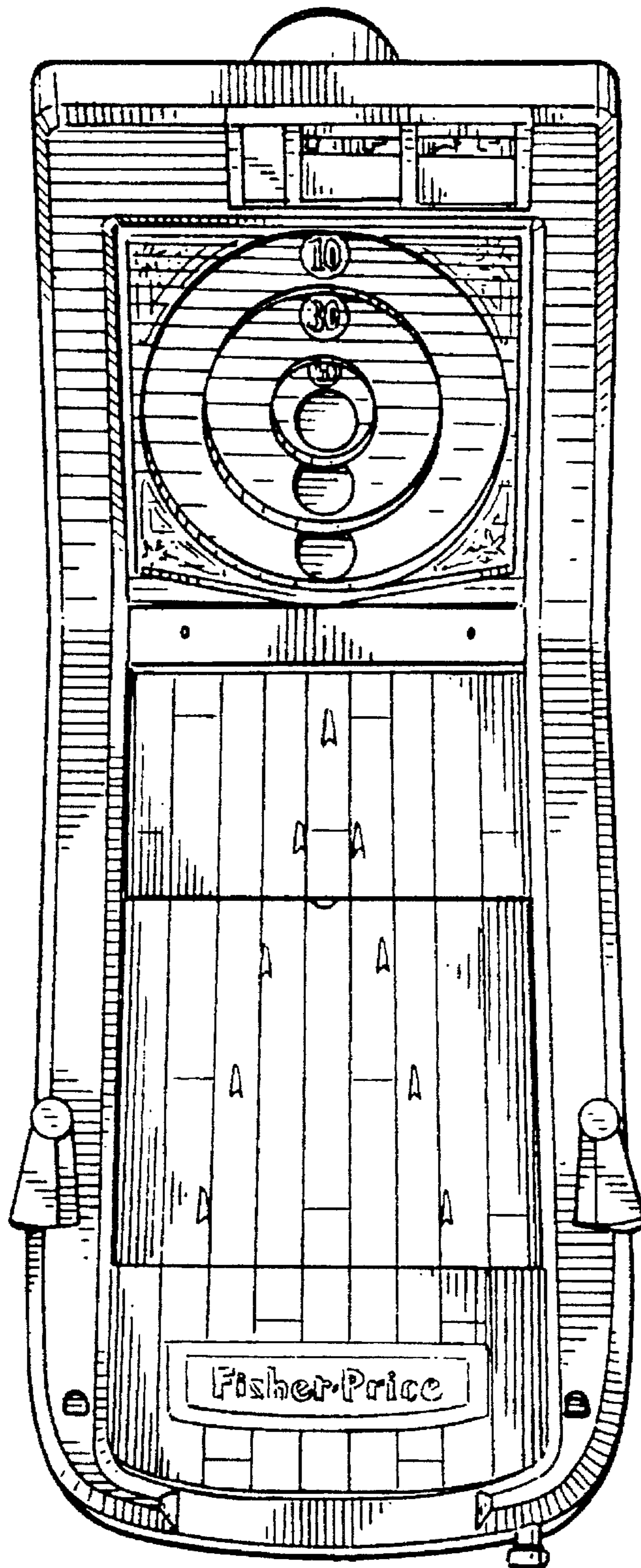

FIG. 29

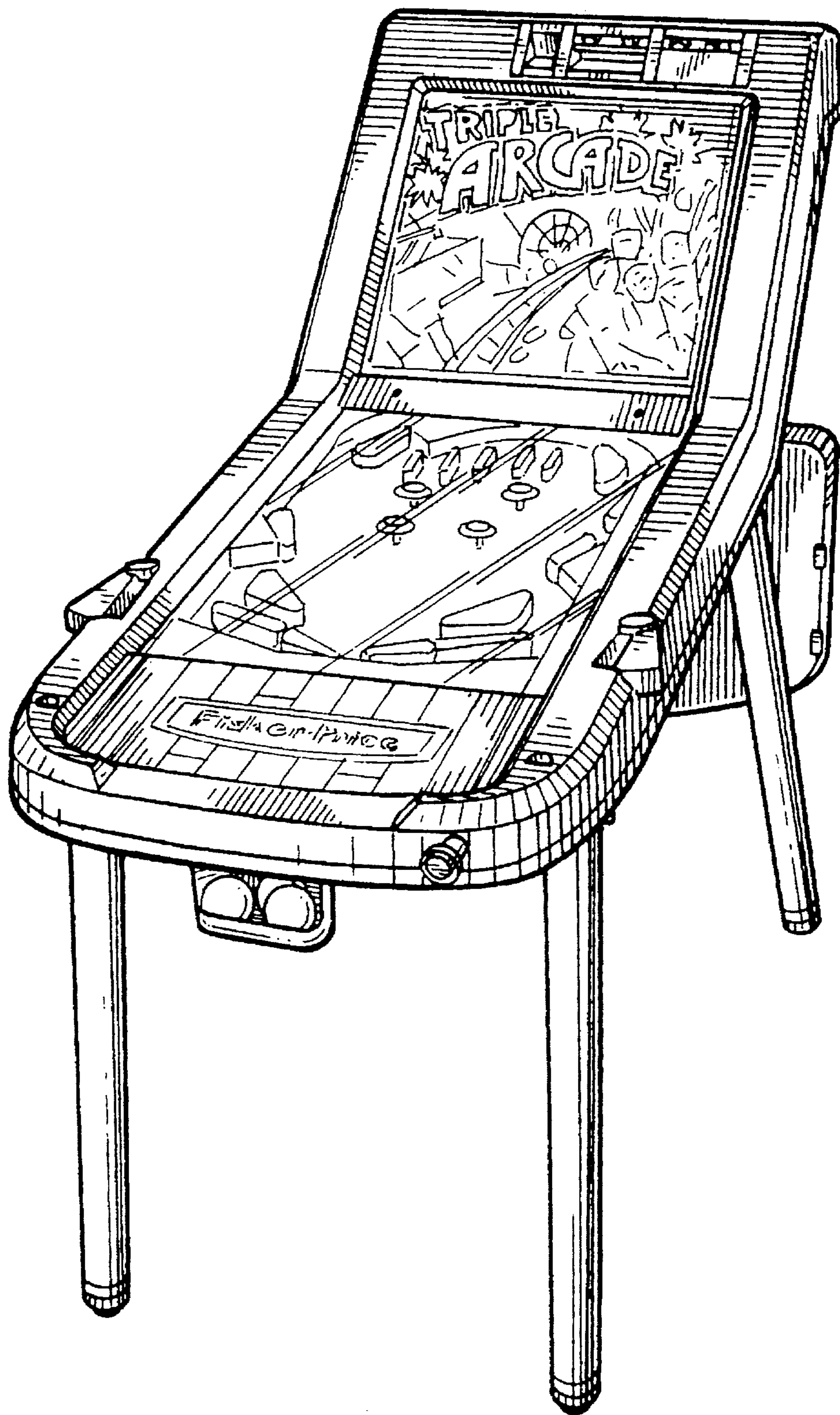

FIG. 30

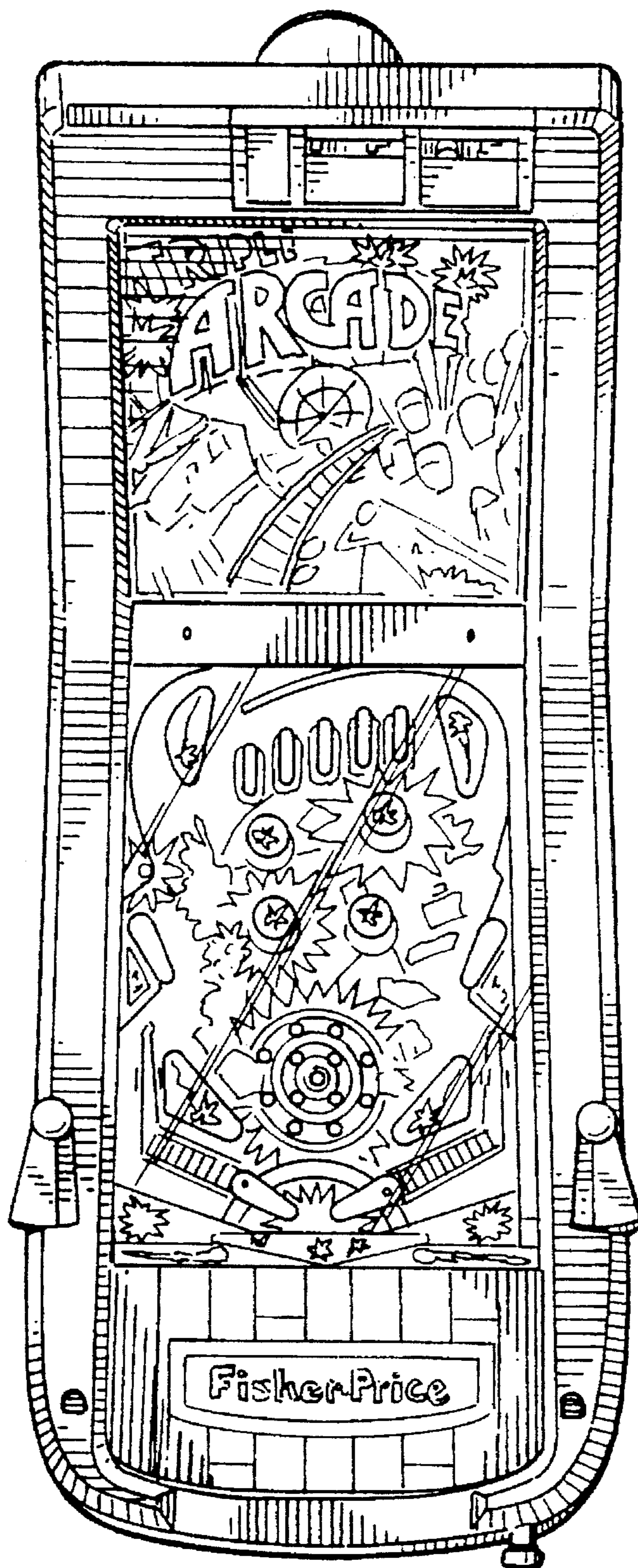

FIG. 31

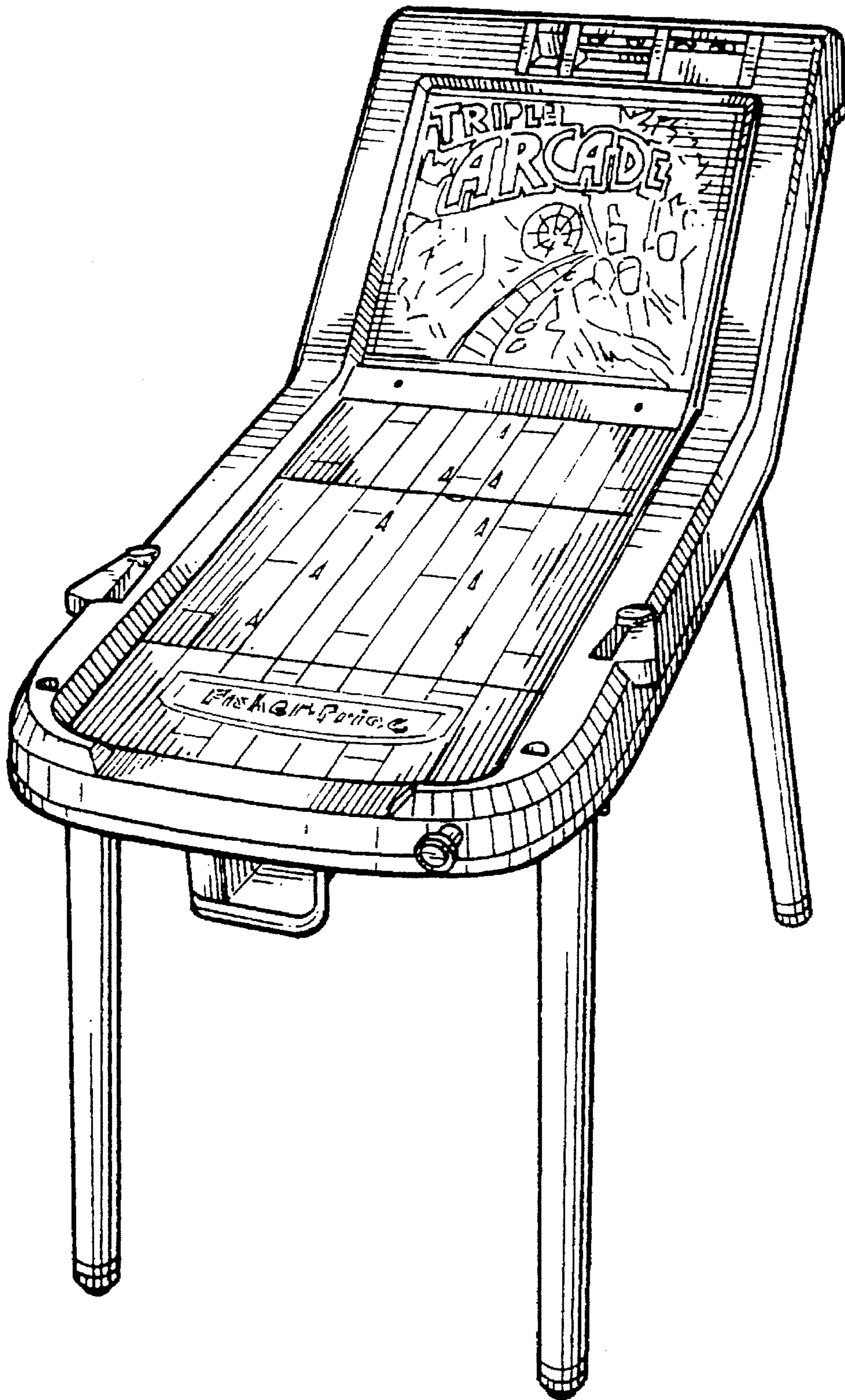

FIG. 32

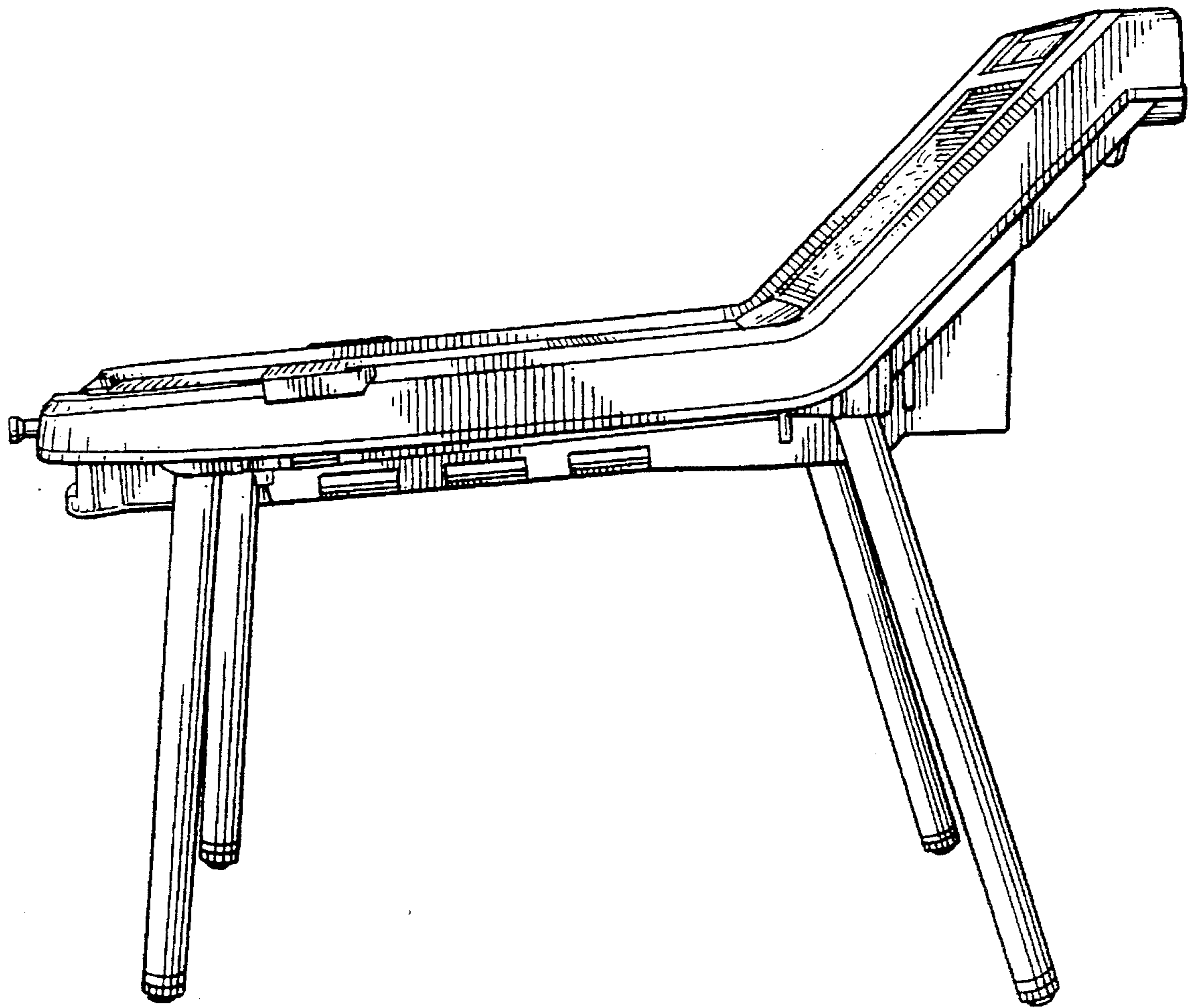

FIG. 33

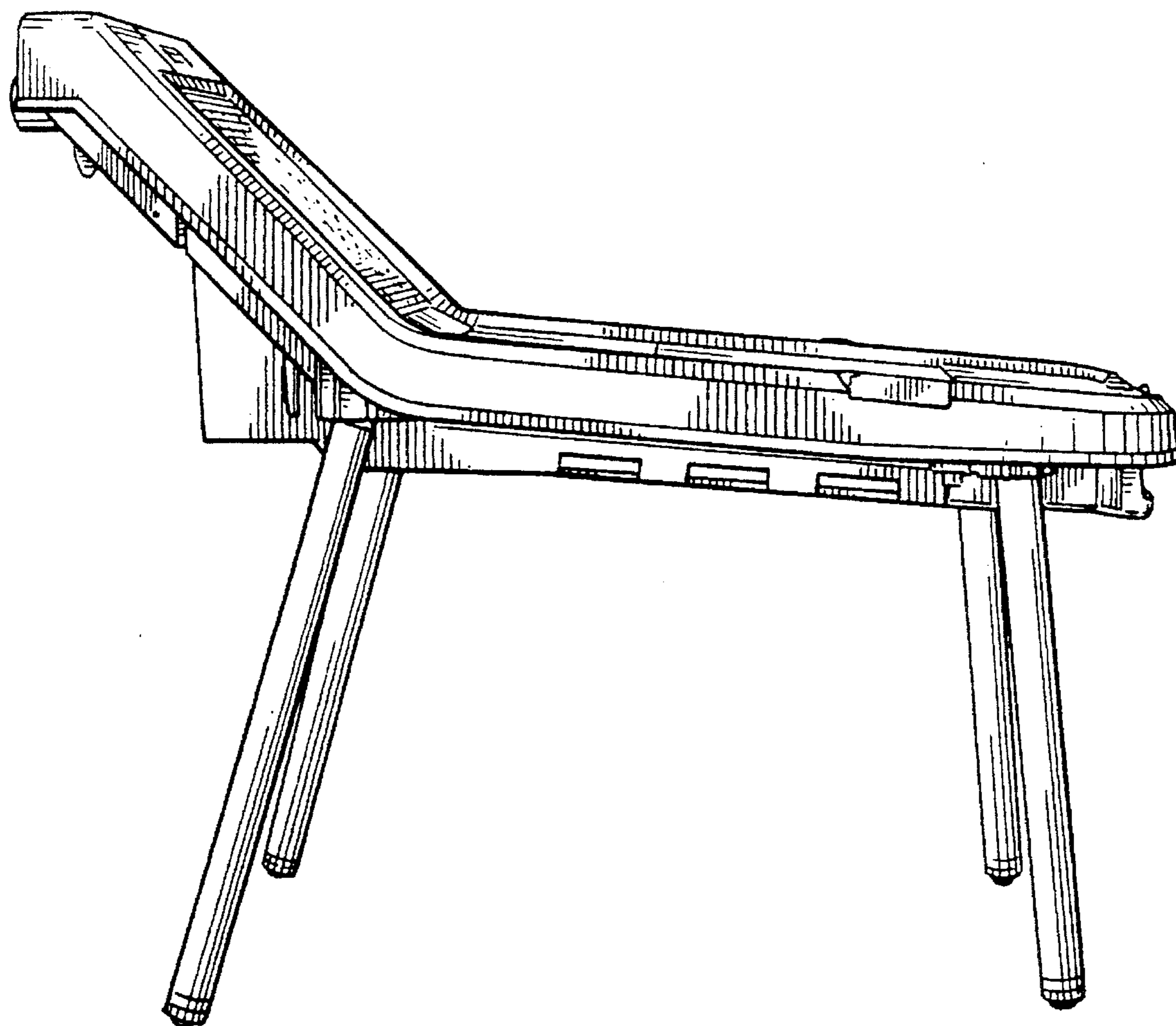

FIG. 34

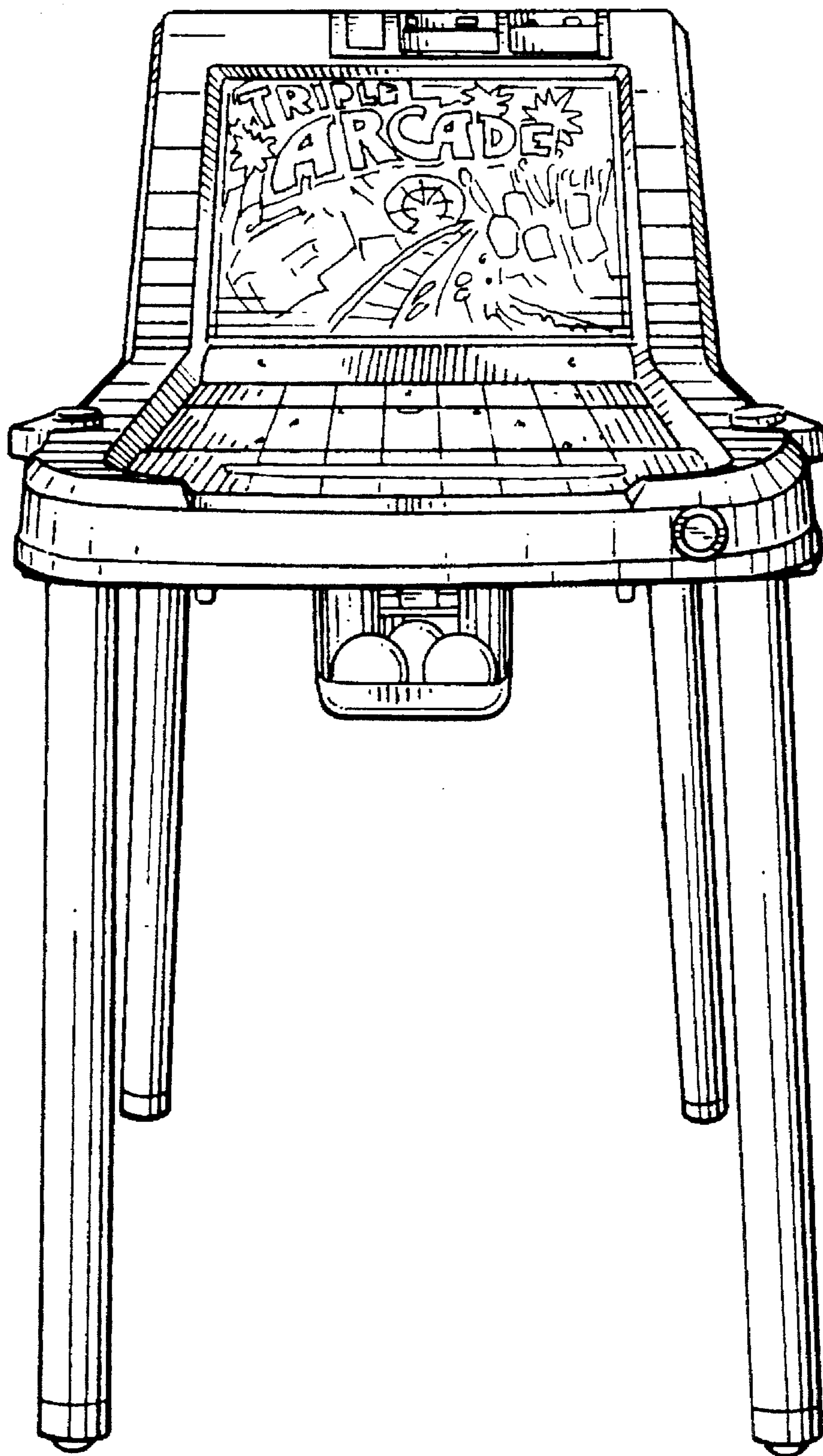

FIG. 35

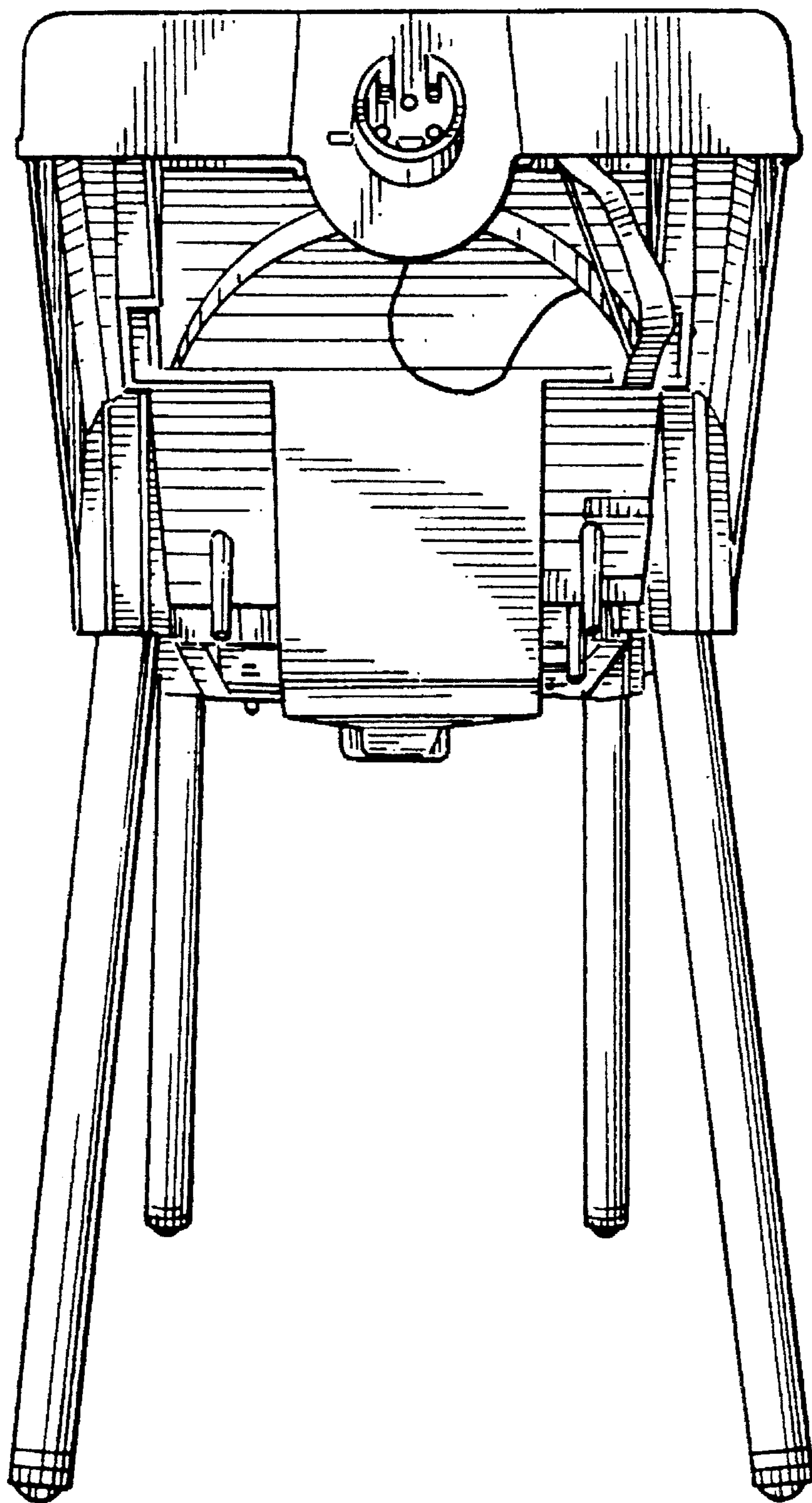

FIG. 36

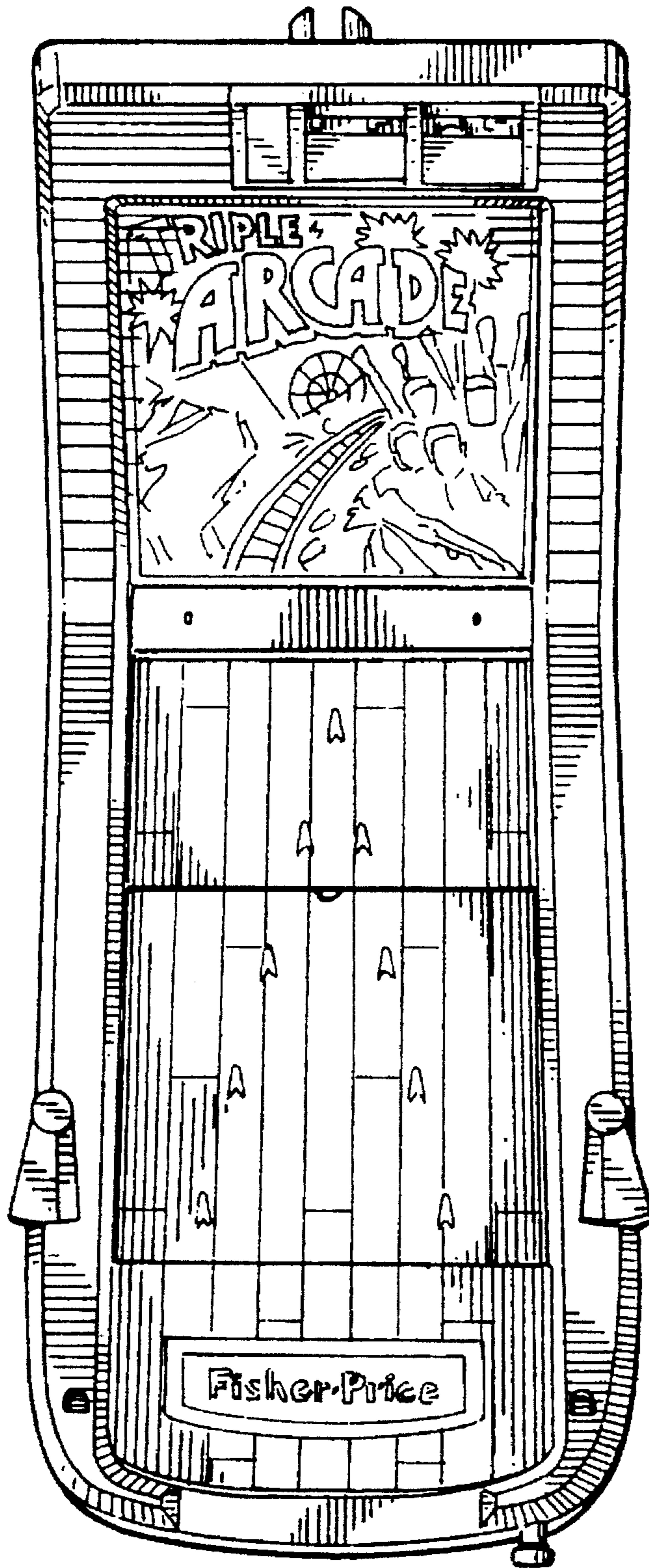

FIG. 37

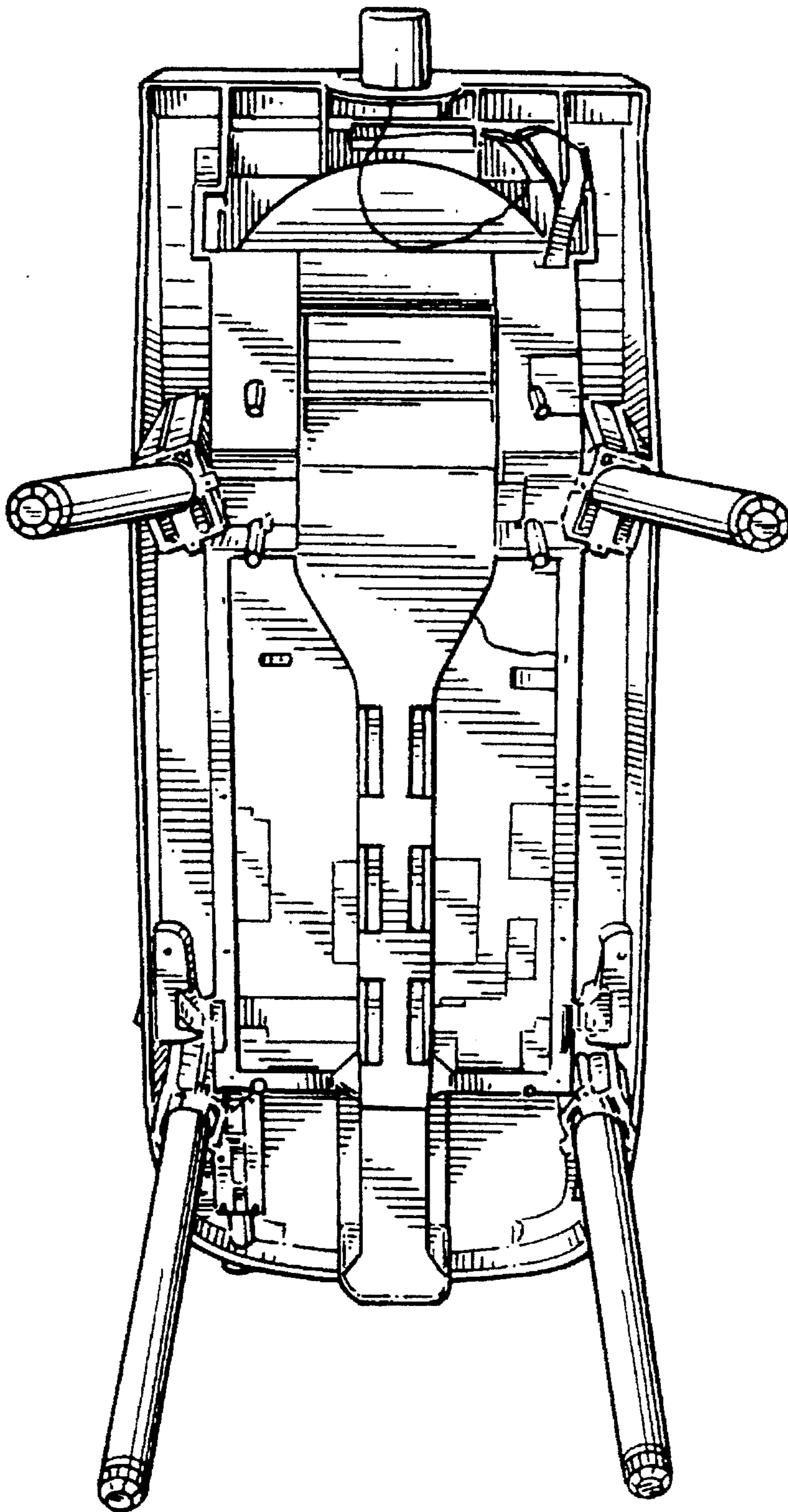

FIG. 38