



US00D372714S

United States Patent [19] Pinchuk

[11] Patent Number: **Des. 372,714**

[45] Date of Patent: ****Aug. 13, 1996**

[54] **HAND HELD RECORDER WITH GRAPHICAL DISPLAY REPRESENTATION**

[75] Inventor: **Rene C. Pinchuk**, Kennington, Calif.

[73] Assignee: **Sharper Image Corporation**, San Francisco, Calif.

[**] Term: **14 Years**

[21] Appl. No.: **43,779**

[22] Filed: **Sep. 12, 1995**

[52] U.S. Cl. **D14/168**; D14/165

[58] Field of Search D6/300, 308, 314;
D14/124, 160-168, 188, 192; 40/152, 152.2,
455, 906; 455/344, 347, 350, 351

[56] **References Cited**

U.S. PATENT DOCUMENTS

D. 277,098	1/1985	Mark	D14/194
D. 290,119	6/1987	Trezise et al.	D14/189
D. 310,078	8/1990	Naito	D14/164
D. 313,996	1/1991	Mitsuse	D14/165
D. 334,385	3/1993	Imai et al.	D14/165

OTHER PUBLICATIONS

A Sharper Image® voice organizer for recording personal messages. (Undated).

A Voice IT™ memo pad for recording personal messages. (Undated).

A Flashback™ digital recorder for personal digital recordings. (Undated).

A Yak Bak™ recording device for recording personal messages. (Undated).

Primary Examiner—Terry A. Wallace

Assistant Examiner—Nanda Bondade

Attorney, Agent, or Firm—Flehr, Hohbach, Test Albritton & Herbert

[57] **CLAIM**

The ornamental design for hand held recorder with graphical display representation, as shown.

DESCRIPTION

FIG. 1 is a top perspective view of a hand held recorder with graphical display representation showing my new design;

FIG. 2 is a top plan view thereof;

FIG. 3 a side elevation view thereof;

FIG. 4 is a bottom plan view thereof;

FIG. 5 a side elevation view thereof of the side opposite to FIG. 3;

FIG. 6 is a front elevation view thereof; and,

FIG. 7 is a rear elevation view thereof.

1 Claim, 2 Drawing Sheets

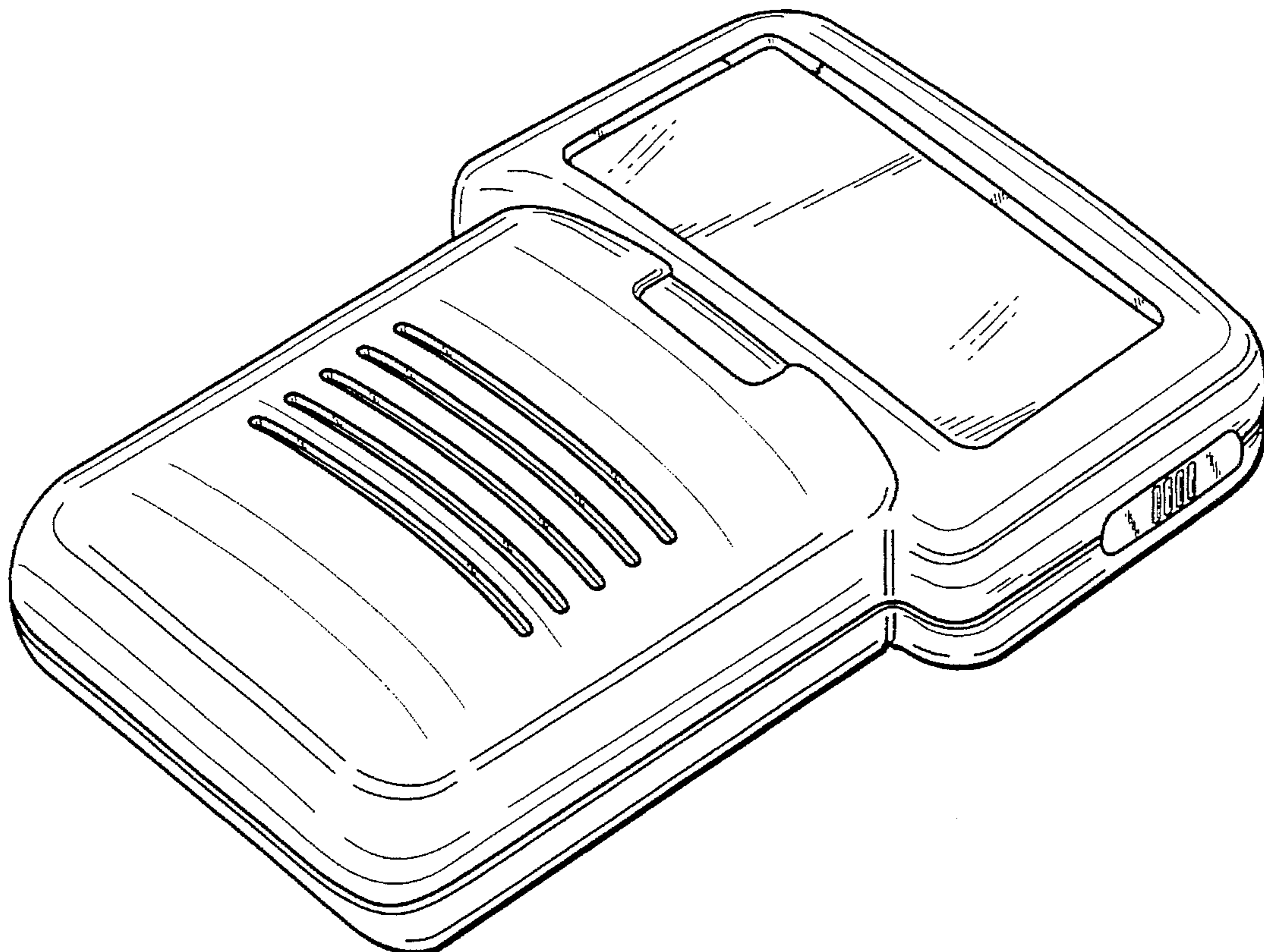

FIG. 1

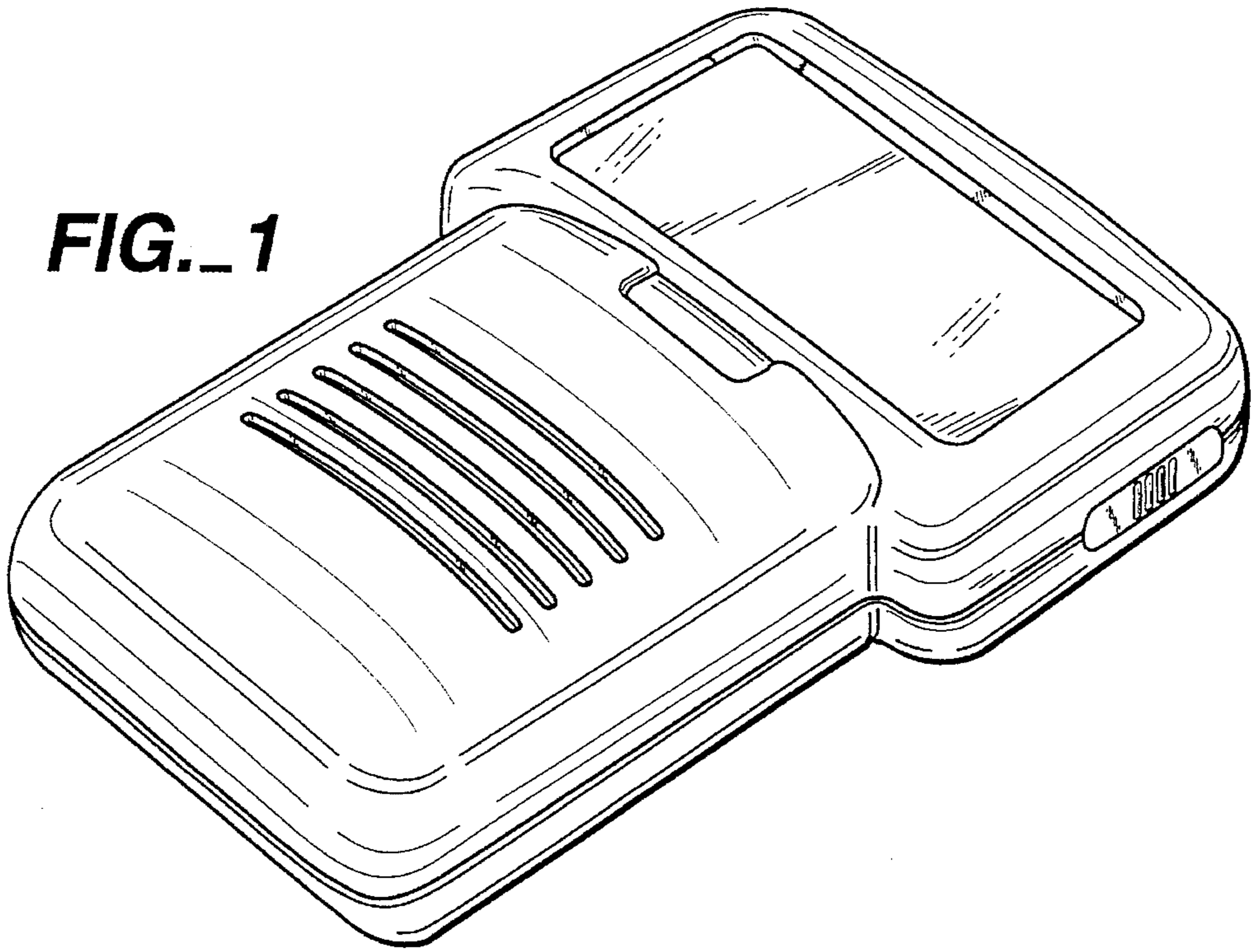
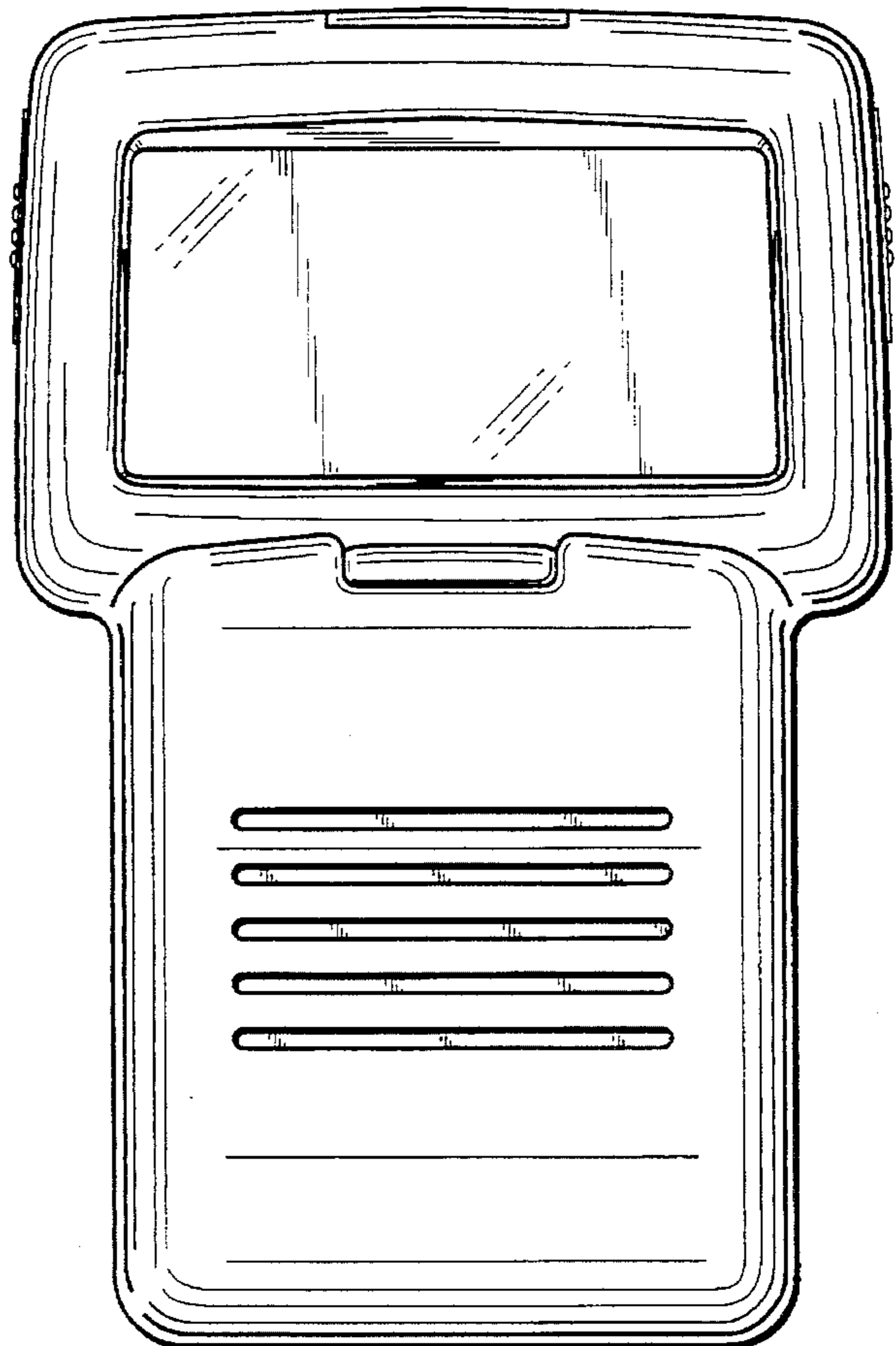

FIG. 2



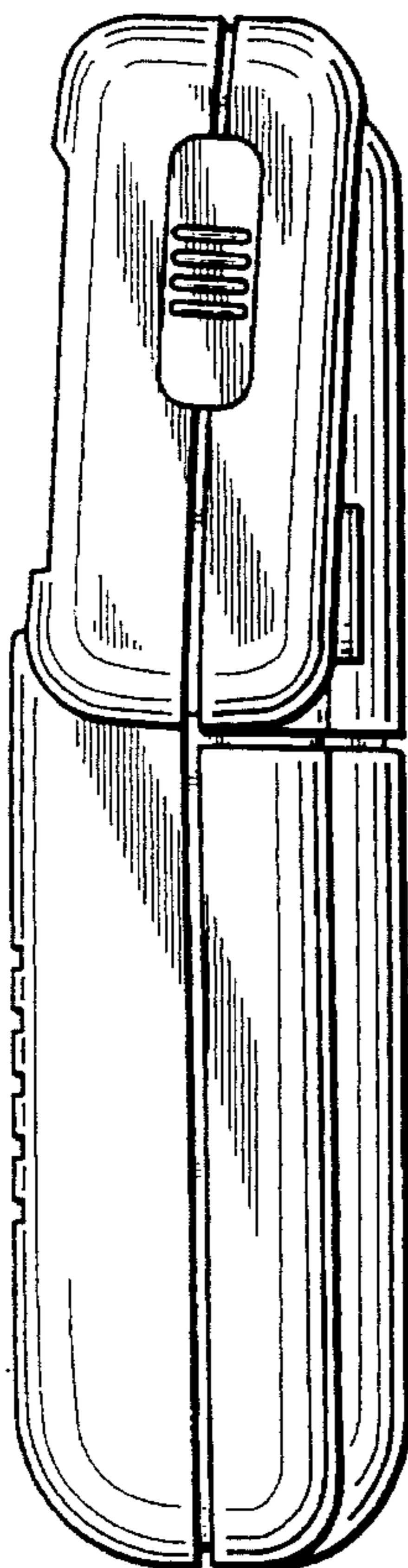

FIG._3

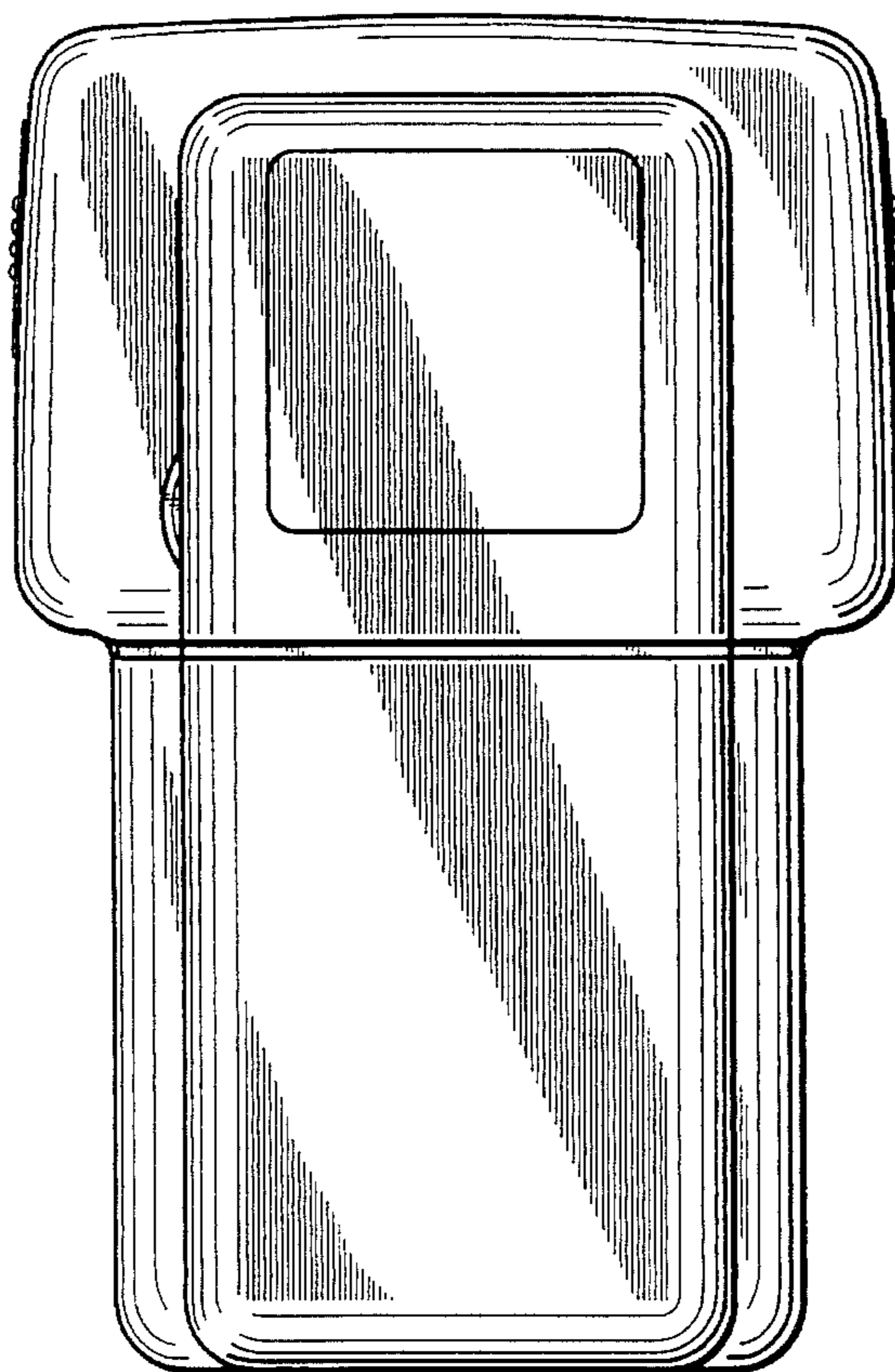

FIG._4

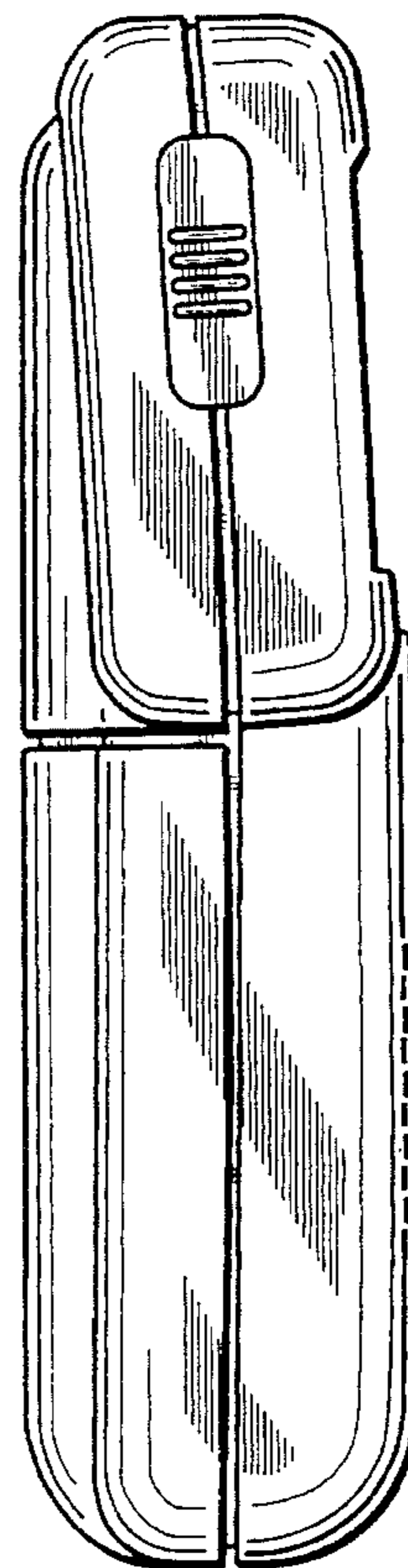

FIG._5

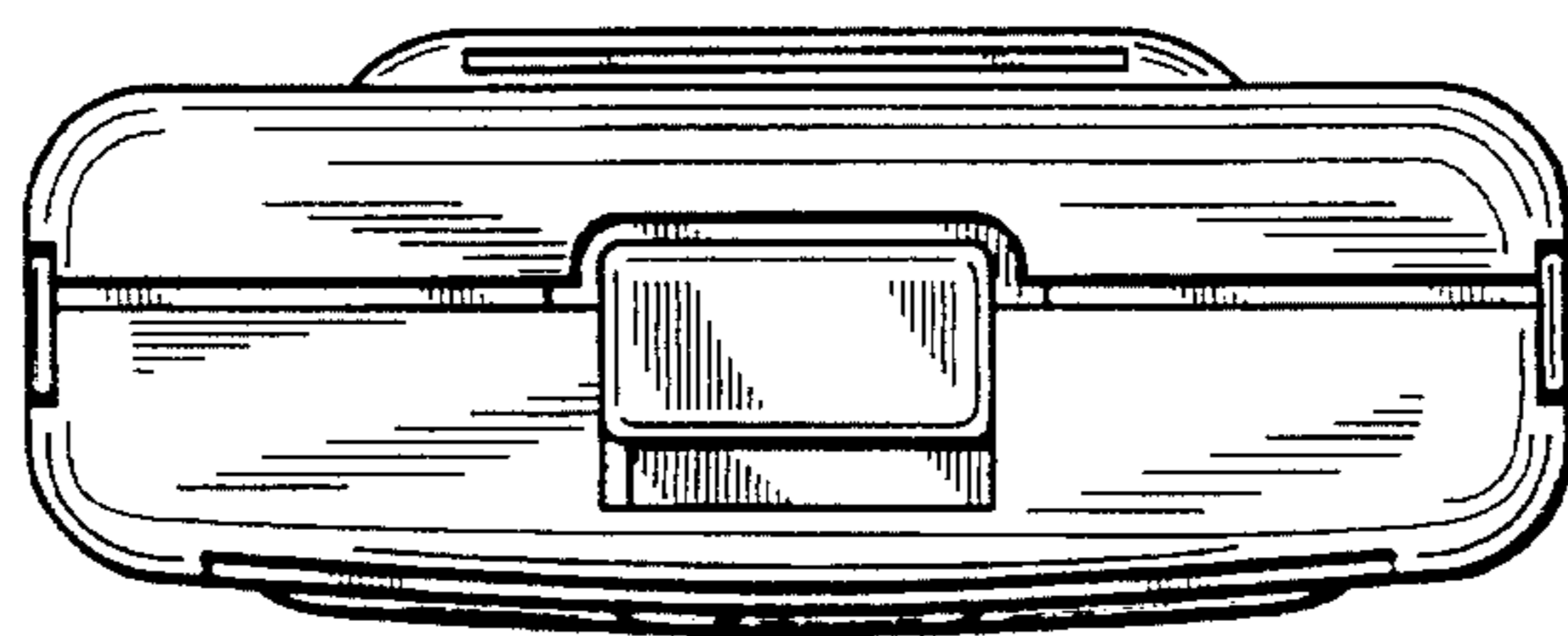

FIG._6

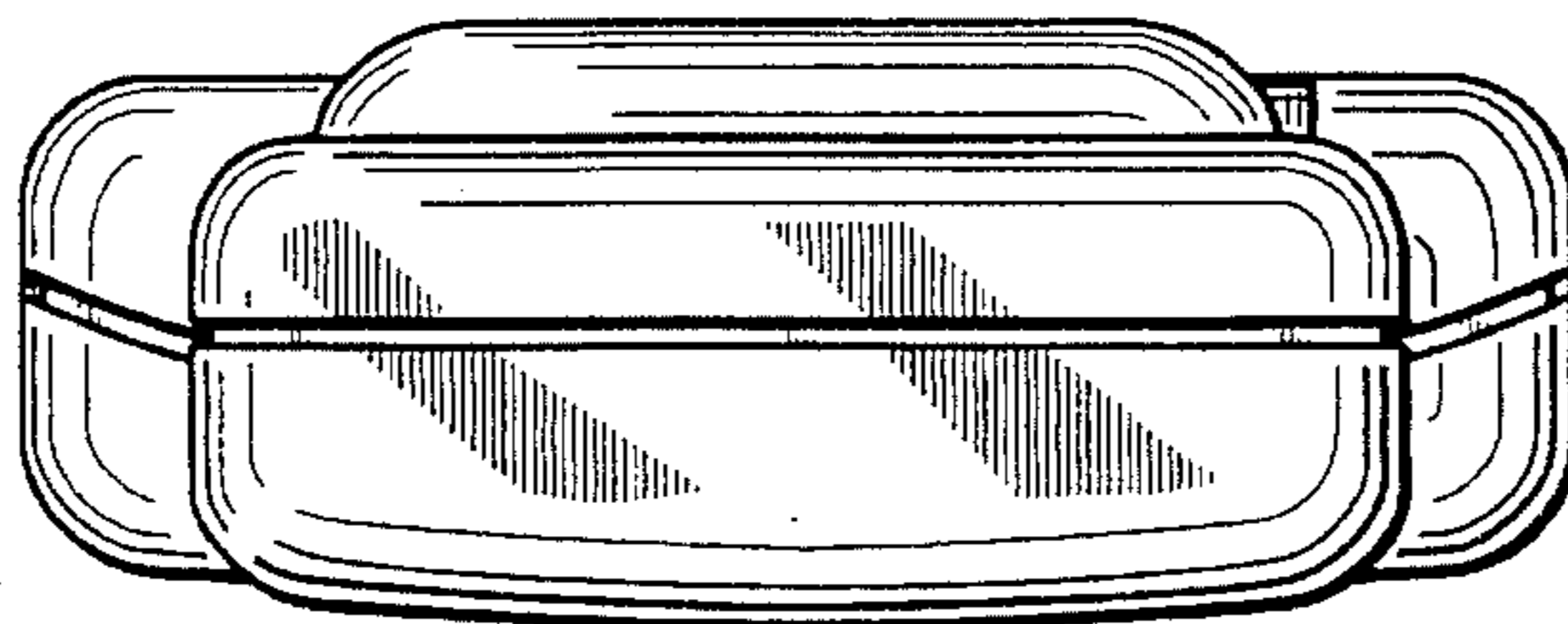

FIG._7