



US00D372627S

**United States Patent** [19]  
**Ireland**

[11] **Patent Number: Des. 372,627**

[45] **Date of Patent: \*\*Aug. 13, 1996**

[54] **COFFEE POT**

[75] Inventor: **Keith N. Ireland**, Sanderstead, England

[73] Assignee: **Household Articles Limited**, South Croydon, England

[\*\*] Term: **14 Years**

[21] Appl. No.: **42,714**

[22] Filed: **Jul. 26, 1995**

[52] U.S. Cl. .... **D7/319; D7/317; D7/316**

[58] Field of Search ..... **D7/300, 305, 306, D7/307, 312, 313, 316, 317, 318, 319, 321, 322, 608, 598; 222/190, 185.1, 465.1, 475.1**

[56] **References Cited**

**U.S. PATENT DOCUMENTS**

D. 97,663	12/1935	Ackerman	.....	D7/321
D. 115,411	6/1939	Lacy	.....	D7/300
D. 342,414	12/1993	Jorgensen	.....	D7/317
D. 343,760	2/1994	Lin	.....	D7/317 X
5,018,643	5/1991	Bolduc	.....	222/190 X

**OTHER PUBLICATIONS**

"Insta Brewer" Housewares Feb., 1974, p. 37 (Left Middle). Press Filter Coffee Maker (Right Center) By Alessi Tableware International Nov. 1986, p. 52. Coffee Pot (Bottom Left), King Yn-Hwang of Taiwan 1990.

*Primary Examiner*—M. N. Pandozzi  
*Attorney, Agent, or Firm*—Baker & Botts, L.L.P.

[57] **CLAIM**

The ornamental design for a coffee pot, as shown and described.

**DESCRIPTION**

FIG. 1 is a perspective view of a coffee pot showing my new design;  
FIG. 2 is a left side elevational view thereof, the right side being a mirror image thereof;  
FIG. 3 is a rear elevational view thereof;  
FIG. 4 is a front elevational view thereof;  
FIG. 5 is a top plan view thereof; and,  
FIG. 6 is a bottom view thereof.

**1 Claim, 5 Drawing Sheets**

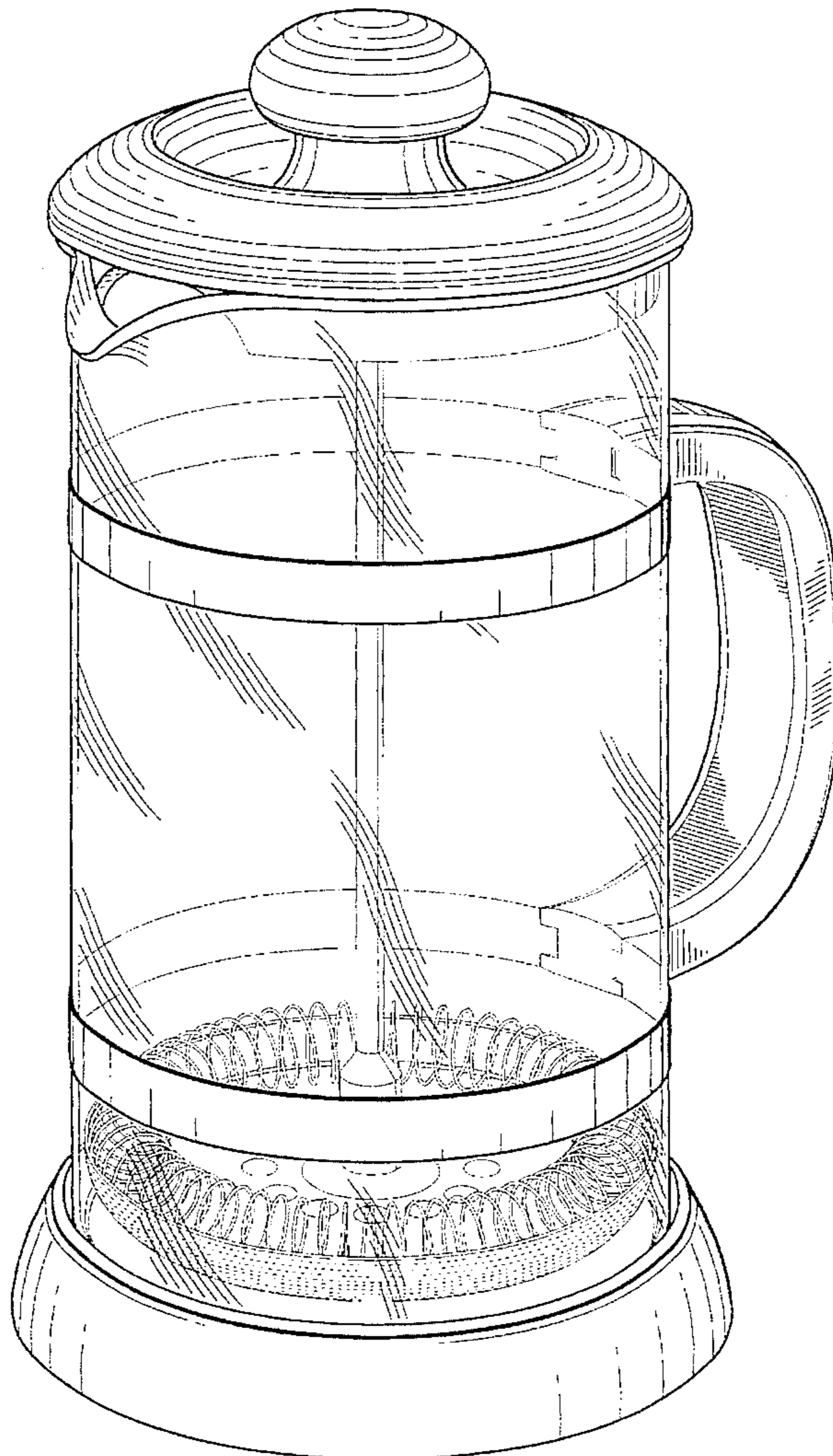

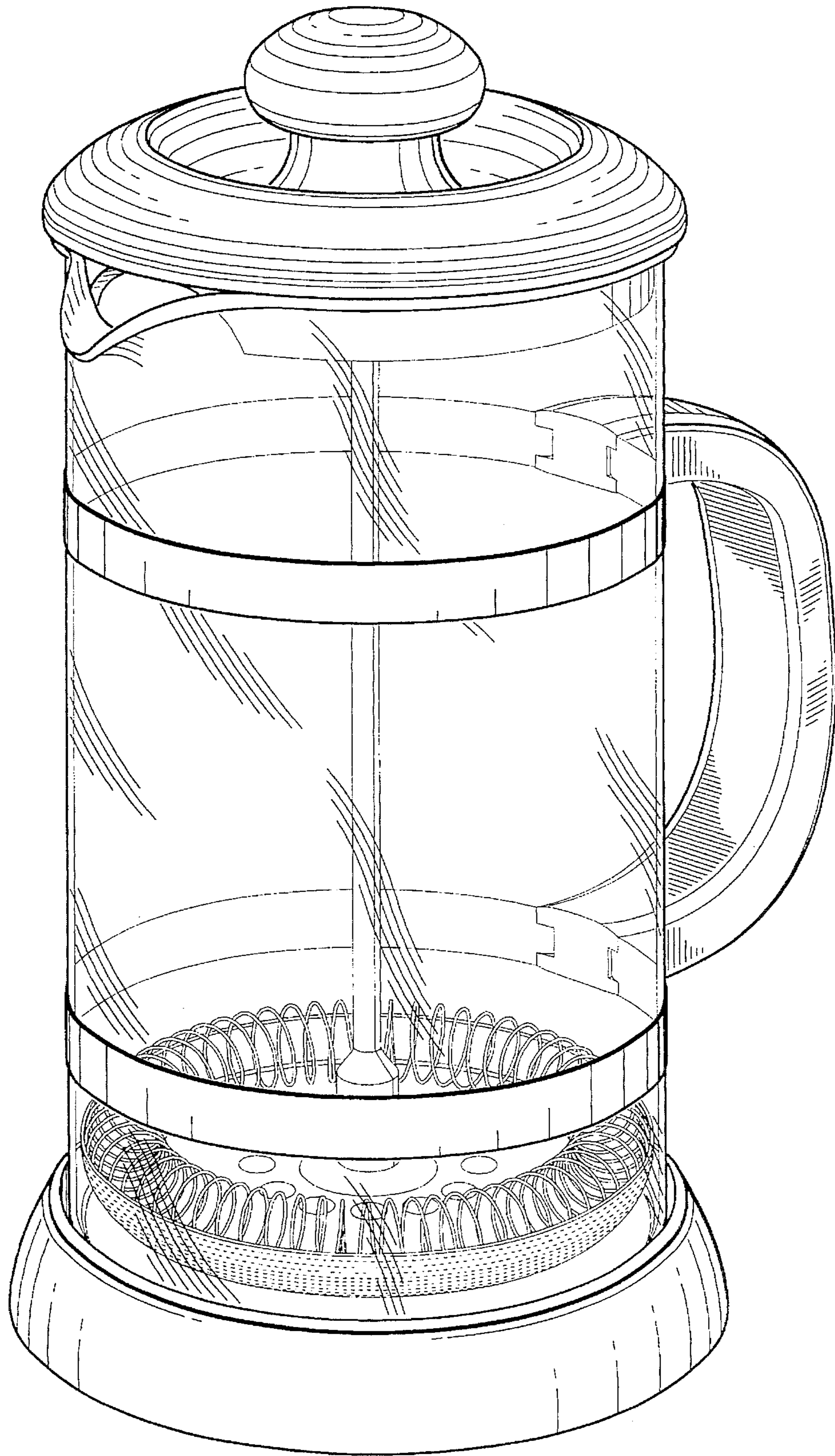

FIG. 1

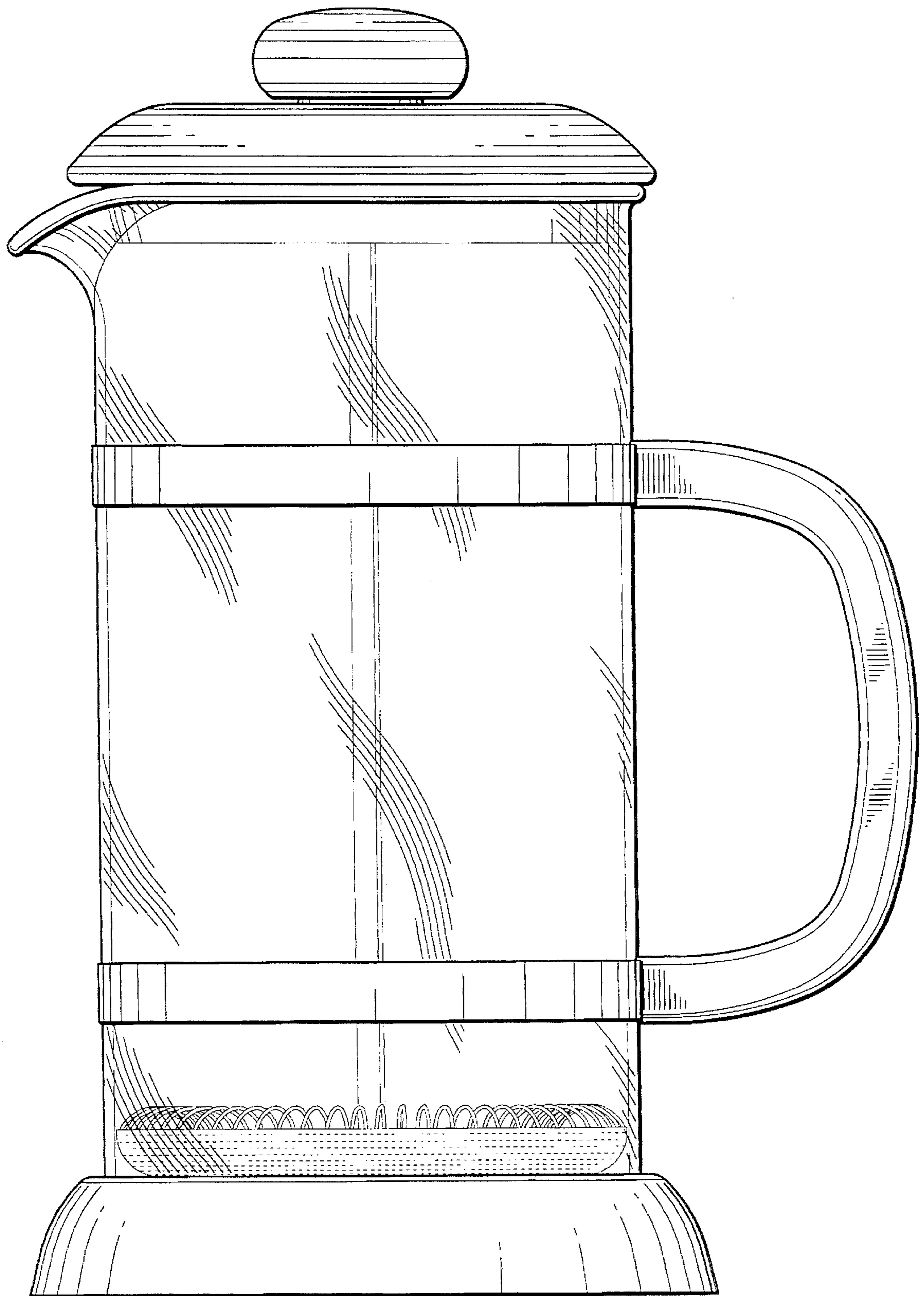

FIG. 2

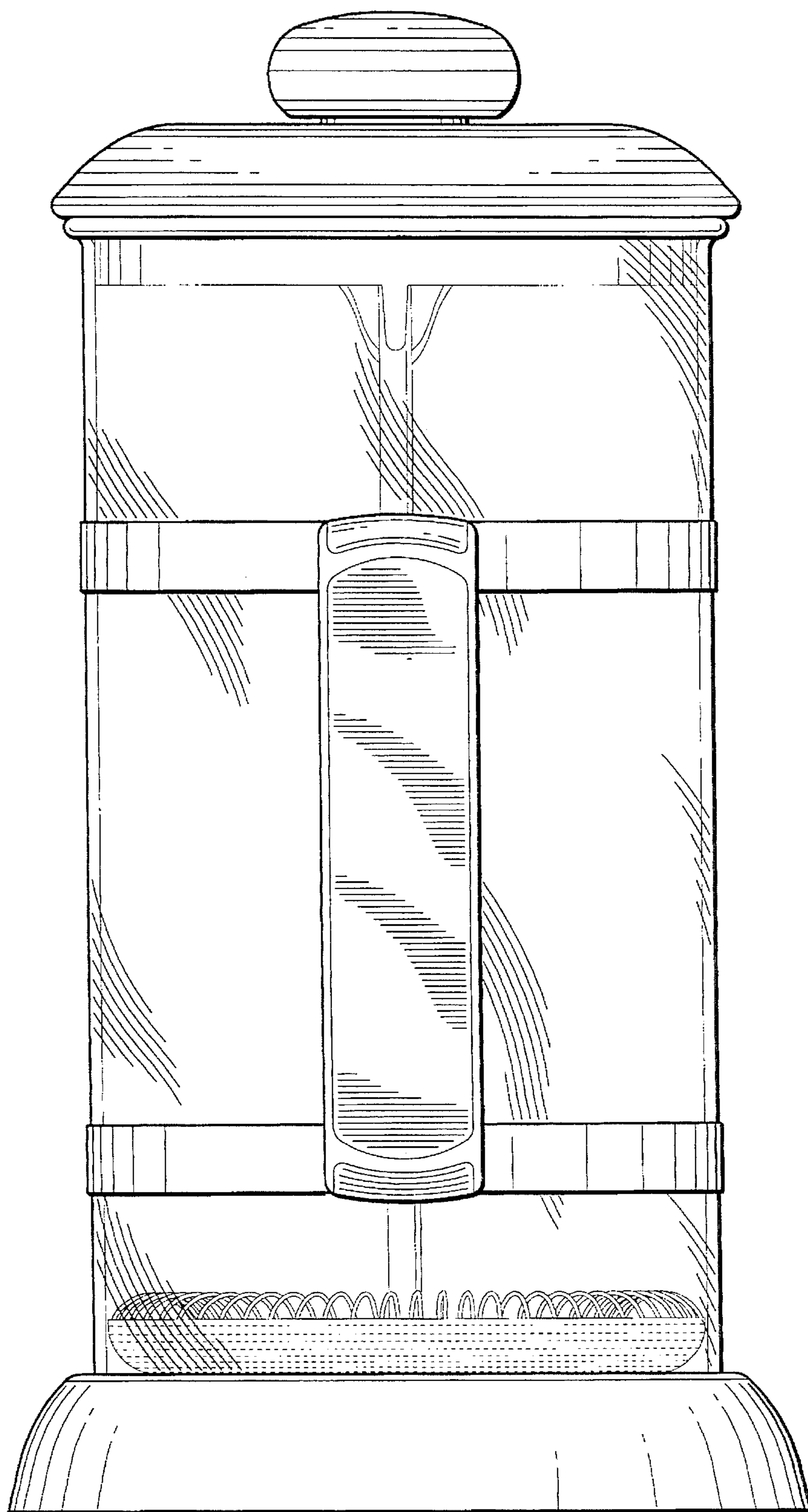

FIG. 3

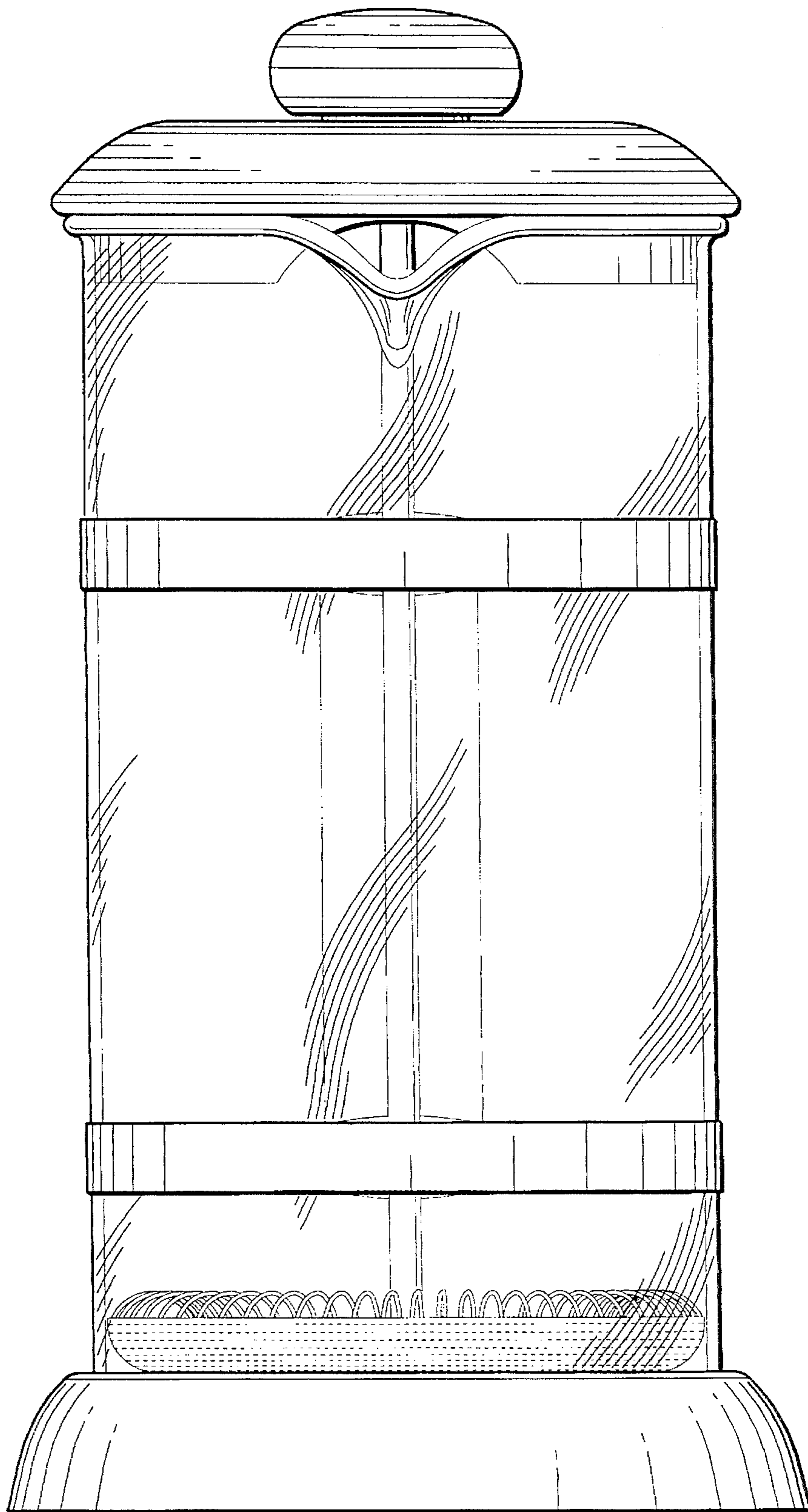

FIG. 4

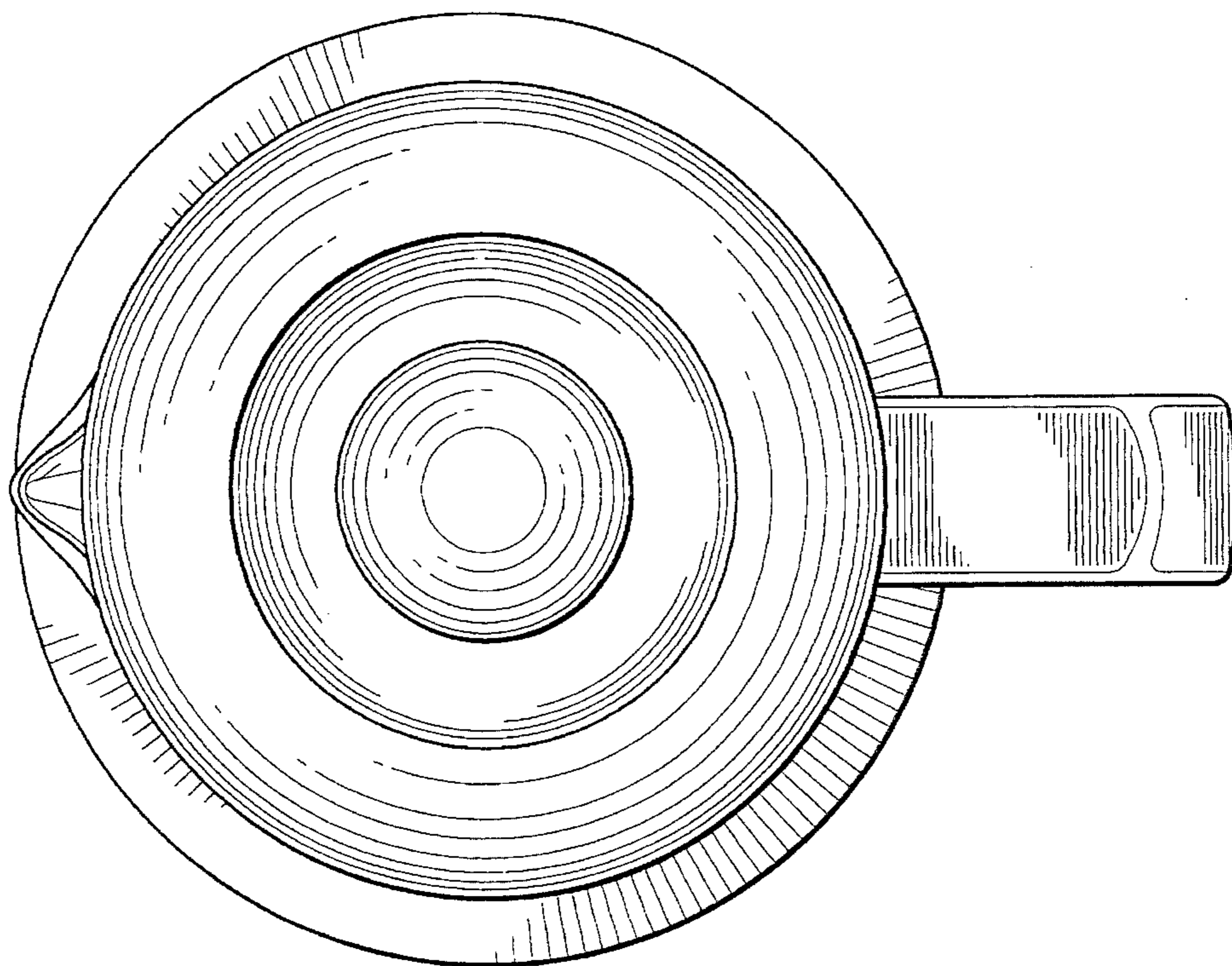

FIG. 5

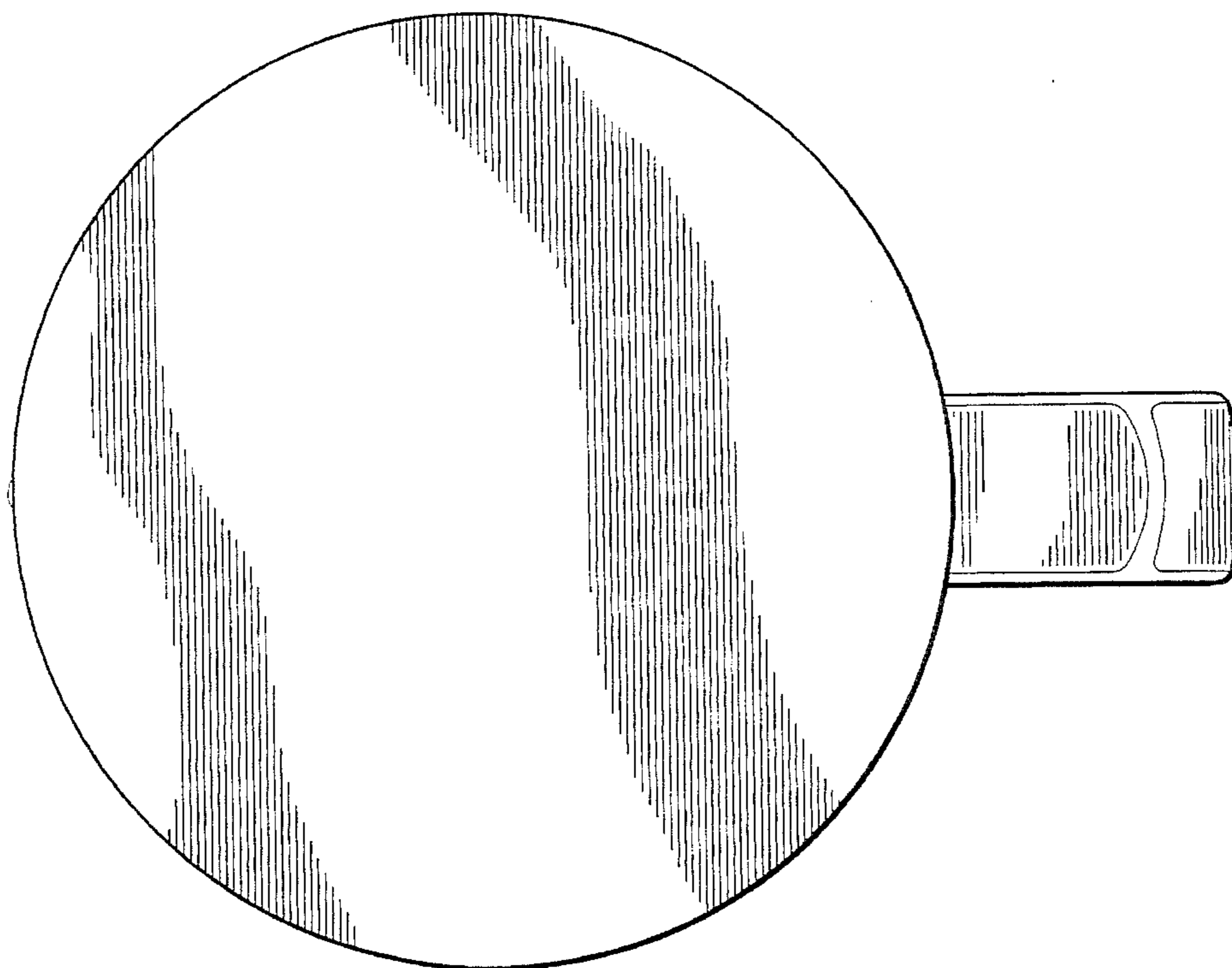

FIG. 6