



US00D372619S

United States Patent [19]

[11] Patent Number: **Des. 372,619**

Palka

[45] Date of Patent: ****Aug. 13, 1996**

[54] WALL LINEN CABINET

[76] Inventor: **James J. Palka**, 22351 W. Thornridge Dr., Kildeer, Ill. 60047

[**] Term: **14 Years**

[21] Appl. No.: **44,232**

[22] Filed: **Sep. 21, 1995**

[52] U.S. Cl. **D6/561**

[58] Field of Search D6/559-561; 312/34.1, 312/34.4, 100, 101, 114, 138.1, 245

[56] References Cited

U.S. PATENT DOCUMENTS

D. 251,166	2/1979	McIntosh	D6/560
D. 260,953	9/1981	Patterson	D6/561
D. 290,433	6/1987	Nusz	D6/559 X
D. 313,523	1/1991	Grey	D6/561 X

Primary Examiner—Brian N. Vinson

Attorney, Agent, or Firm—August E. Roehrig, Jr.

[57] CLAIM

The ornamental design for a wall linen cabinet, as shown and described.

DESCRIPTION

FIG. 1 is a frontal perspective view of a wall linen cabinet

showing my new design;

FIG. 2 is a front elevational view of a wall linen cabinet showing my new design;

FIG. 3 is a right side elevational view, the left side elevational view is a mirror image thereof;

FIG. 4 is a top plan view;

FIG. 5 is a bottom plan view;

FIGS. 6, 7, 8 and 9 are enlarged fragmentary cross-sectional views showing portions of the cabinet taken along lines 6-6, 7-7, 8-8 and 9-9, respectively, to better illustrate the contours thereof;

FIG. 10 is an enlarged fragmentary view of a portion of the cabinet header taken in the direction of lines 10-10 of FIG. 6 to illustrate the appearance thereof;

FIG. 11 is an enlarged broken profile view of a cabinet door to better illustrate the contour thereof;

FIG. 12 is a cross-sectional view of FIG. 11 taken along lines 12-12 to better illustrate the contour thereof; and,

FIG. 13 is an enlarged fragmentary view of a portion of the pilasters of the cabinet to better illustrate the appearance thereof.

The undisclosed rear of the wall linen cabinet is unadorned and is not seen when the linen cabinet is in place.

1 Claim, 4 Drawing Sheets

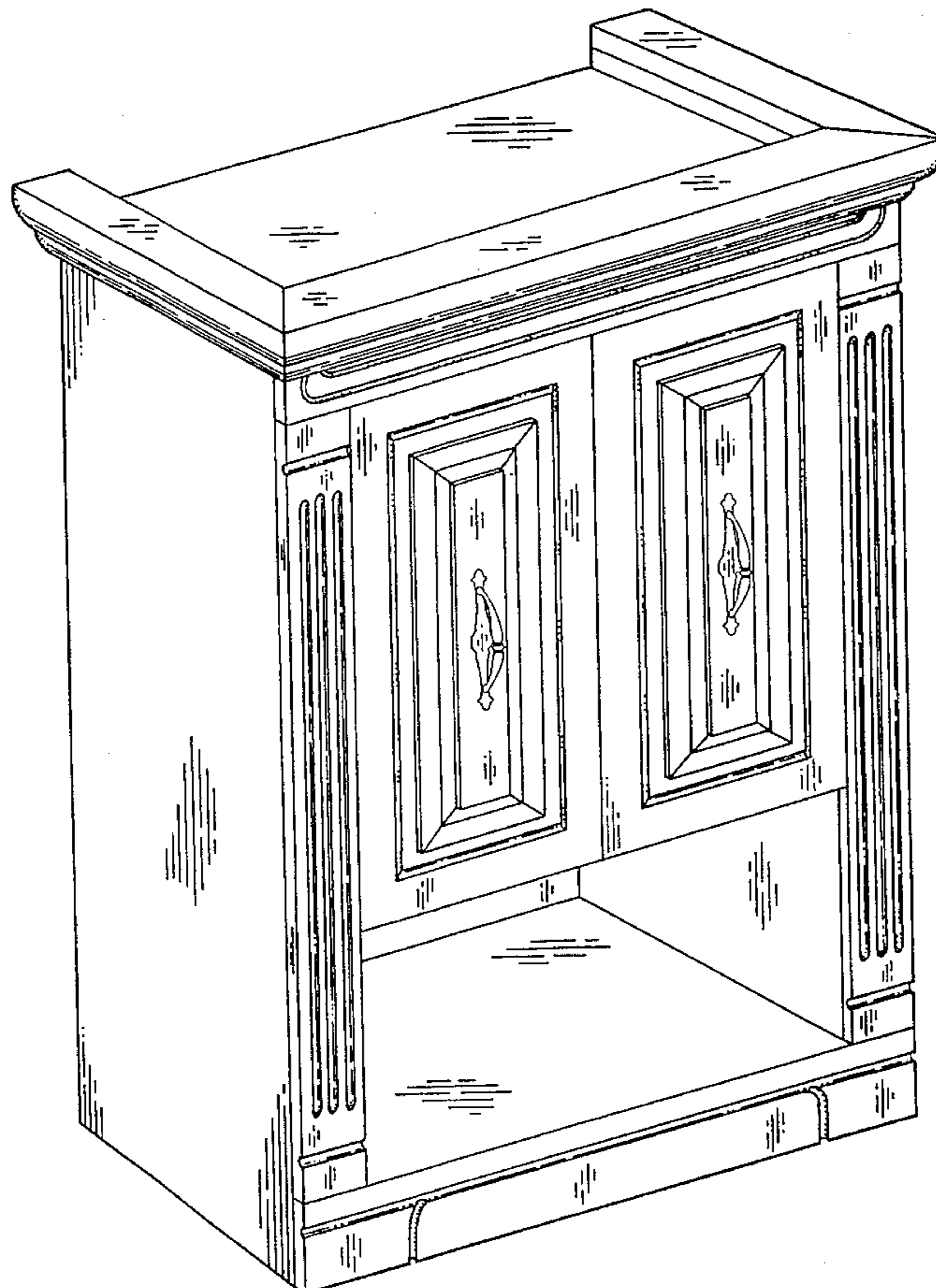

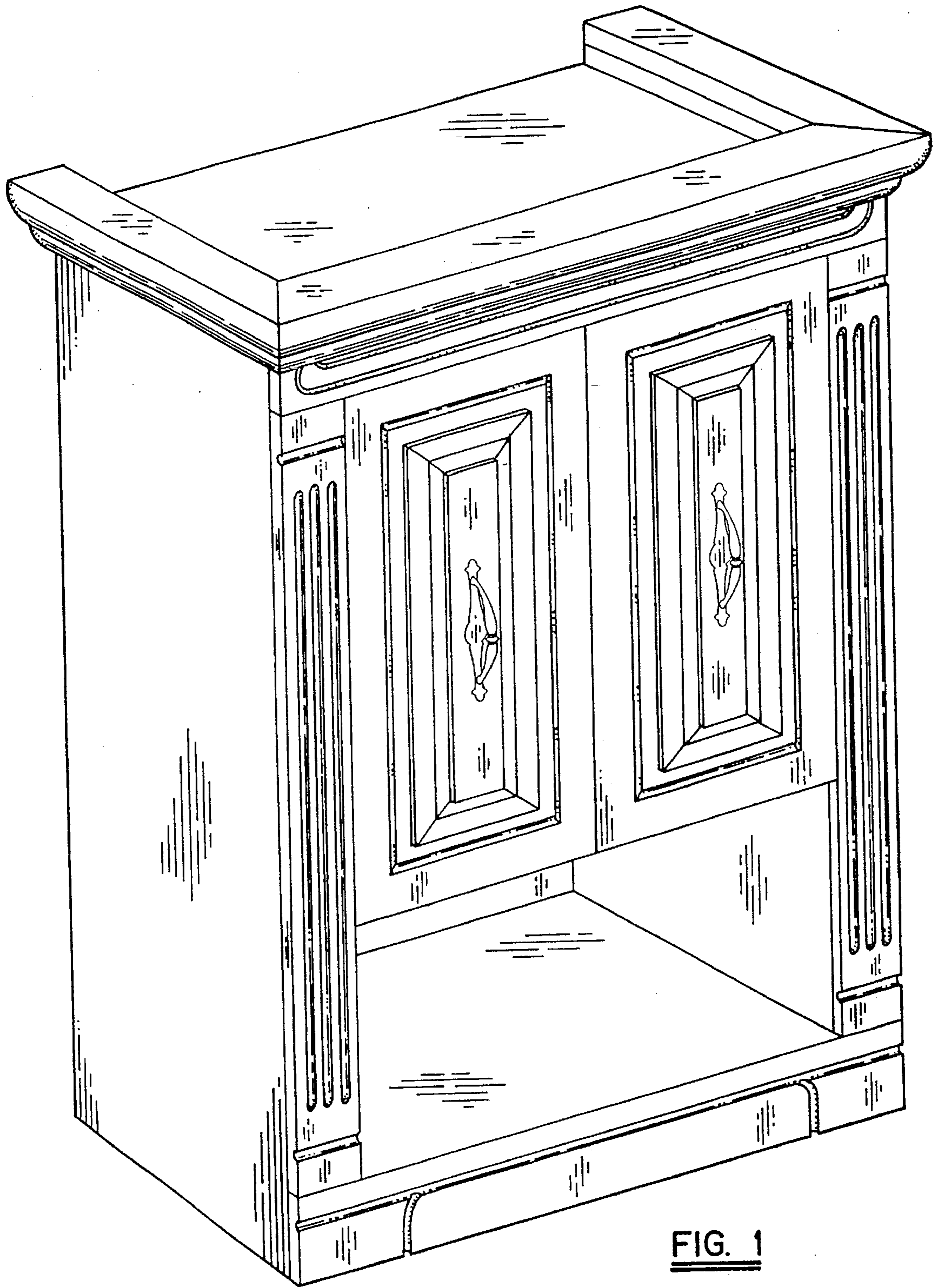

FIG. 1

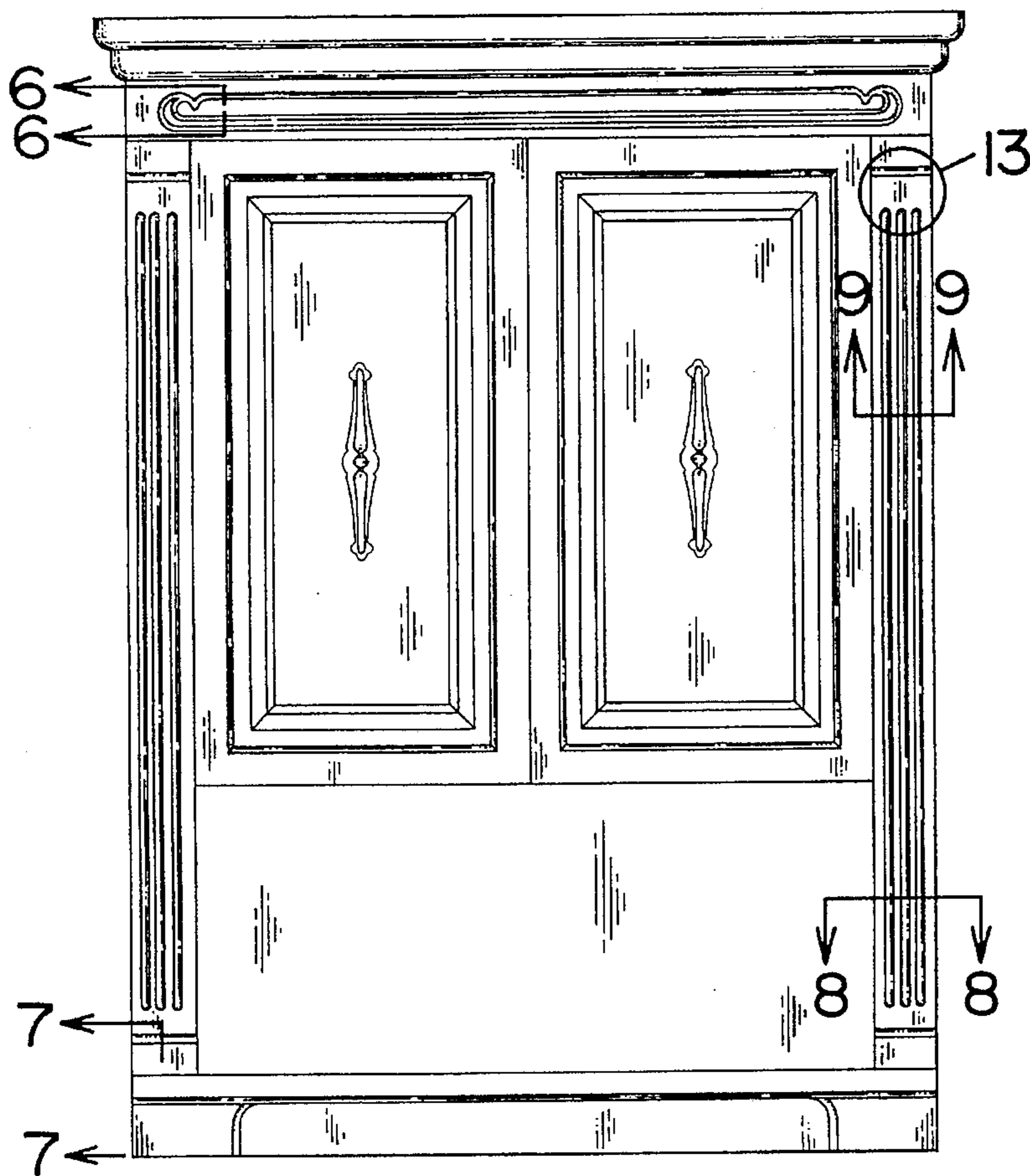

FIG. 2

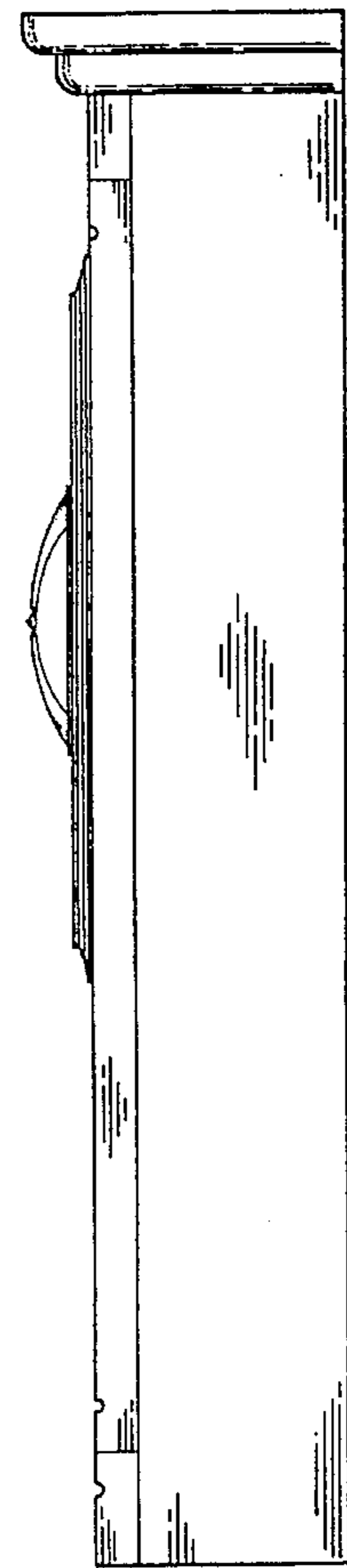

FIG. 3

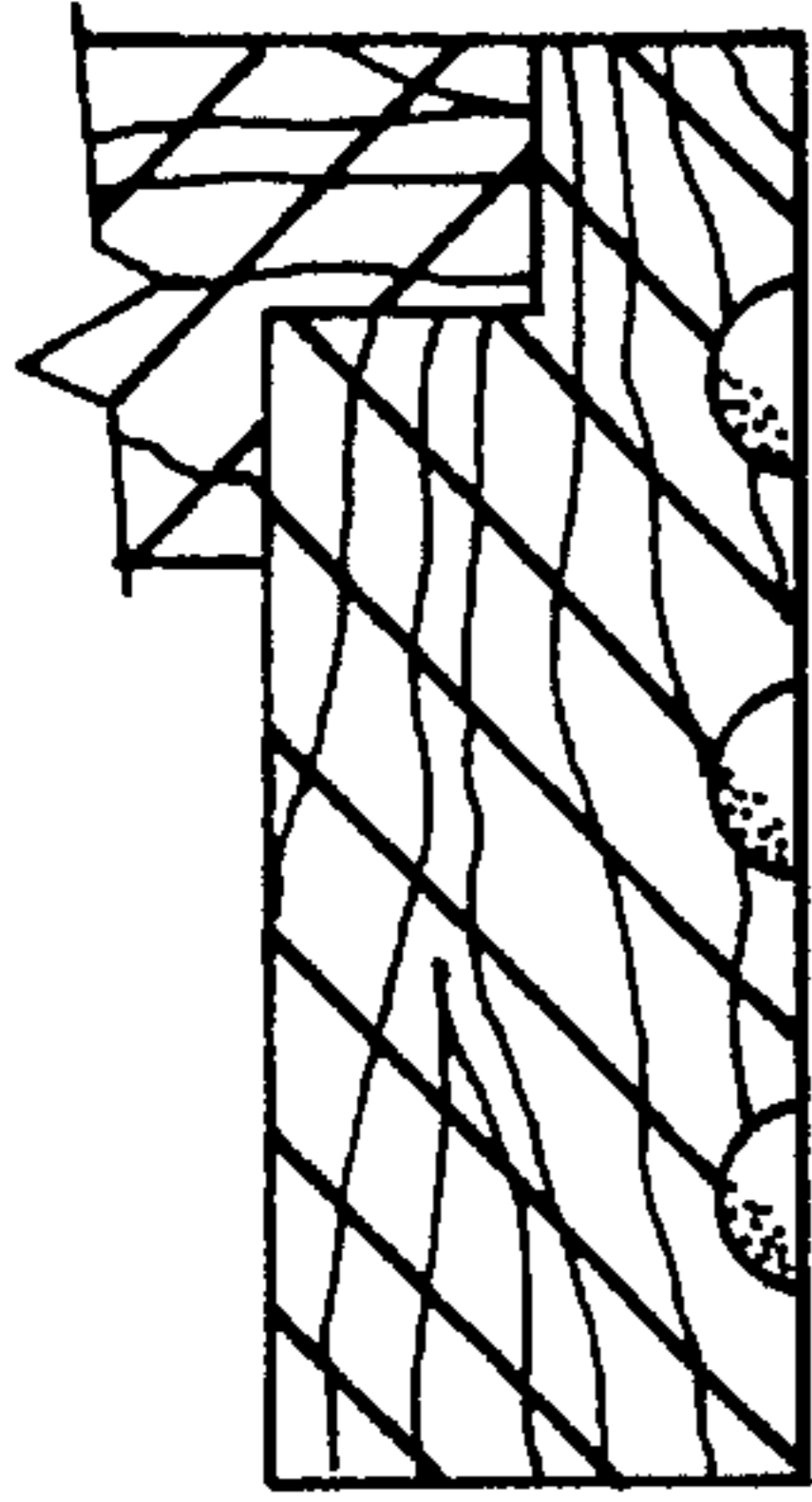

FIG. 8

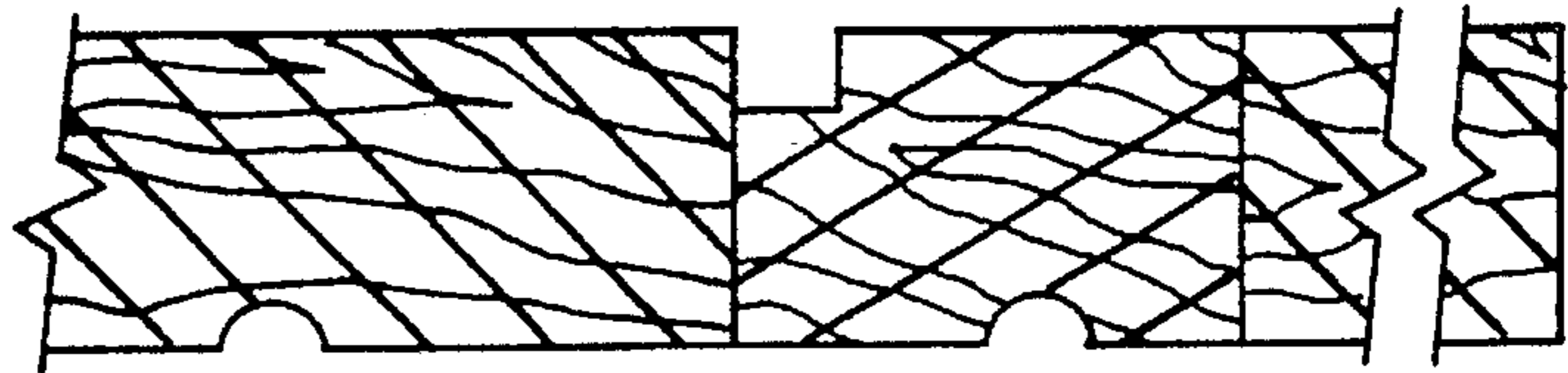

FIG. 7

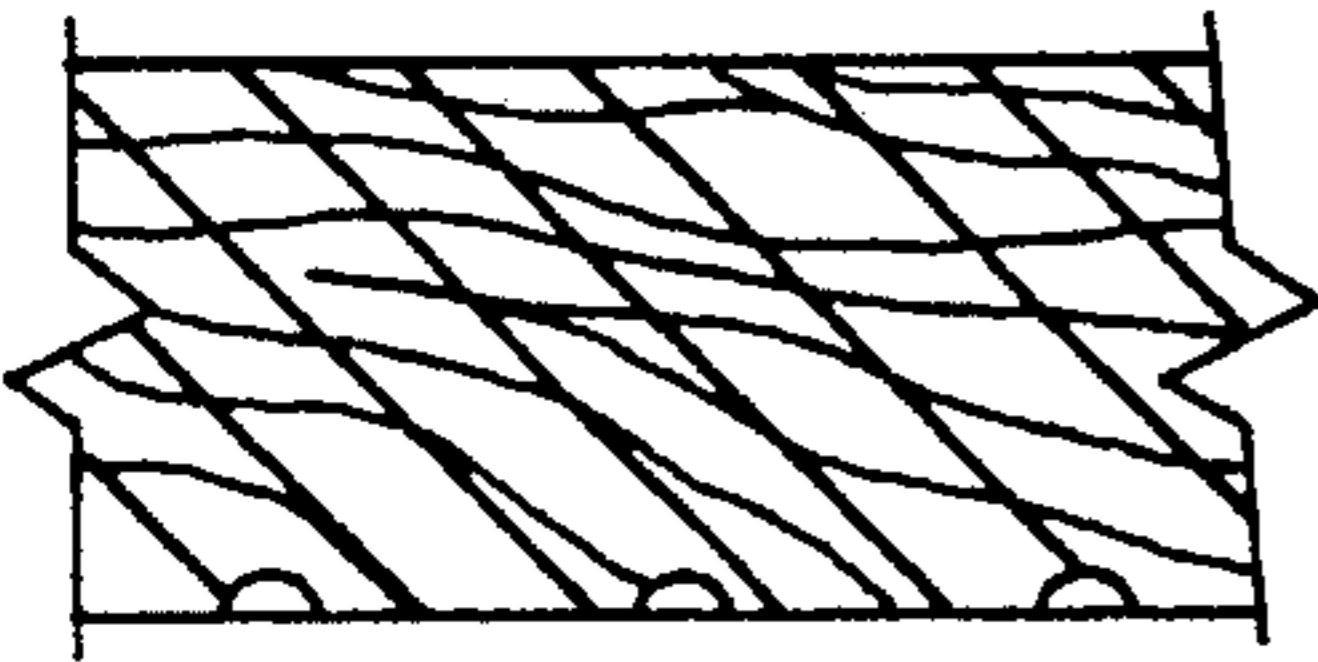

FIG. 6

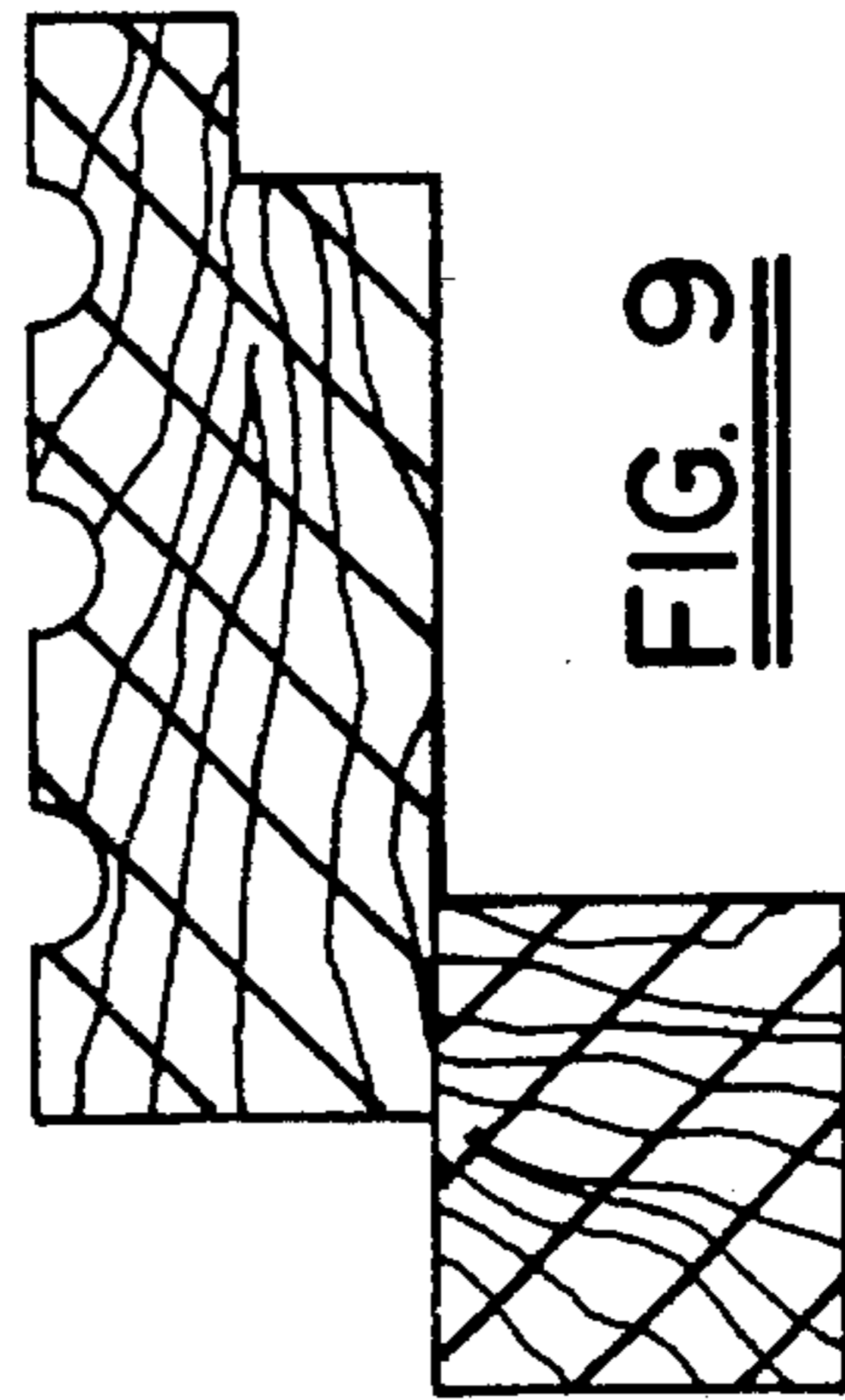

FIG. 9

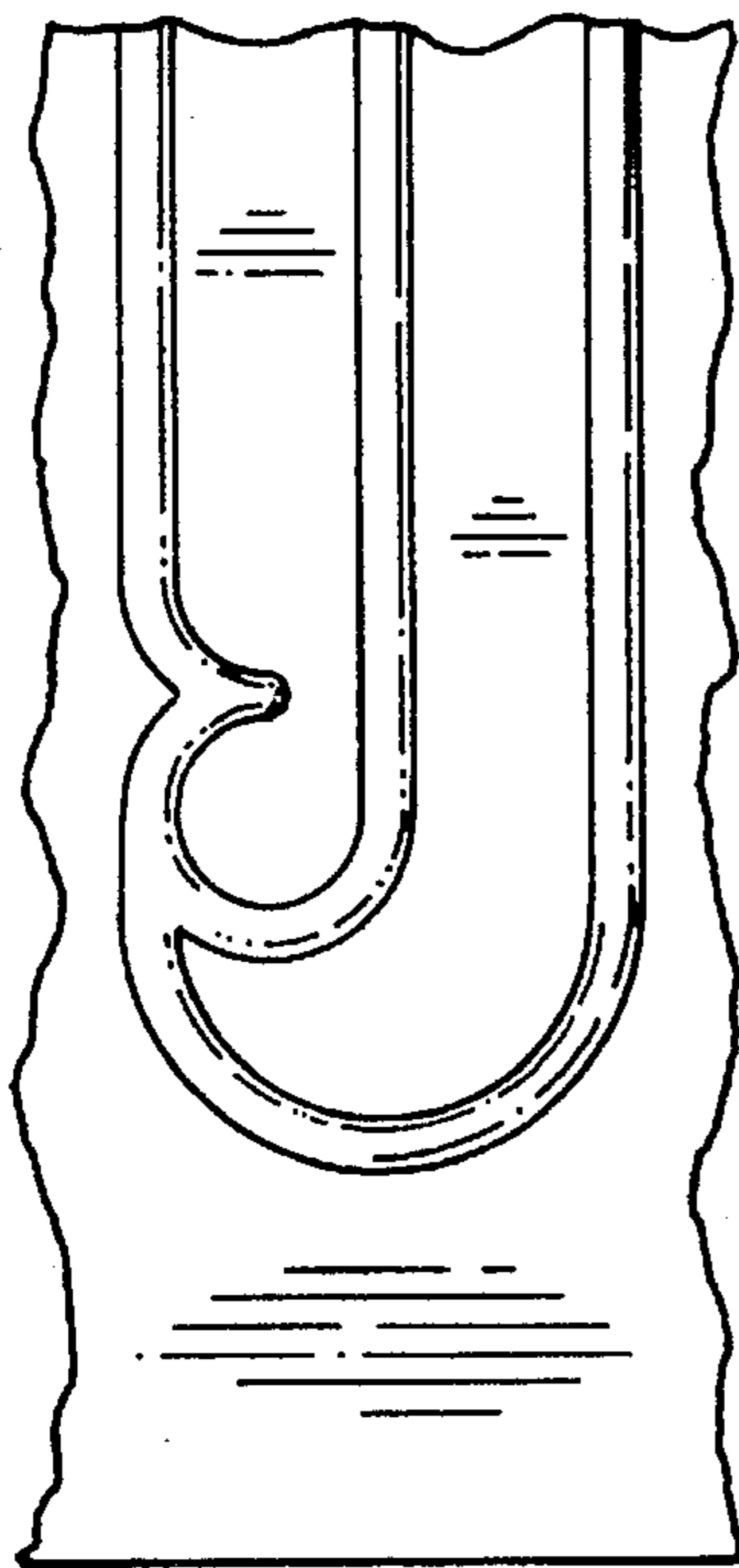

FIG. 10

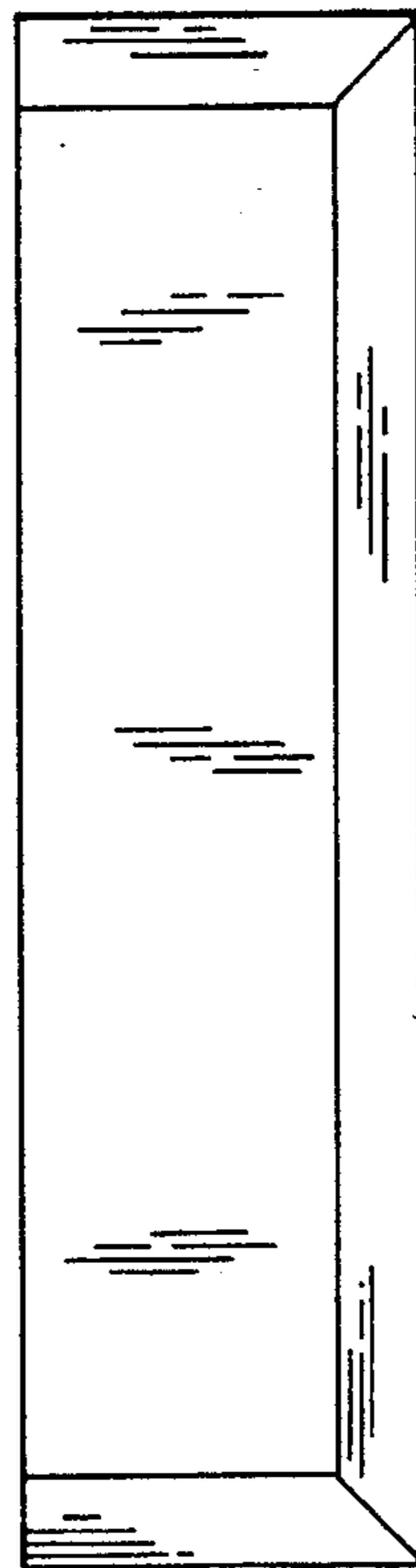

FIG. 4

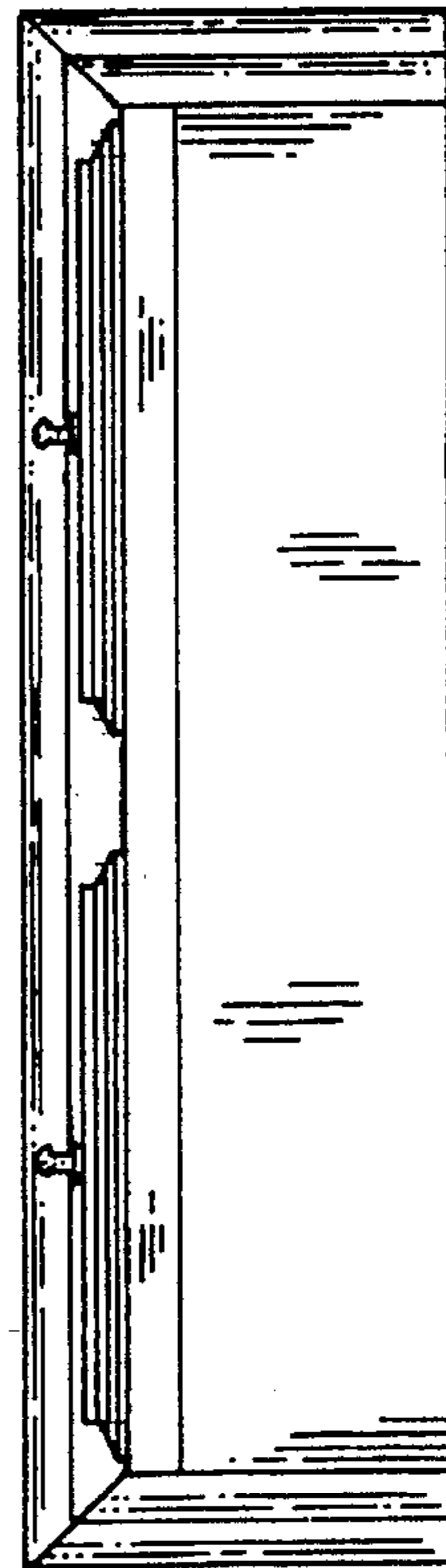

FIG. 5

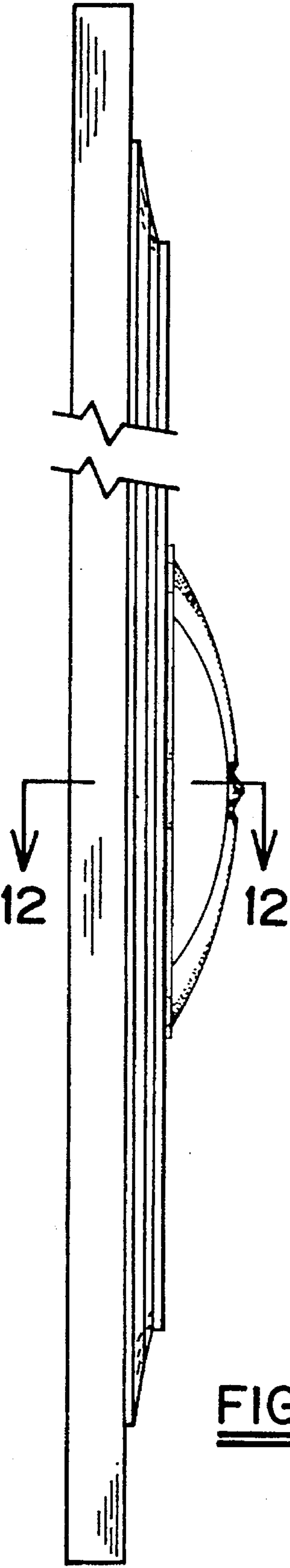

FIG. 11

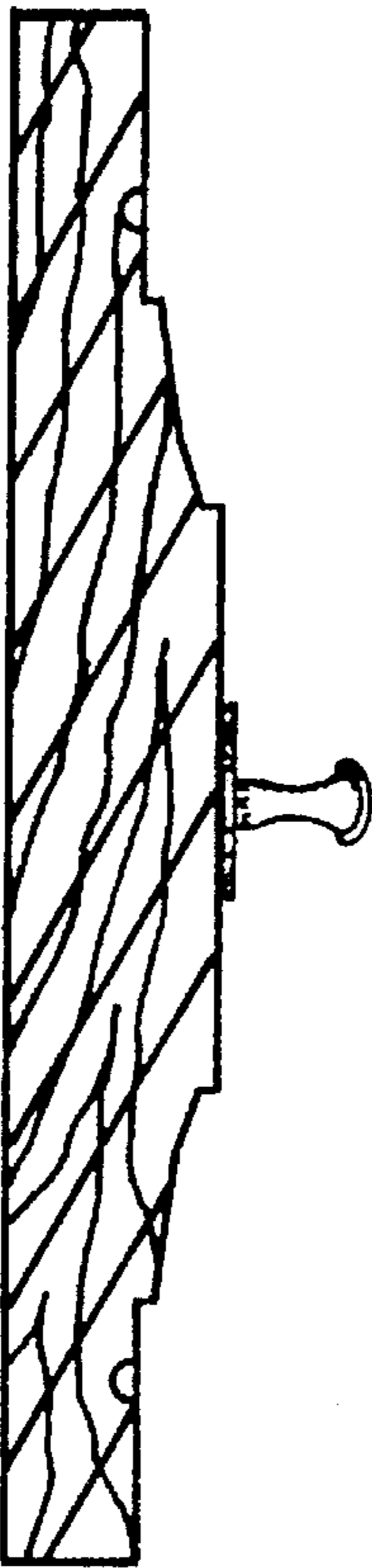

FIG. 12

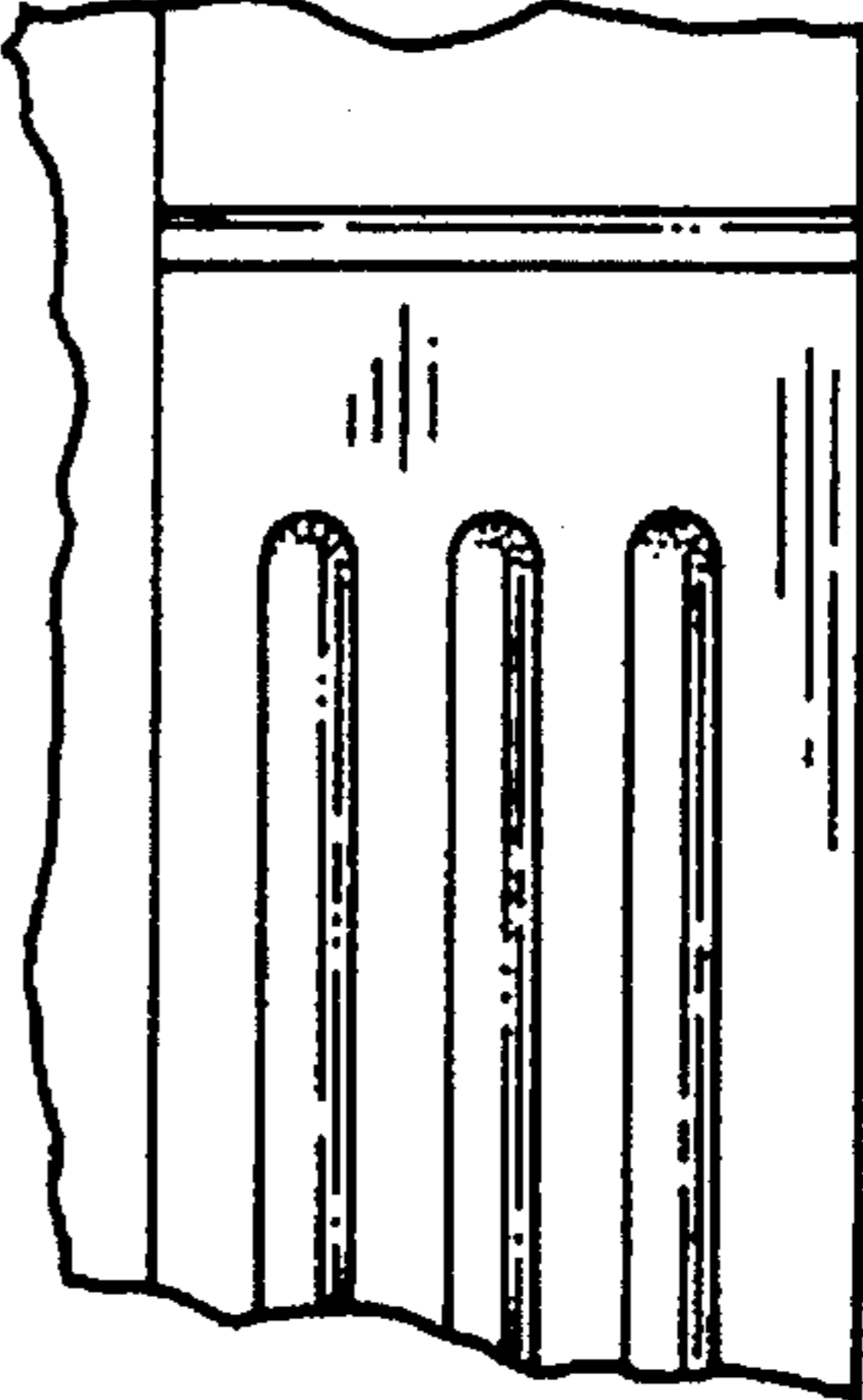

FIG. 13