



US00D372531S

United States Patent [19]

[11] Patent Number: **Des. 372,531**

MacAuley et al.

[45] Date of Patent: ***** Aug. 6, 1996**

[54] **COMBINED BOTTLE AND CAP**

4,747,519	10/1985	Green et al.	222/181
4,934,545	6/1990	Pezzoli et al.	215/250
4,951,845	8/1990	Pezzoli et al.	215/250
5,123,554	6/1992	Arvidson	215/12.2

[75] Inventors: **Richard P. MacAuley**, Westerville; **Patrick E. McCallister**, Columbus, both of Ohio; **Jay A. Smithberger**, Evanston, Ill.; **Lewis H. Sita**, Worthington; **Elwood L. Stokesbury**, Westerville, both of Ohio

Primary Examiner—Louis S. Zarfaz
Assistant Examiner—I. Simmons
Attorney, Agent, or Firm—Brian R. Woodworth

[73] Assignee: **Abbott Laboratories**, Abbott Park, Ill.

[57] **CLAIM**

[*] Notice: The portion of the term of this patent subsequent to Jul. 23, 2010, has been disclaimed.

The ornamental design for a combined bottle and cap, as shown and described.

[**] Term: **14 Years**

DESCRIPTION

[21] Appl. No.: **26,132**

FIG. 1 is a perspective view of a first embodiment of a combined bottle and cap showing our new design; FIG. 2 is a front elevation thereof, the rear elevation being a mirror image of said front elevation; FIG. 3 is a top view thereof; FIG. 4 is a bottom view thereof; FIG. 5 is a first side elevation thereof; and FIG. 6 is a second side elevation thereof for the side opposite that shown in FIG. 5; FIG. 7 is a perspective view of a second embodiment of a combined bottle and cap showing our new design; FIG. 8 is a front elevation thereof, the rear elevation being a mirror image of said front elevation; FIG. 9 is a top view thereof; FIG. 10 is a bottom view thereof; FIG. 11 is a first side elevation thereof; and FIG. 12 is a second side elevation thereof, for the side opposite that shown in FIG. 11; FIG. 13 is a perspective view of a third embodiment of a combined bottle and cap showing our new design; FIG. 14 is a front elevation thereof, the rear elevation being the same; FIG. 15 is a top view thereof; FIG. 16 is a bottom view thereof; and FIG. 17 is a side elevation thereof, the opposite side elevation being the same; FIG. 18 is a perspective view of a fourth embodiment of a combined bottle and cap showing our new design; FIG. 19 is a front elevation thereof, the rear elevation being a mirror image of said front elevation; FIG. 20 is a top view thereof; FIG. 21 is a bottom view thereof;

[22] Filed: **Jul. 20, 1994**

[52] U.S. Cl. **D24/121; D9/520; D24/222**

[58] **Field of Search** D24/121, 118, D24/224, 108, 127, 128; D9/520, 572, 573, 453, 454, 445, 447; 215/1 R, 1 C

[56] **References Cited**

U.S. PATENT DOCUMENTS

D. 203,795	4/1982	Pagels	D24/121 X
D. 288,293	2/1987	Arvans	D9/370
D. 289,975	5/1987	Wendt	D9/401
D. 302,305	7/1989	Fuller	D24/118
D. 303,496	9/1989	Larson	D9/367
D. 304,805	11/1989	Mednis	D9/341
D. 306,206	2/1990	Hargrove et al.	D24/224 X
D. 313,177	12/1990	Larson	D9/370
D. 316,965	5/1991	Arvidson	D9/370
D. 322,214	12/1991	Davis	D24/118 X
D. 330,332	10/1992	Pezzoli et al.	D9/435
3,096,913	7/1963	Corley	222/183
3,171,412	3/1965	Braun	123/272
3,325,031	6/1967	Singier	215/37
3,384,258	5/1968	Singier	215/100
3,405,723	10/1968	Jellies	D24/118 X
3,537,498	11/1970	St. Amand	150/0.5
3,581,928	6/1971	St. Amand	215/100 A
3,904,060	9/1975	McPhee	D24/121 X
3,926,341	11/1973	Lhoest	222/92
4,013,187	3/1977	Betka	215/100

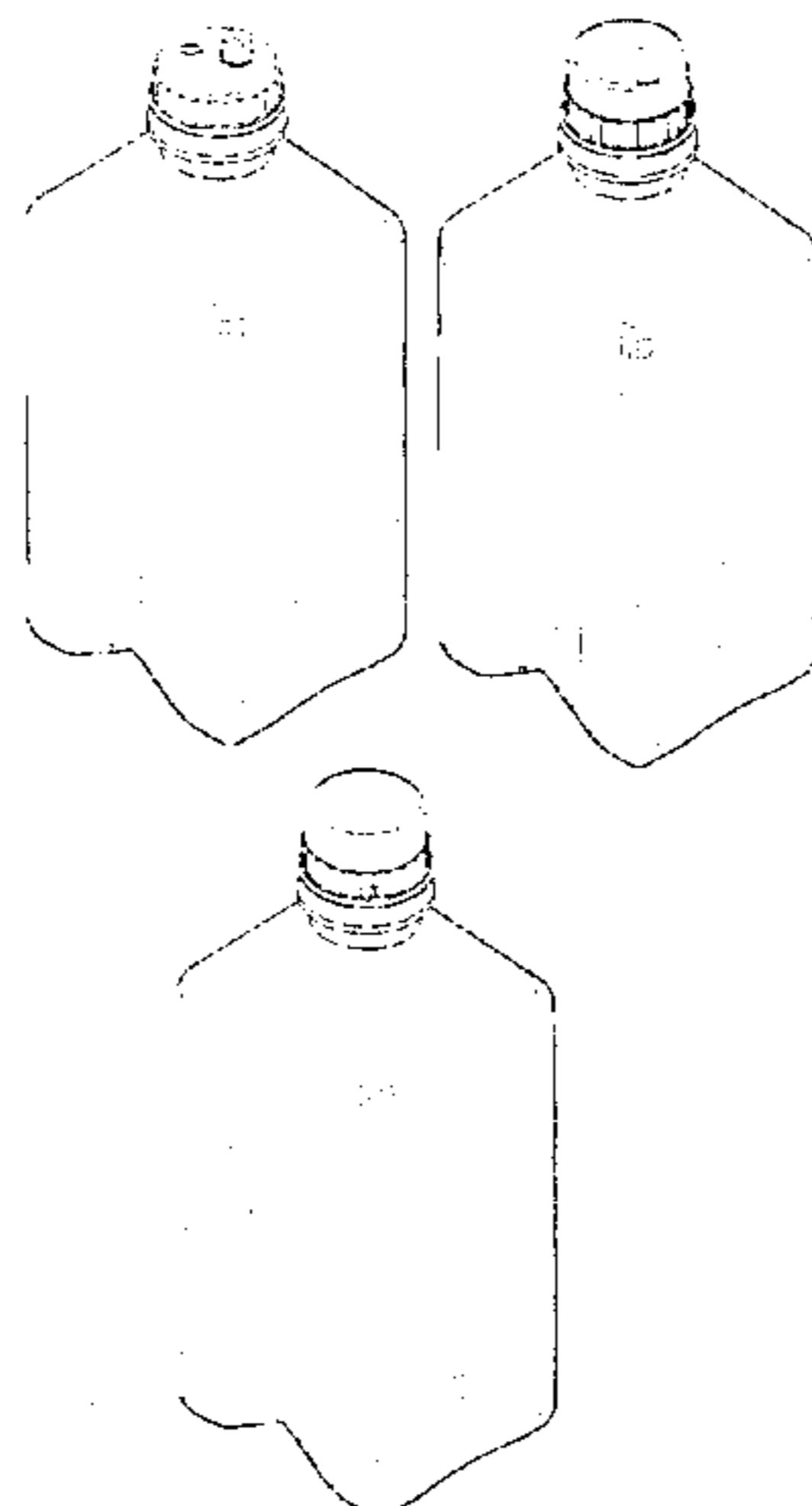

FIG. 22 is a first side elevation thereof; and
FIG. 23 is a second side elevation thereof for the side opposite that is shown in FIG. 22;
FIG. 24 is a perspective view of a fifth embodiment of a combined bottle and cap showing our new design;
FIG. 25 is a front elevation thereof, the rear elevation being a mirror image of said front elevation;
FIG. 26 is a top view thereof;
FIG. 27 is a bottom view thereof;
FIG. 28 is a first side elevation thereof; and
FIG. 29 is a second side elevation thereof for the side opposite that shown in FIG. 28;

FIG. 30 is a perspective view of an sixth embodiment of a combined bottle and cap showing our new design;
FIG. 31 is a front elevation thereof, the rear elevation being the same;
FIG. 32 is the top view thereof;
FIG. 33 is a bottom view thereof; and,
FIG. 34 is a side elevation thereof, the opposite side elevation being the same.

1 Claim, 16 Drawing Sheets

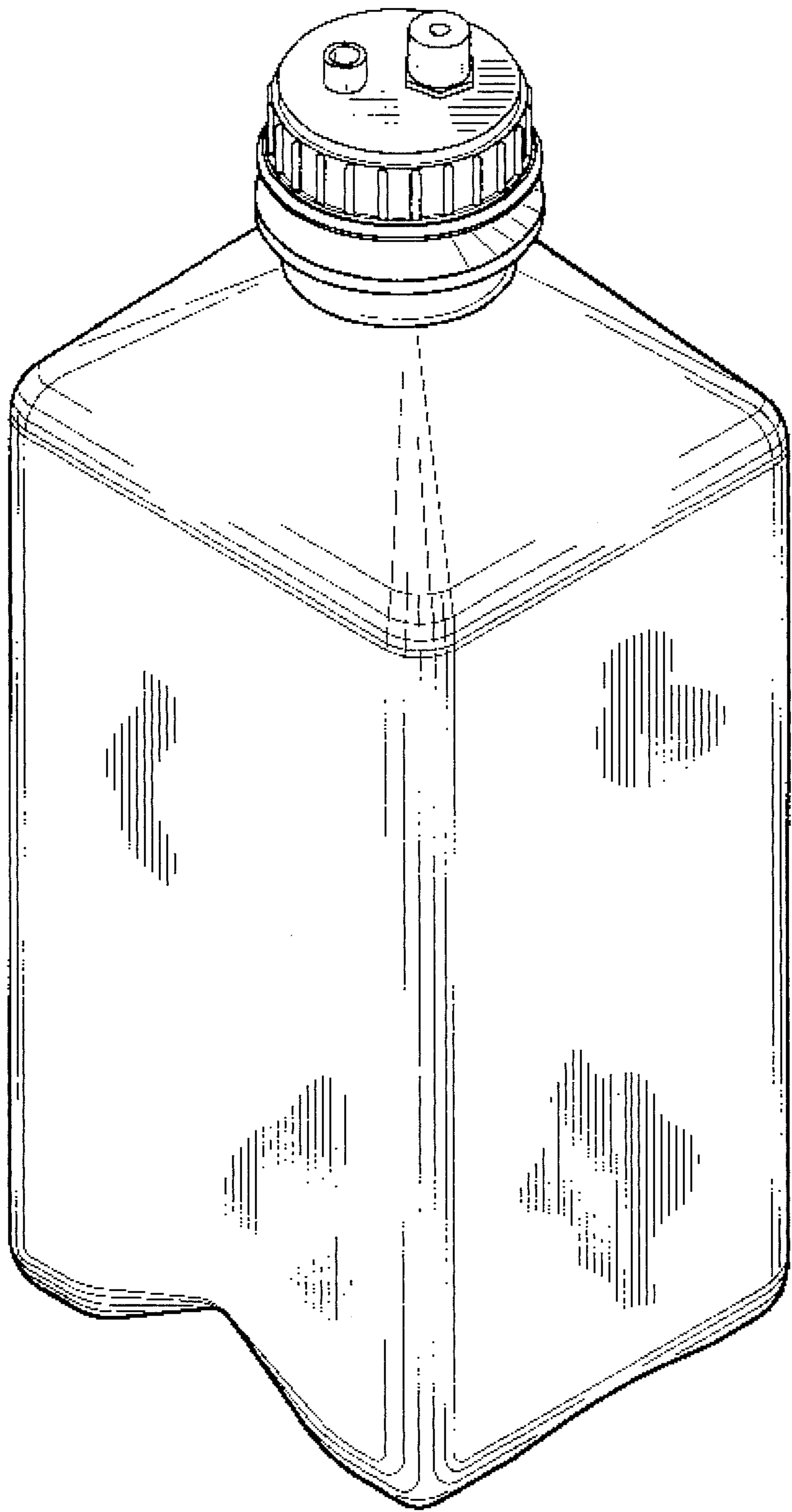

FIG-1

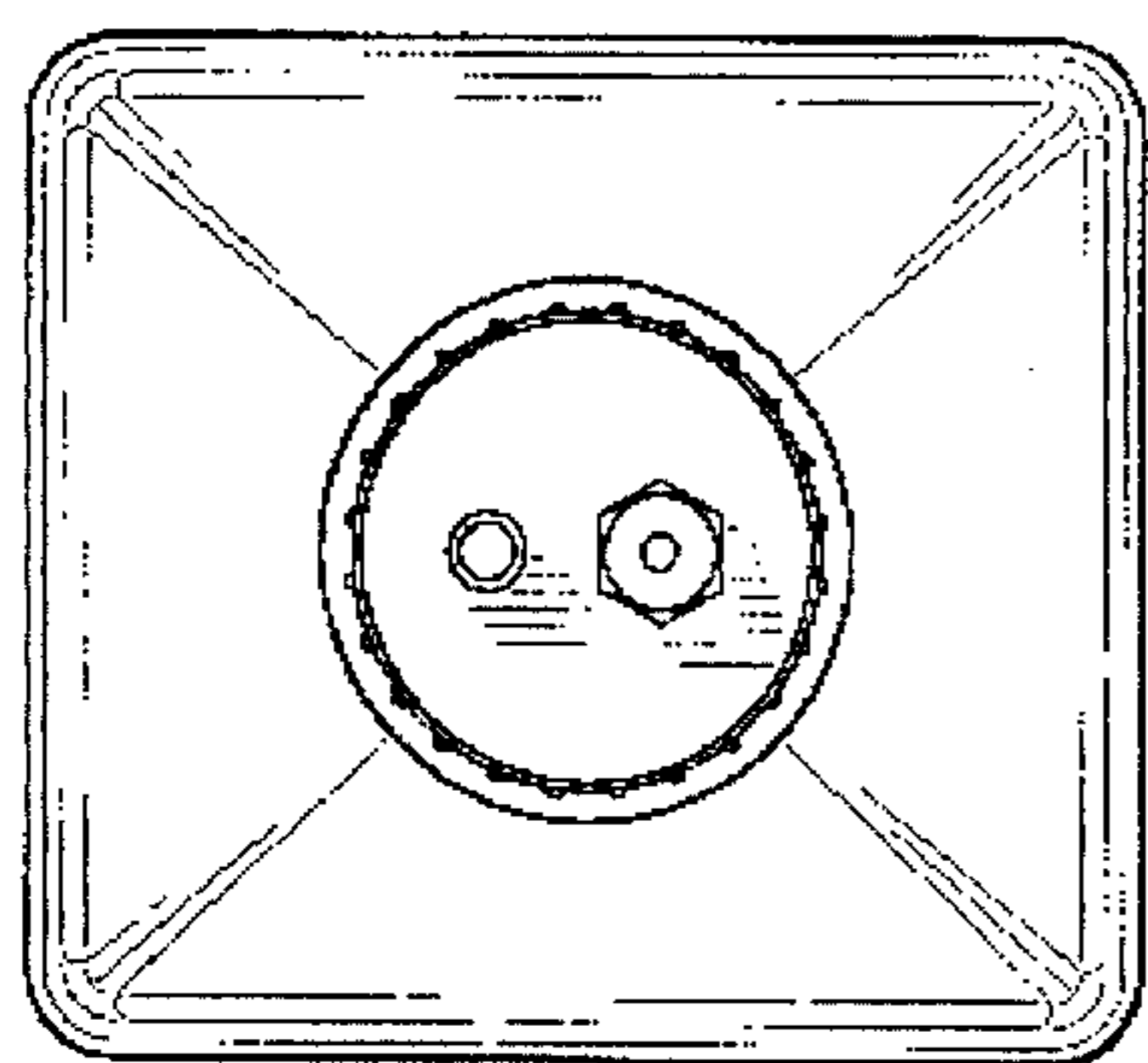

FIG-3

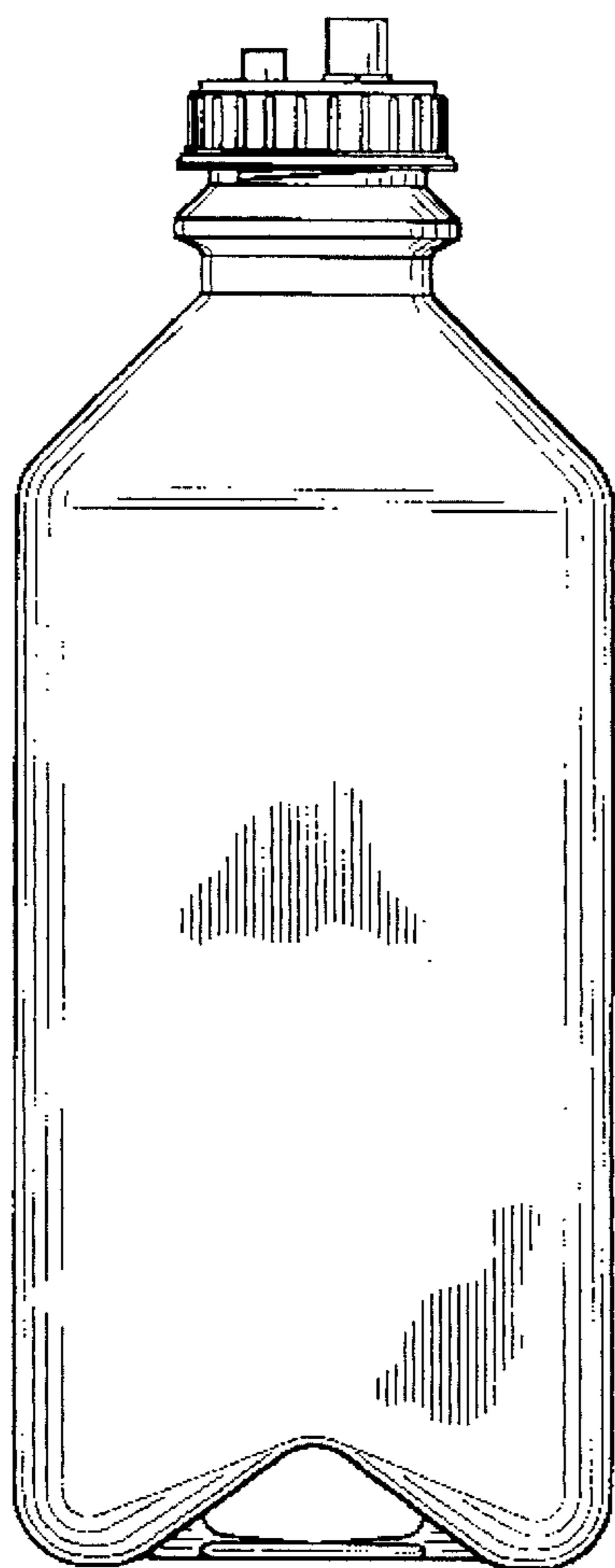

FIG-2

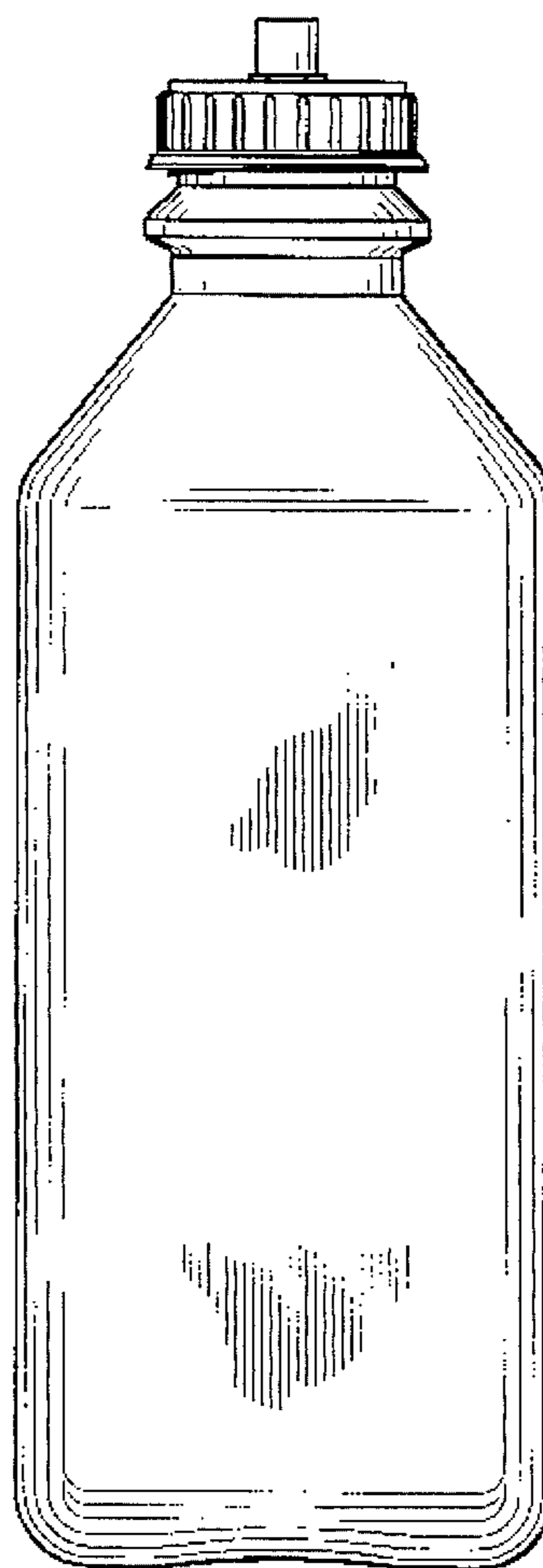

FIG-5

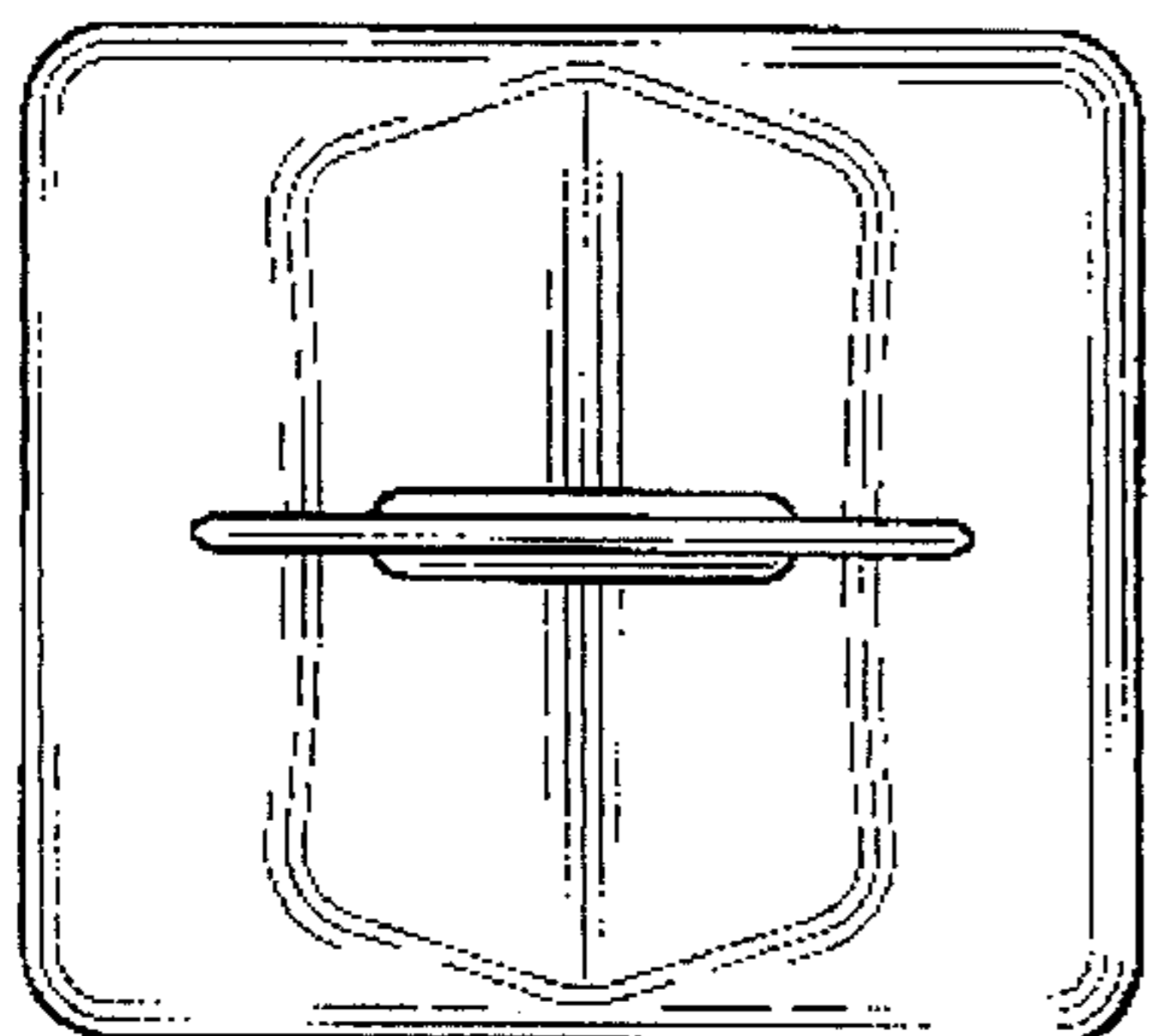

FIG-4

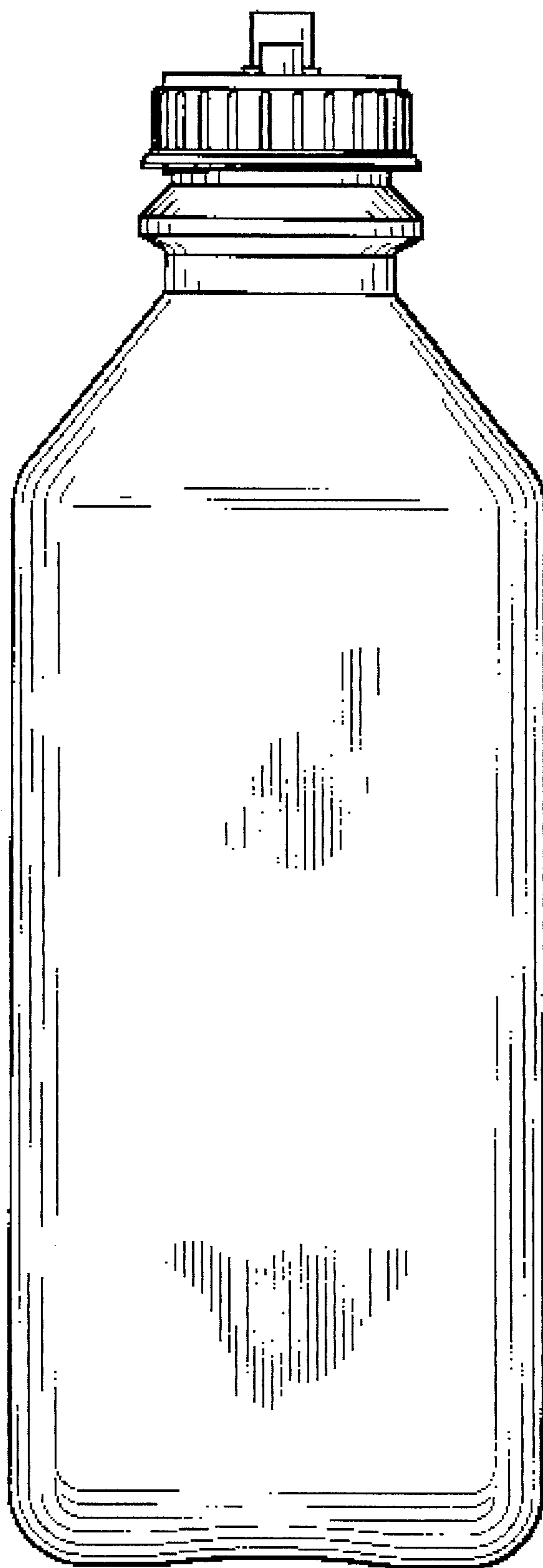

FIG-6

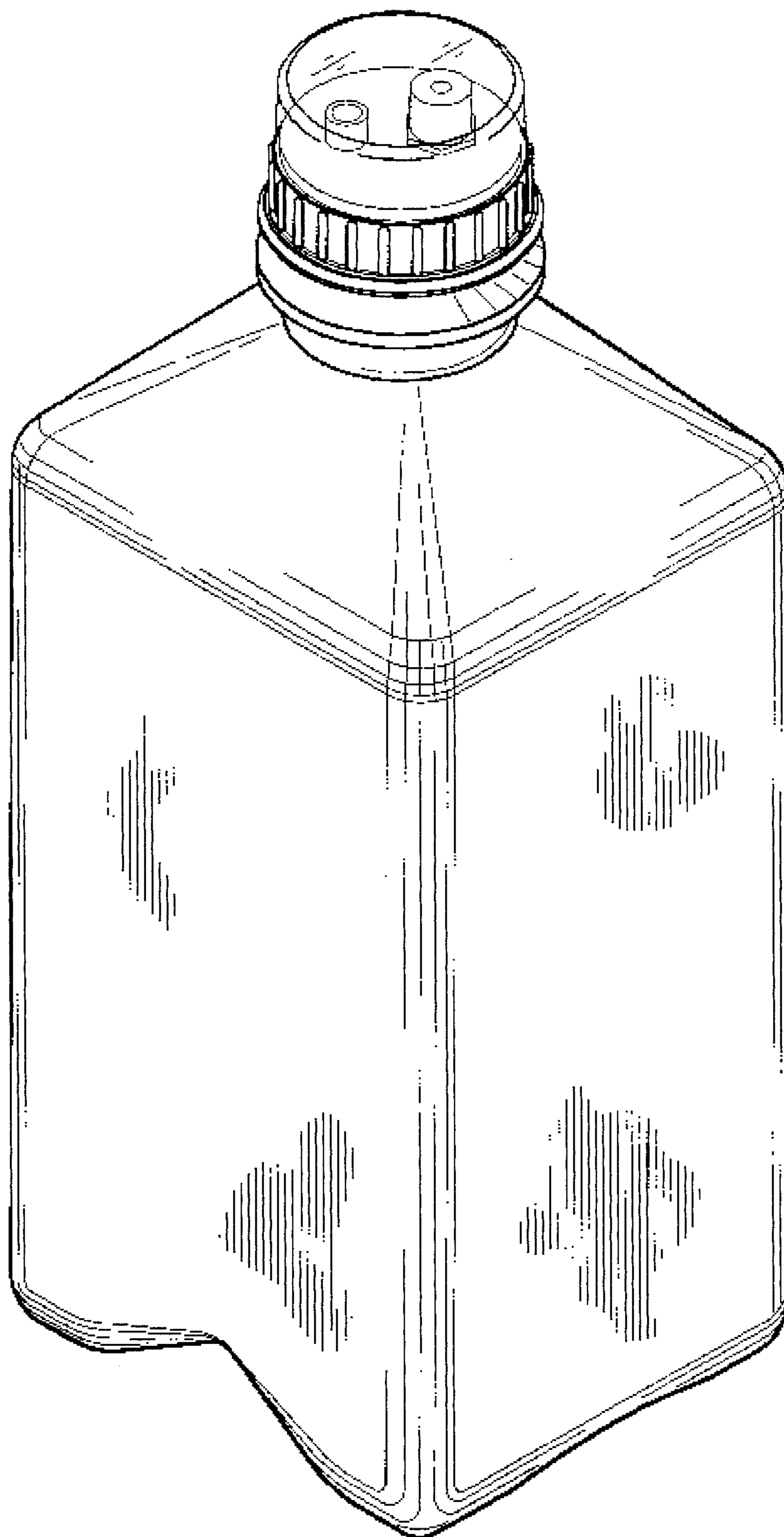

FIG-7

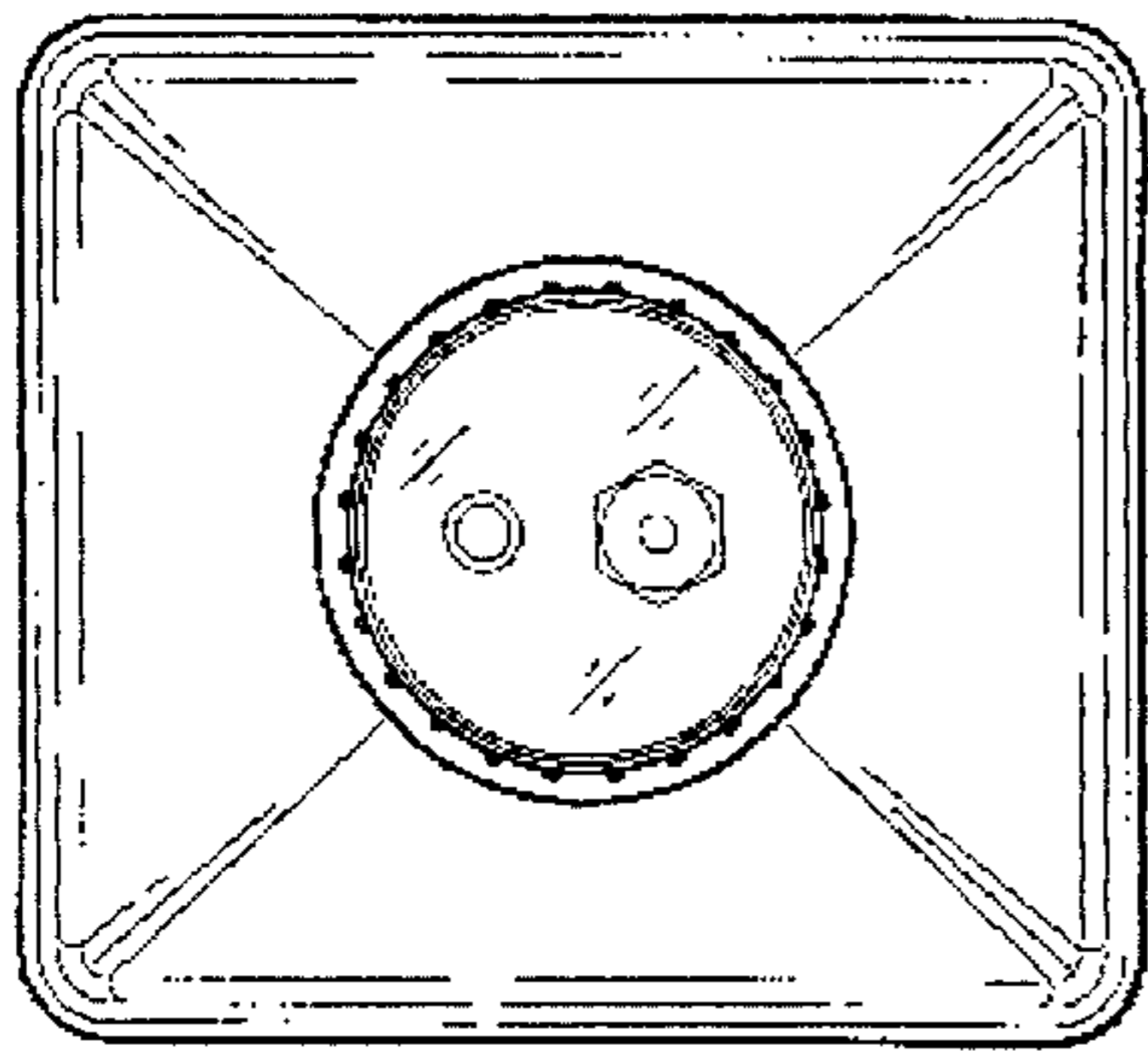

FIG-9

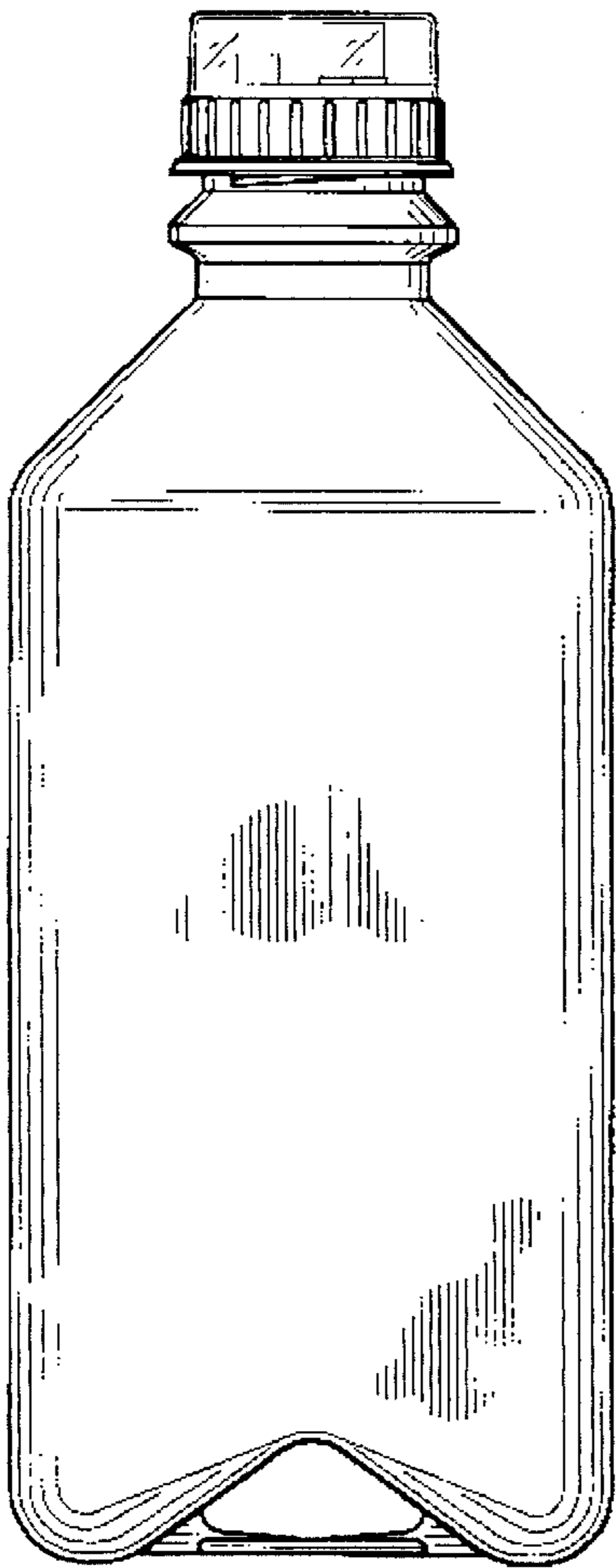

FIG-8

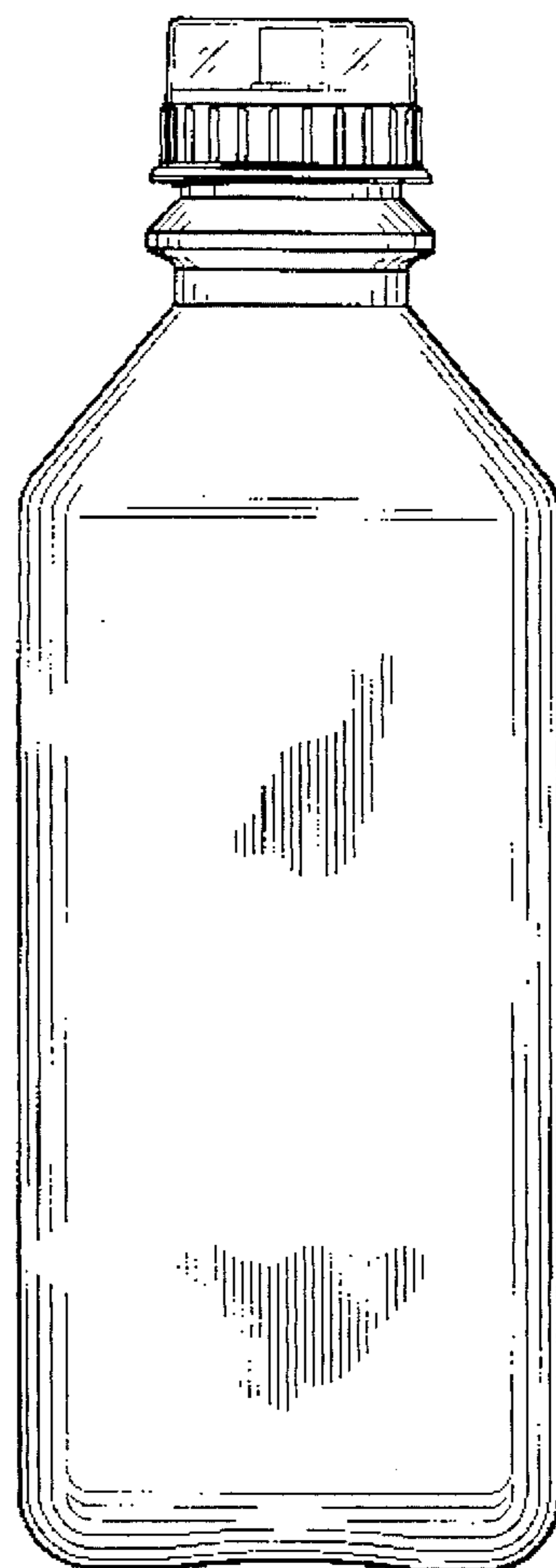

FIG-11

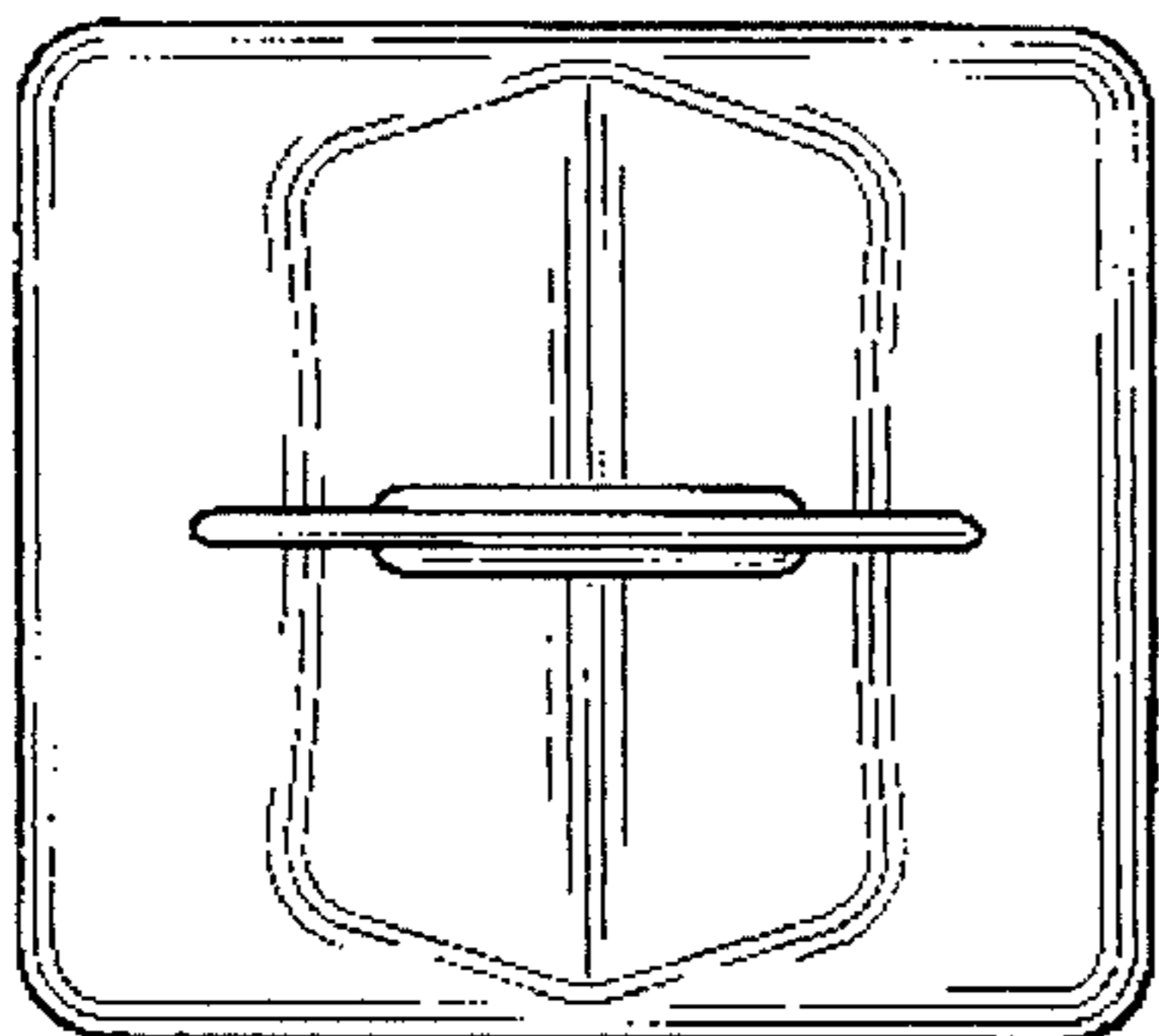

FIG-10

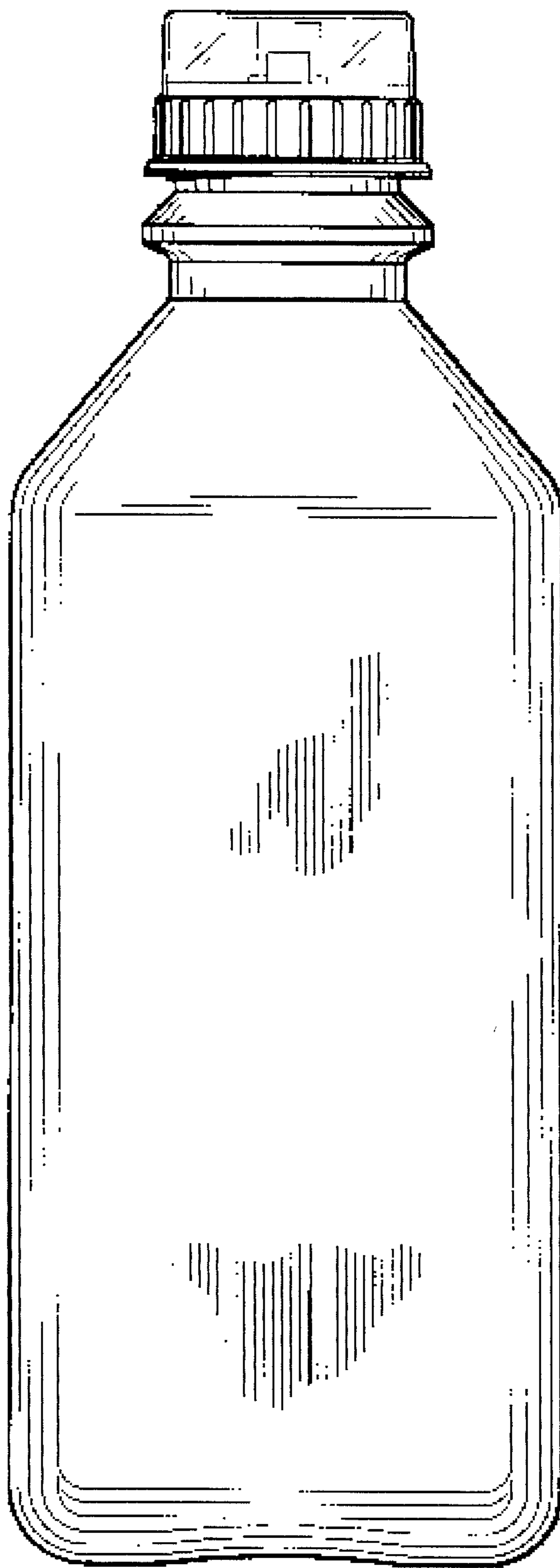

FIG-12

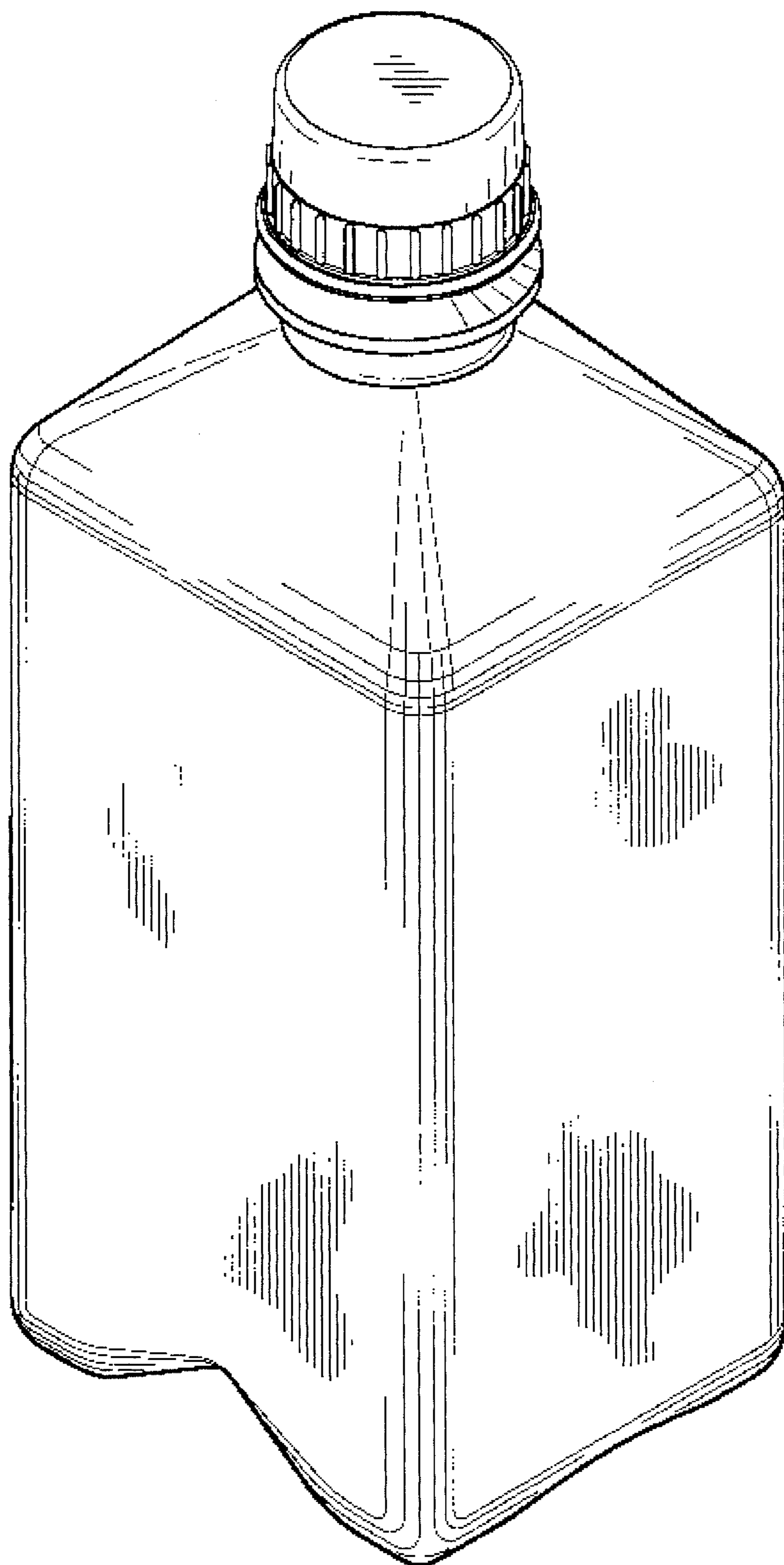

FIG-13

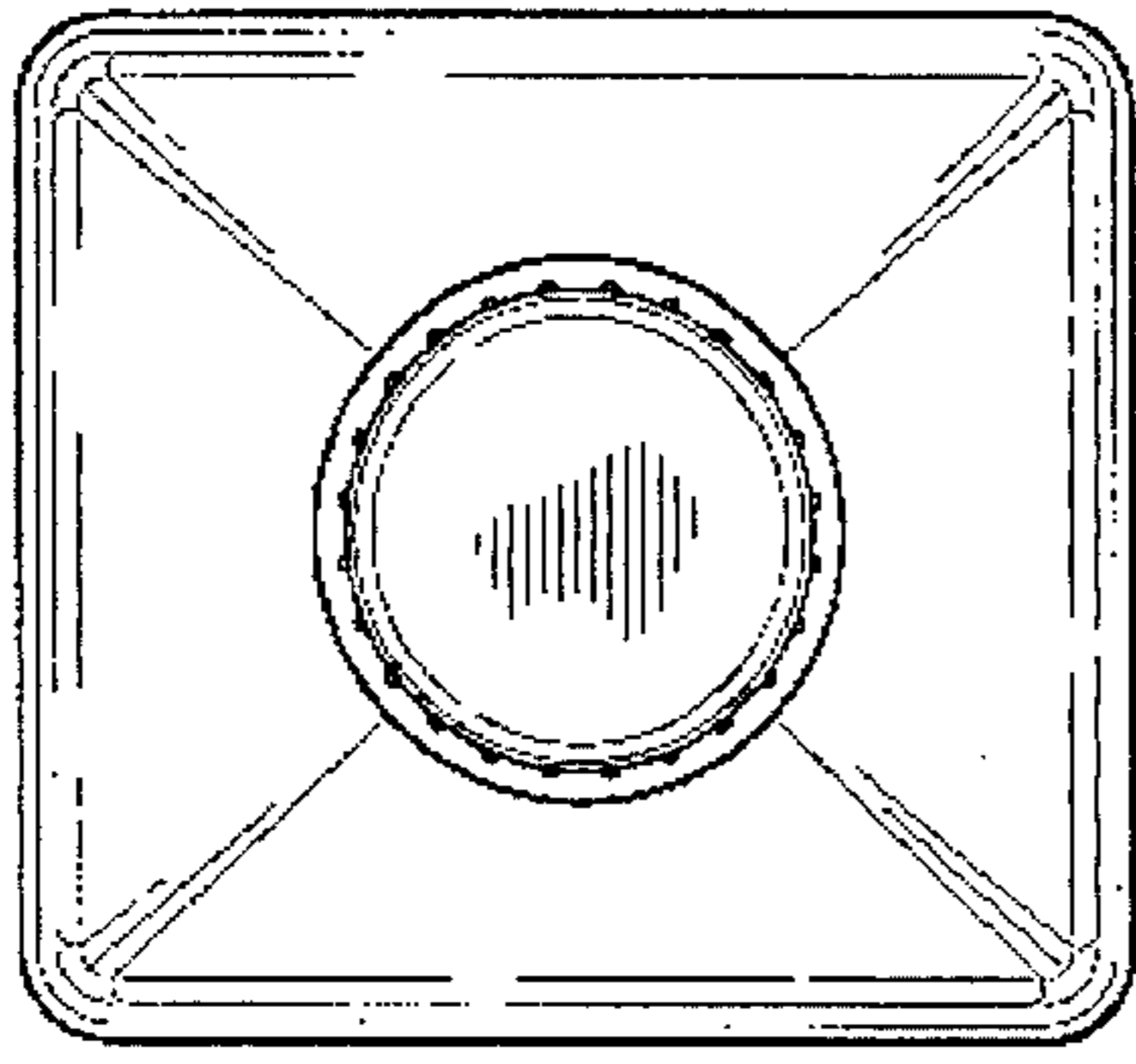

FIG-15

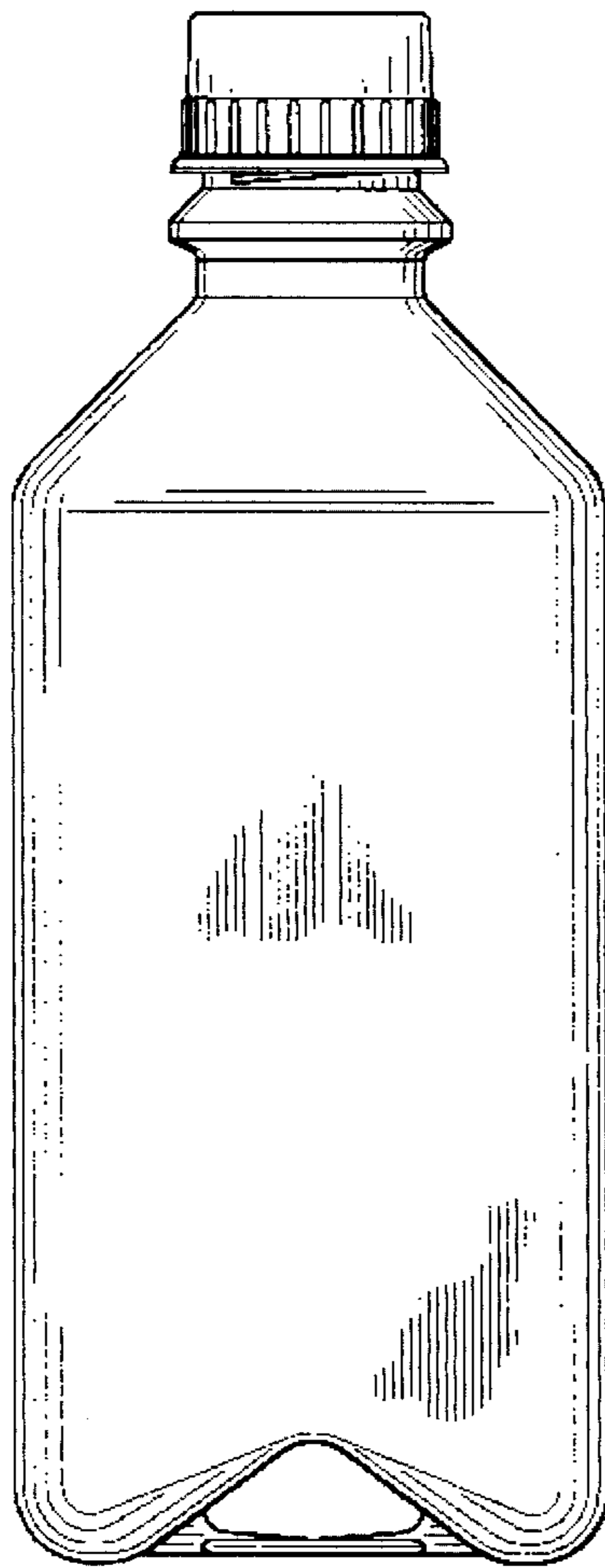

FIG-14

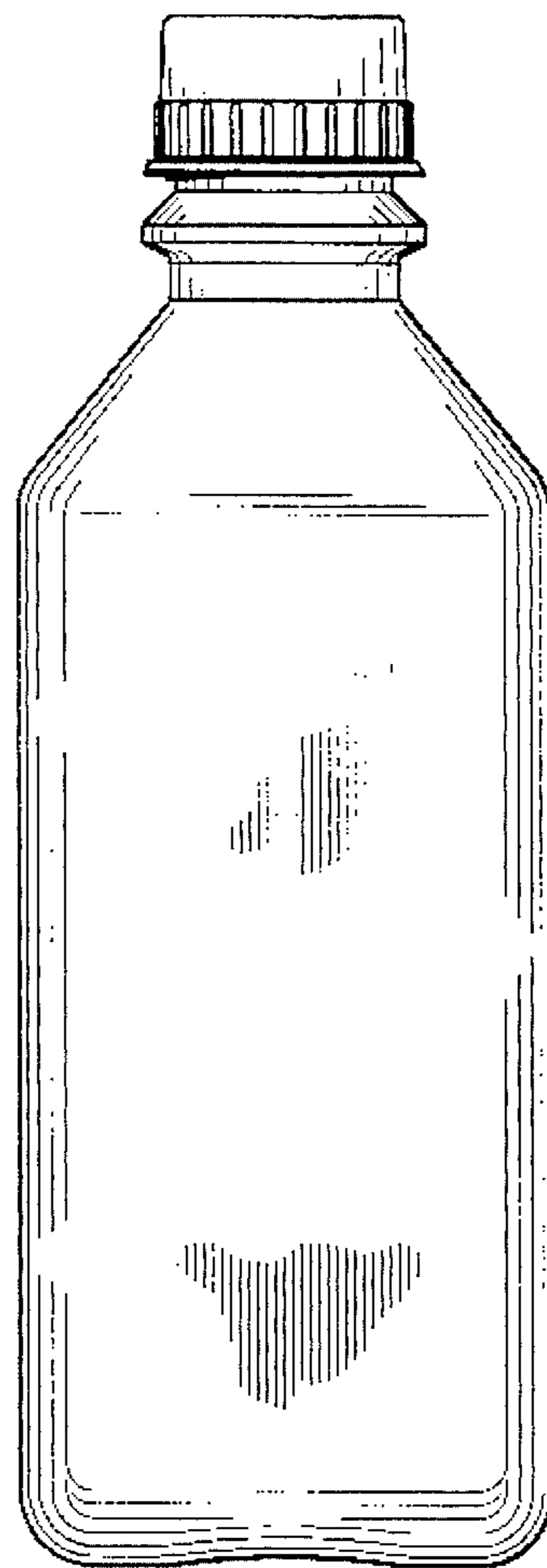

FIG-17

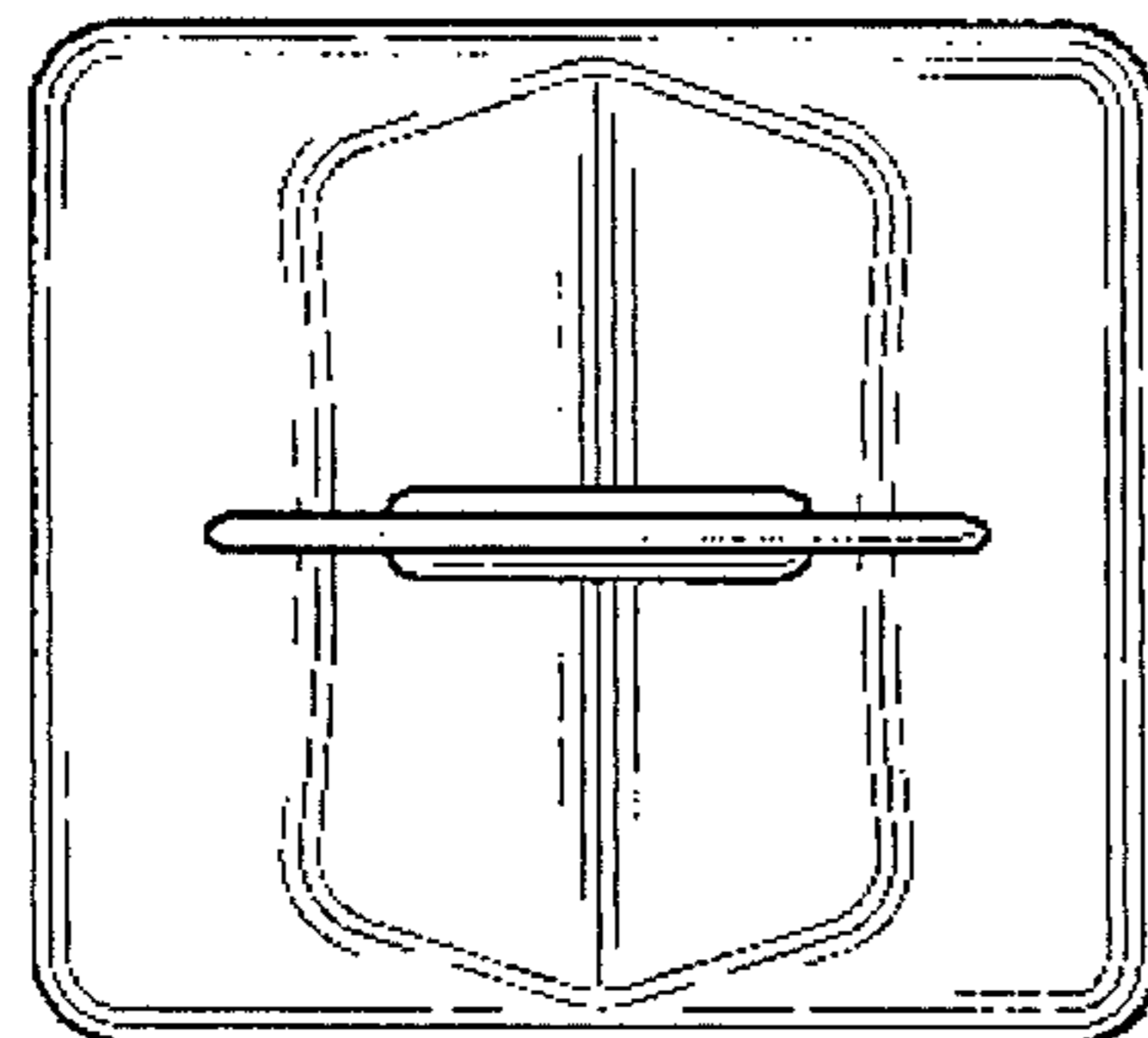

FIG-16

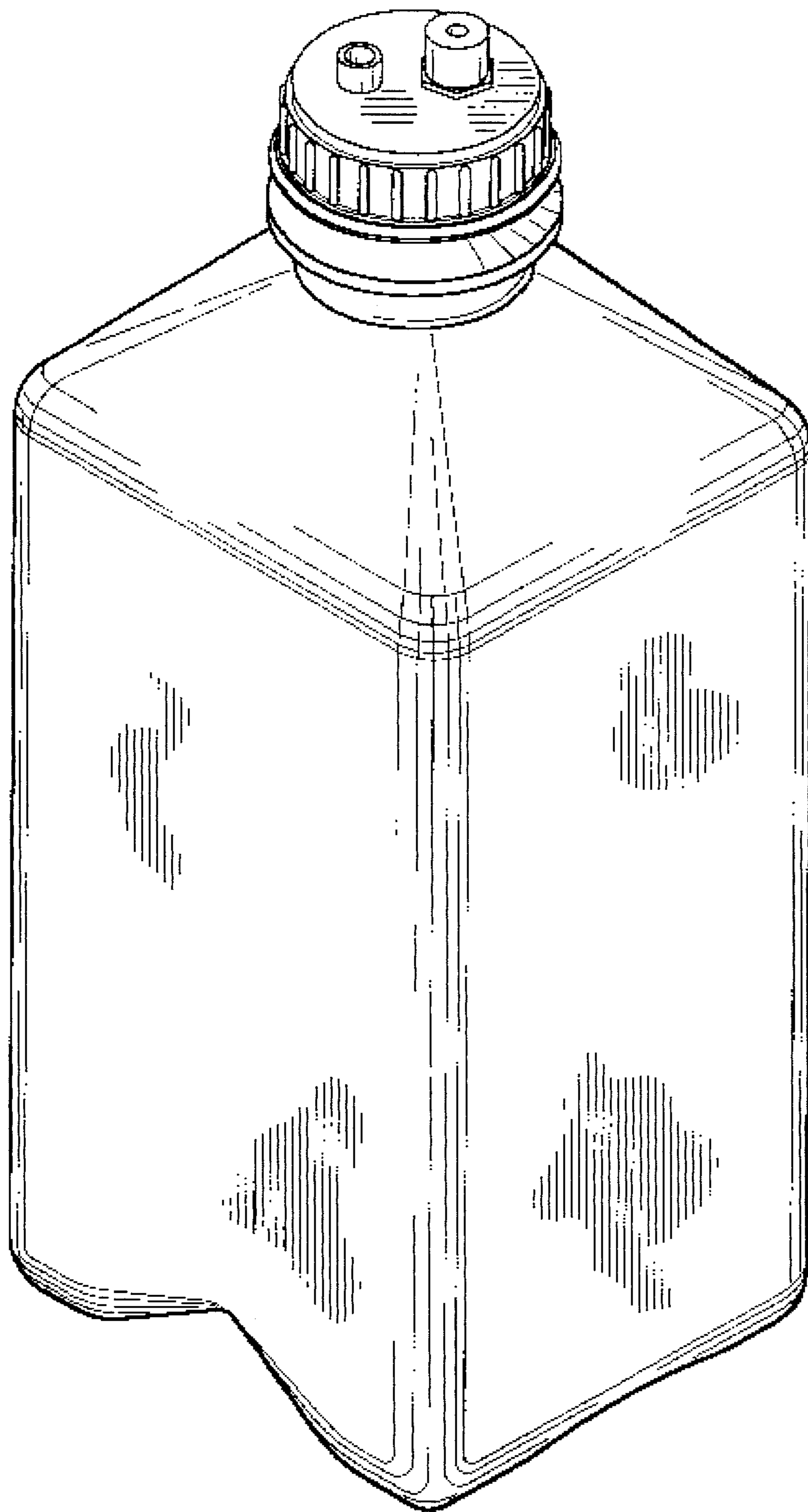

FIG-18

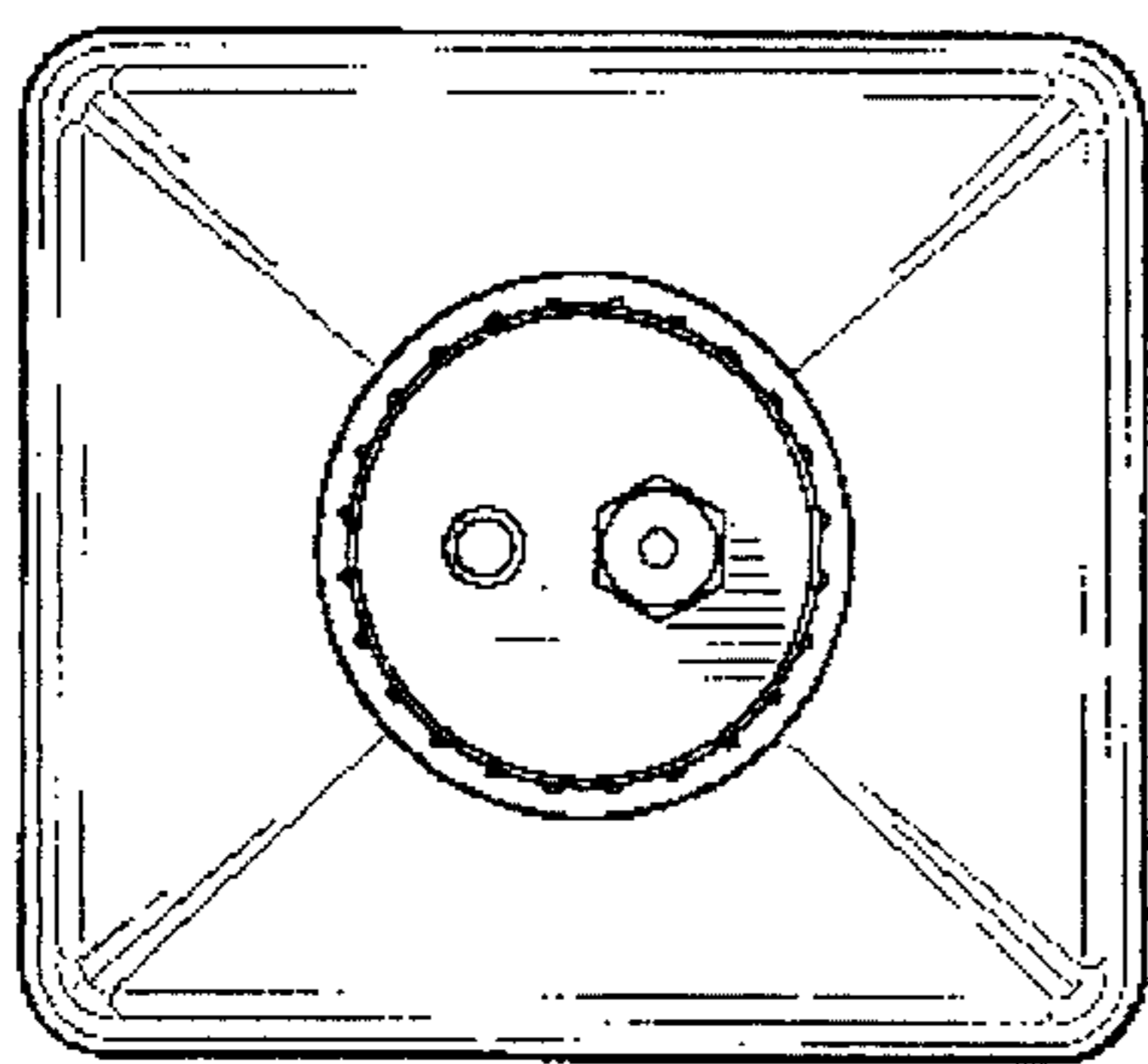

FIG-20

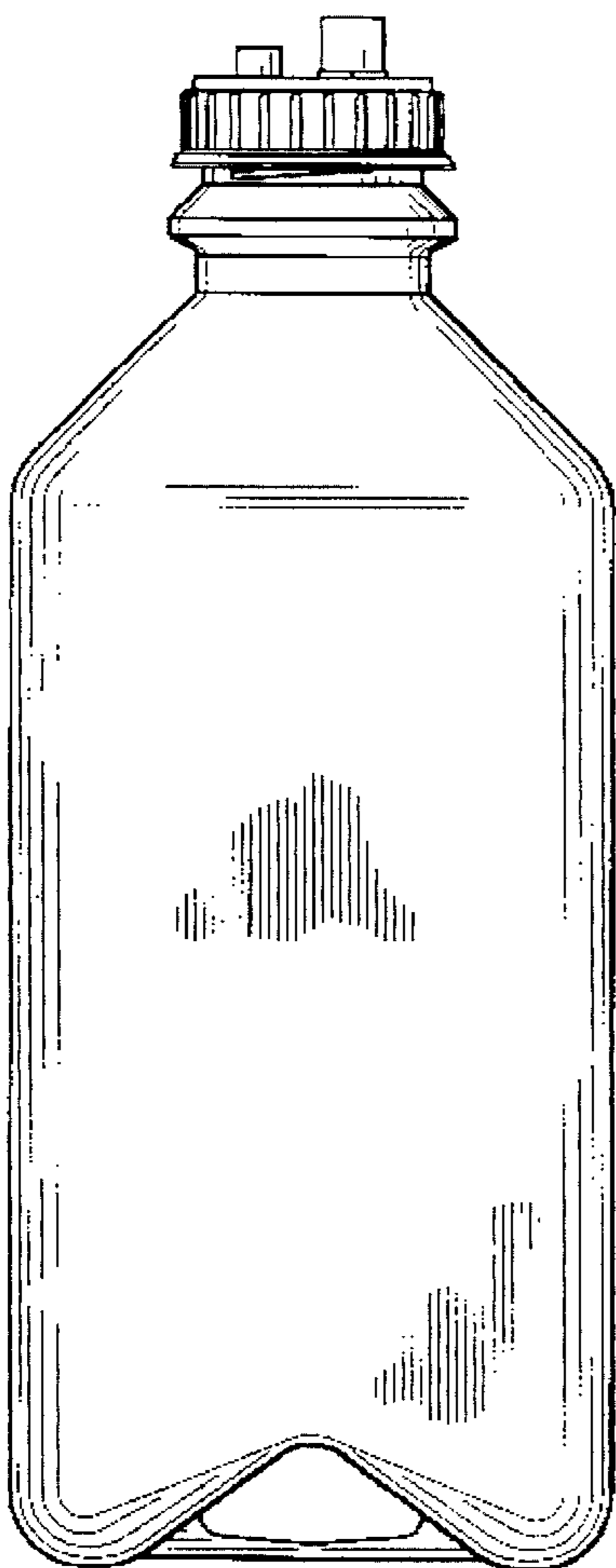

FIG-19

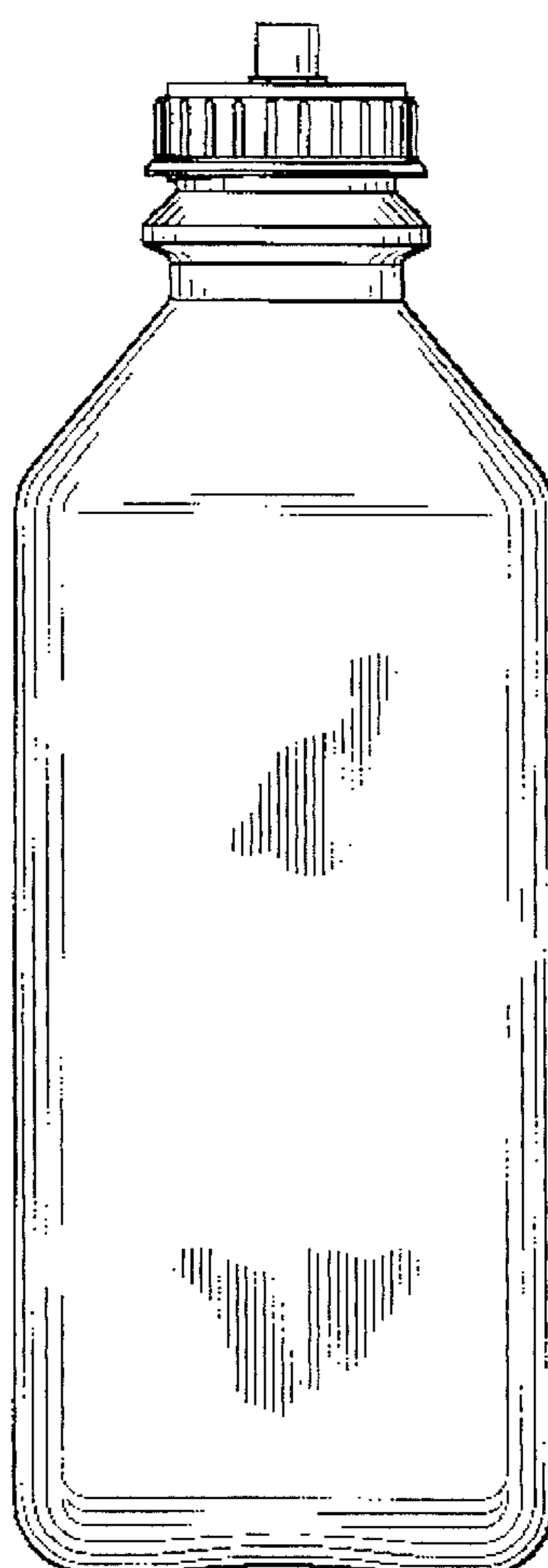

FIG-22

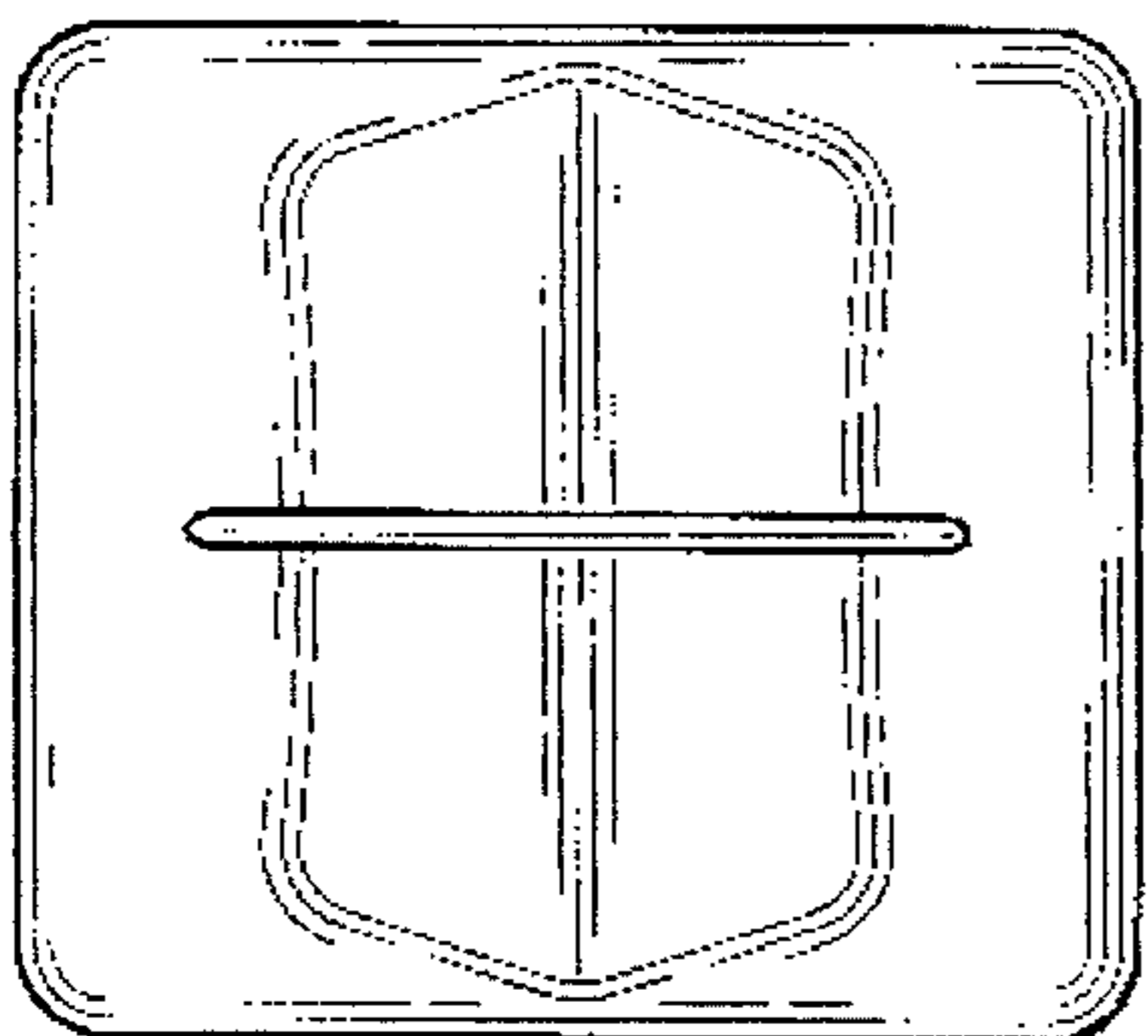

FIG-21

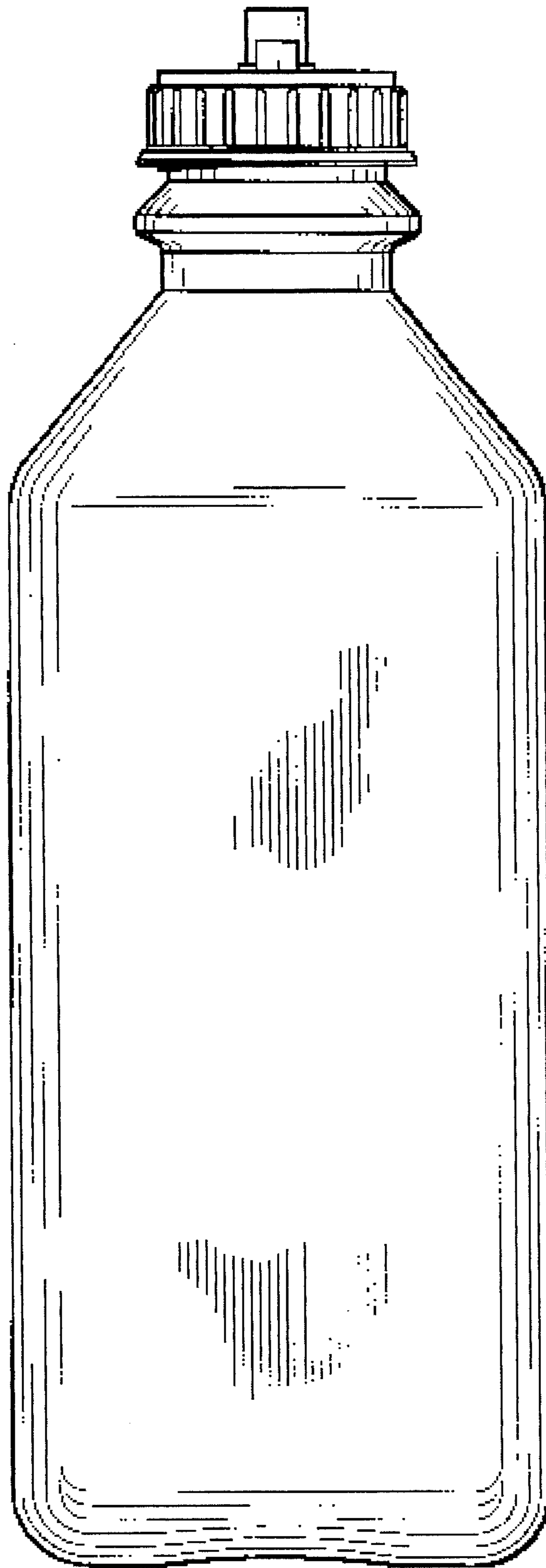

FIG-23

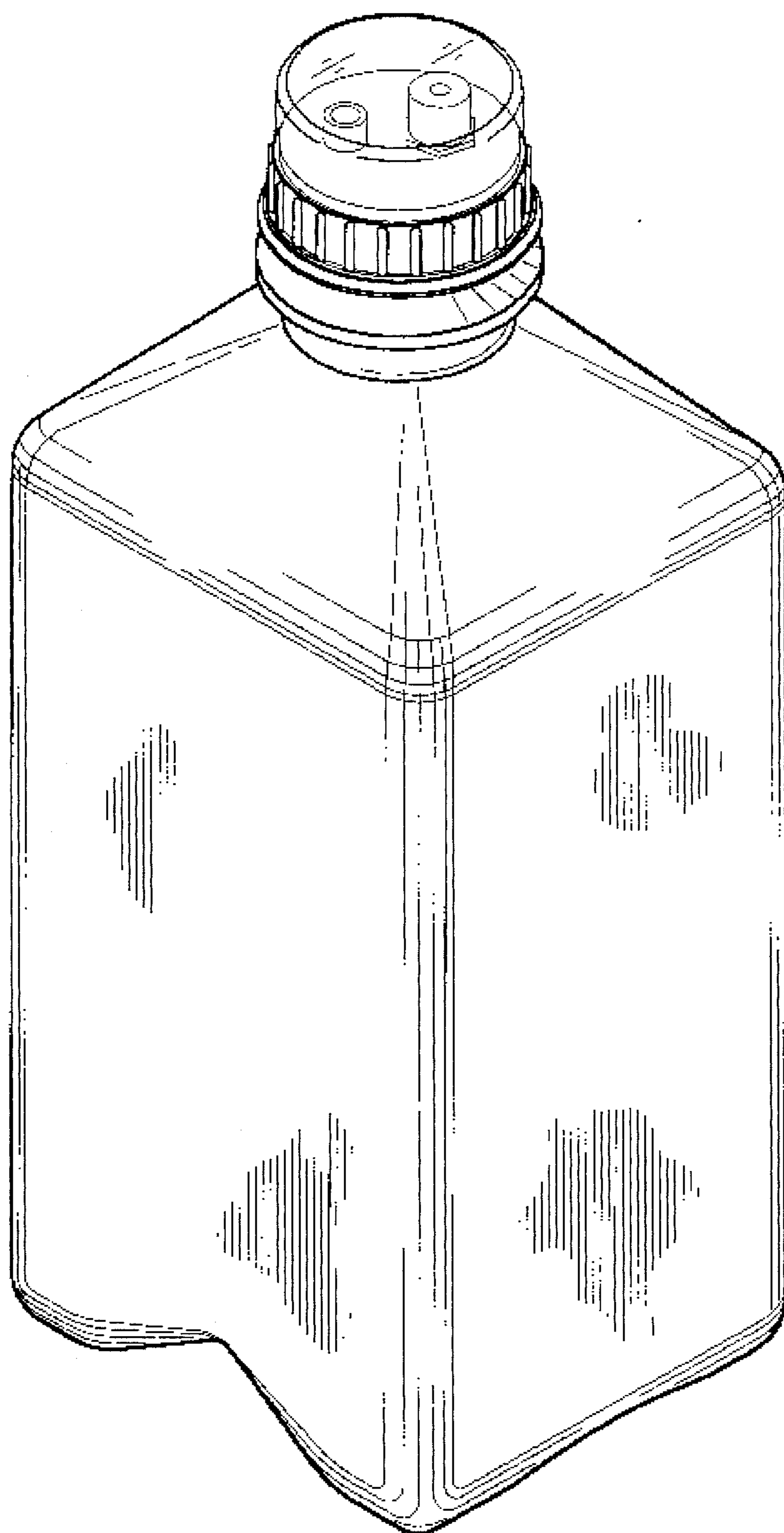

FIG-24

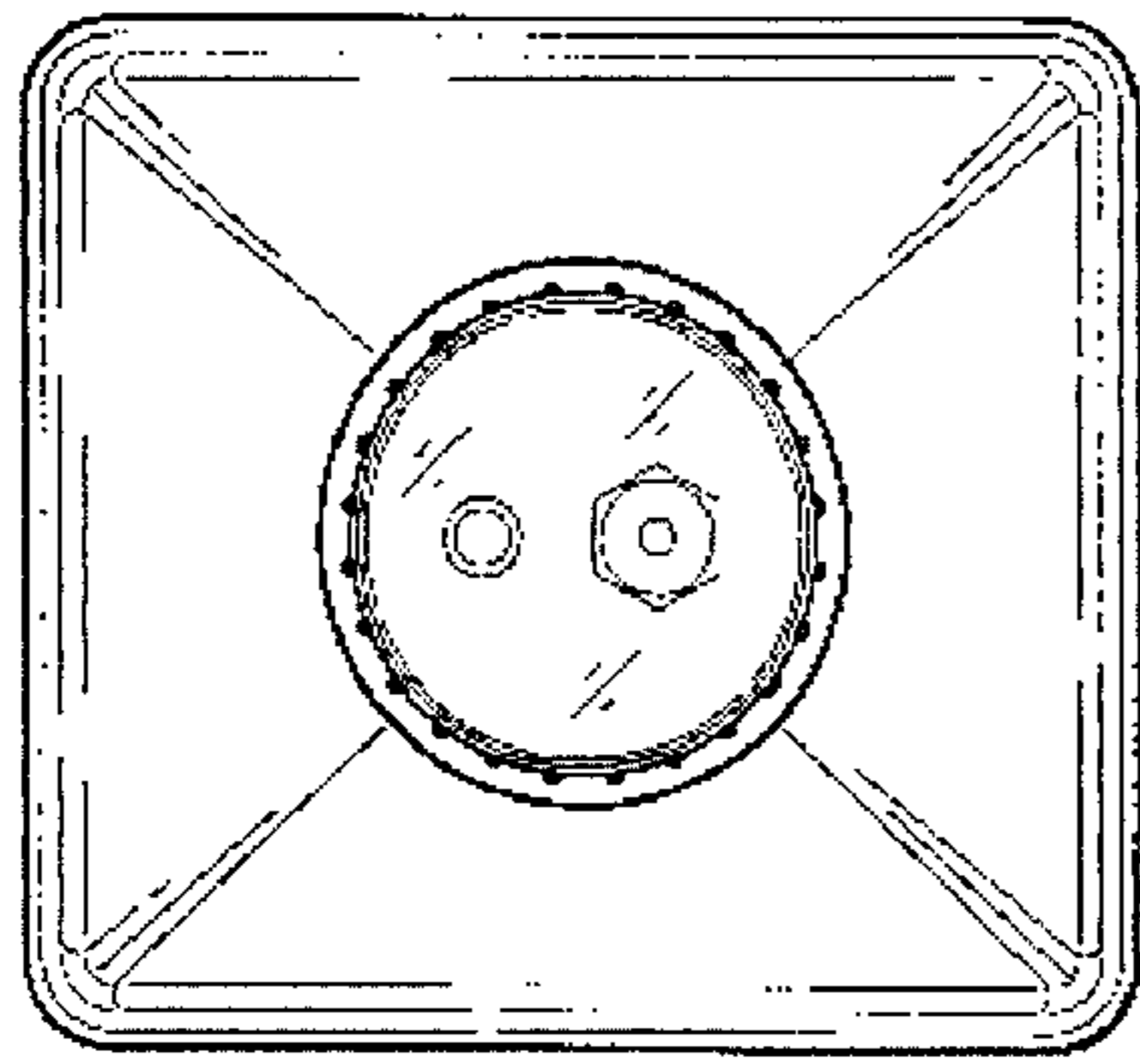

FIG-26

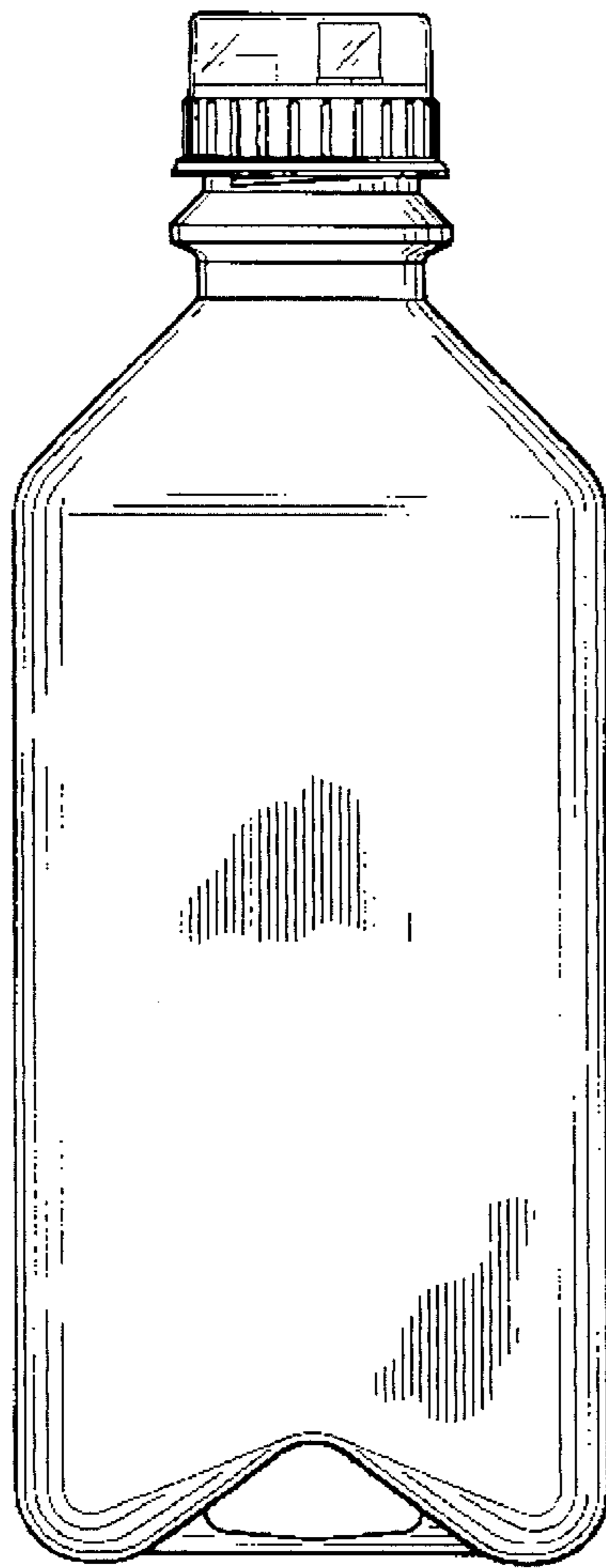

FIG-25

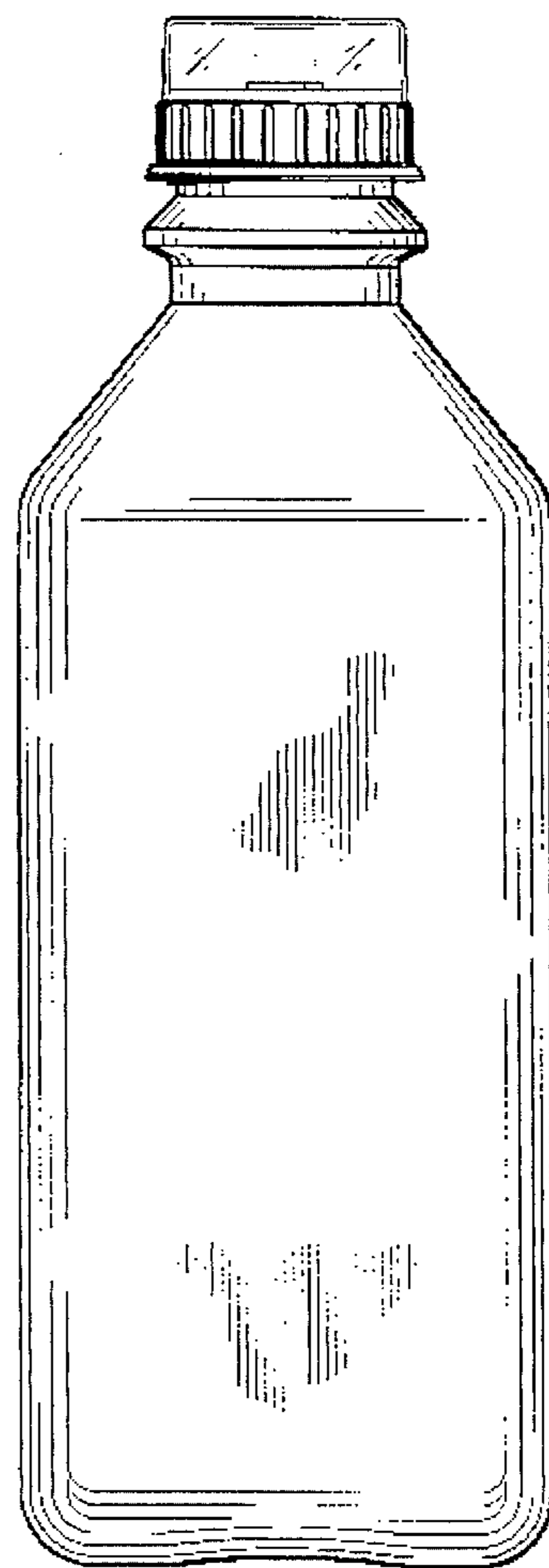

FIG-28

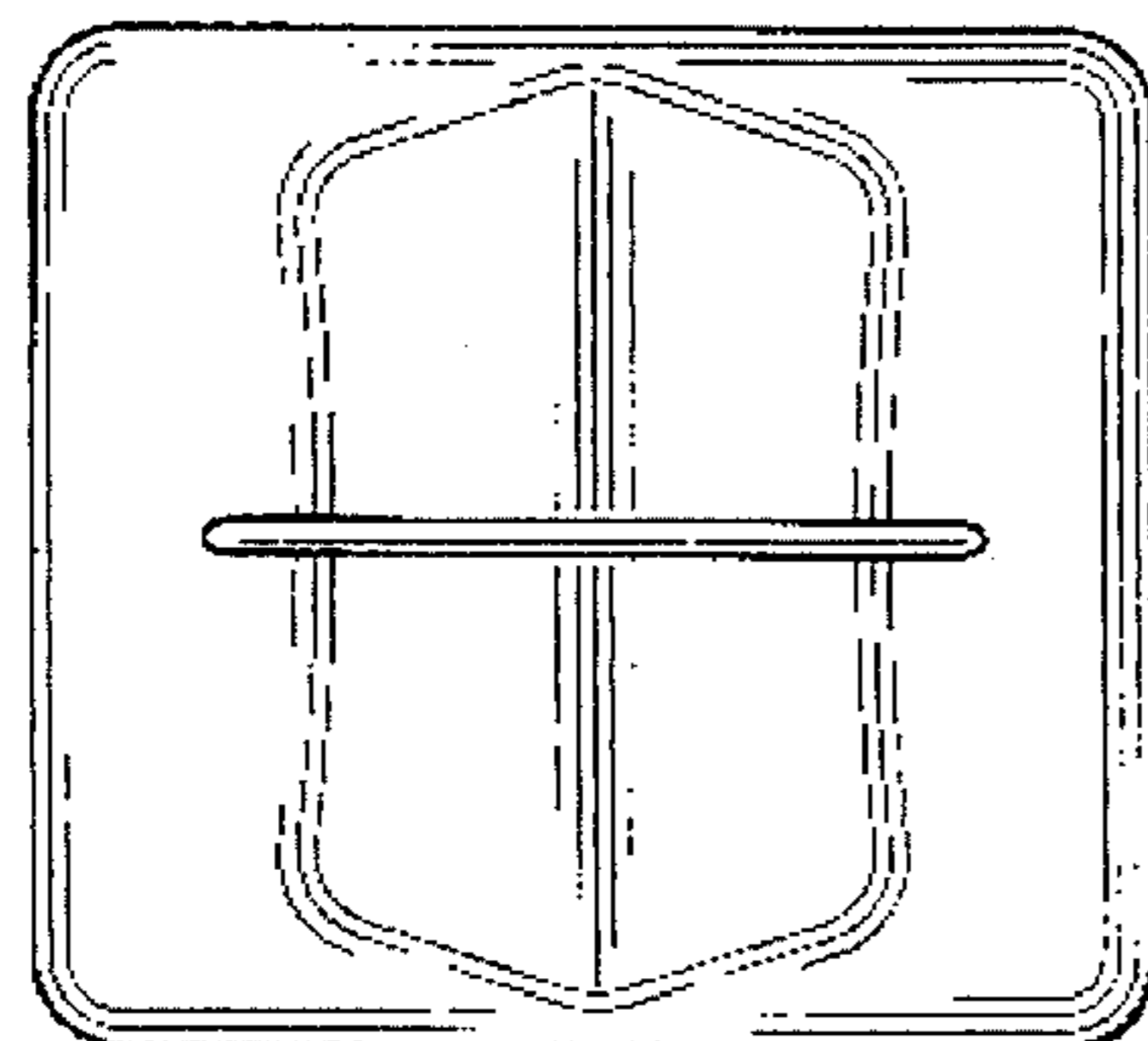

FIG-27

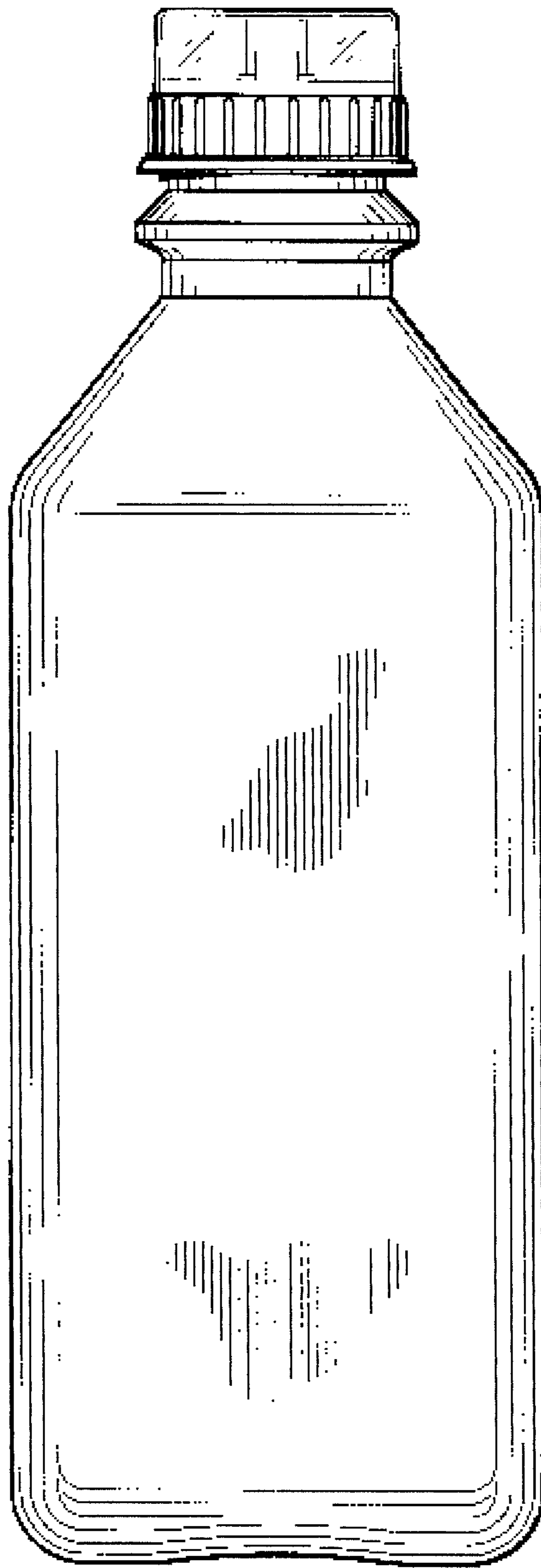

FIG-29

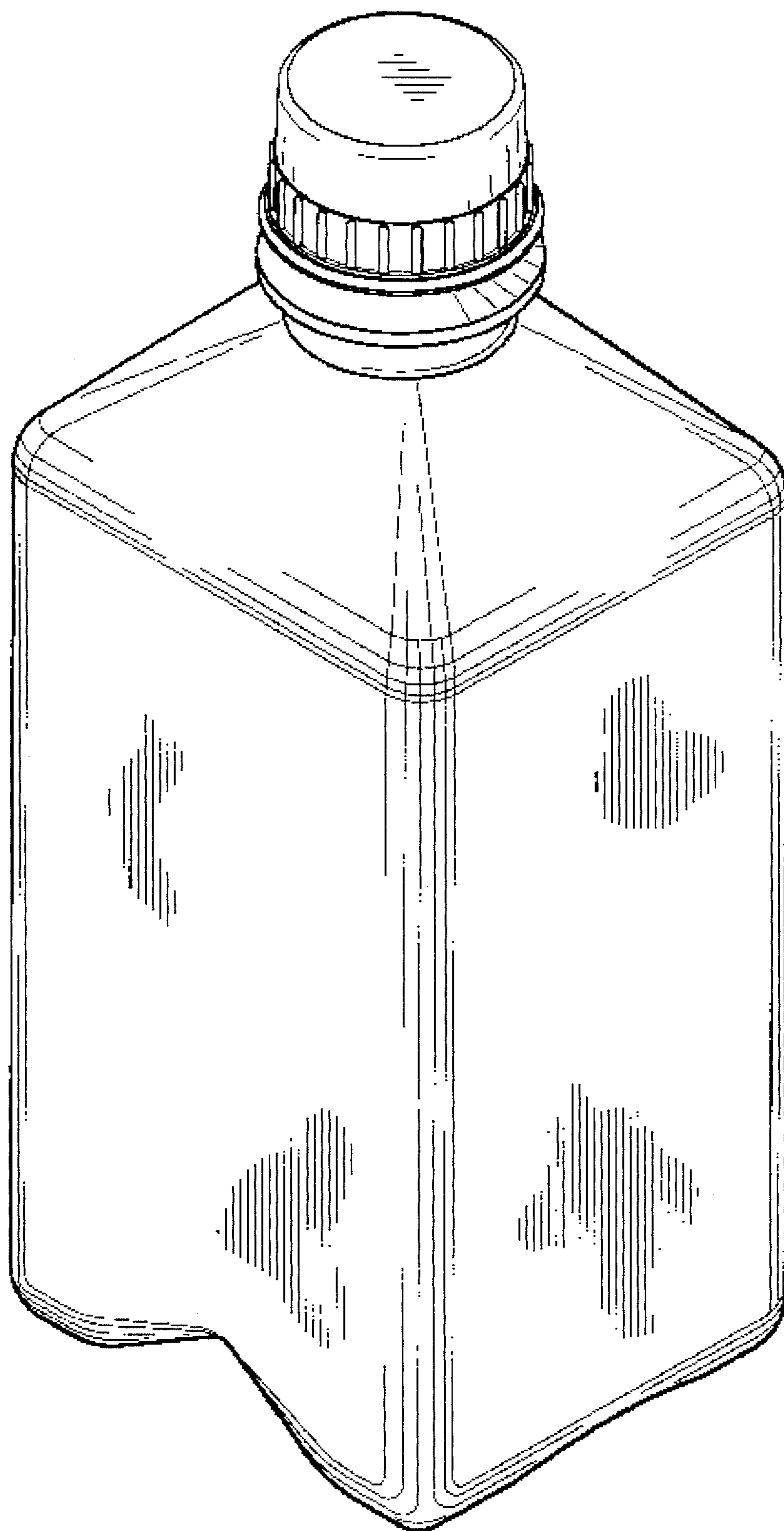

FIG-30

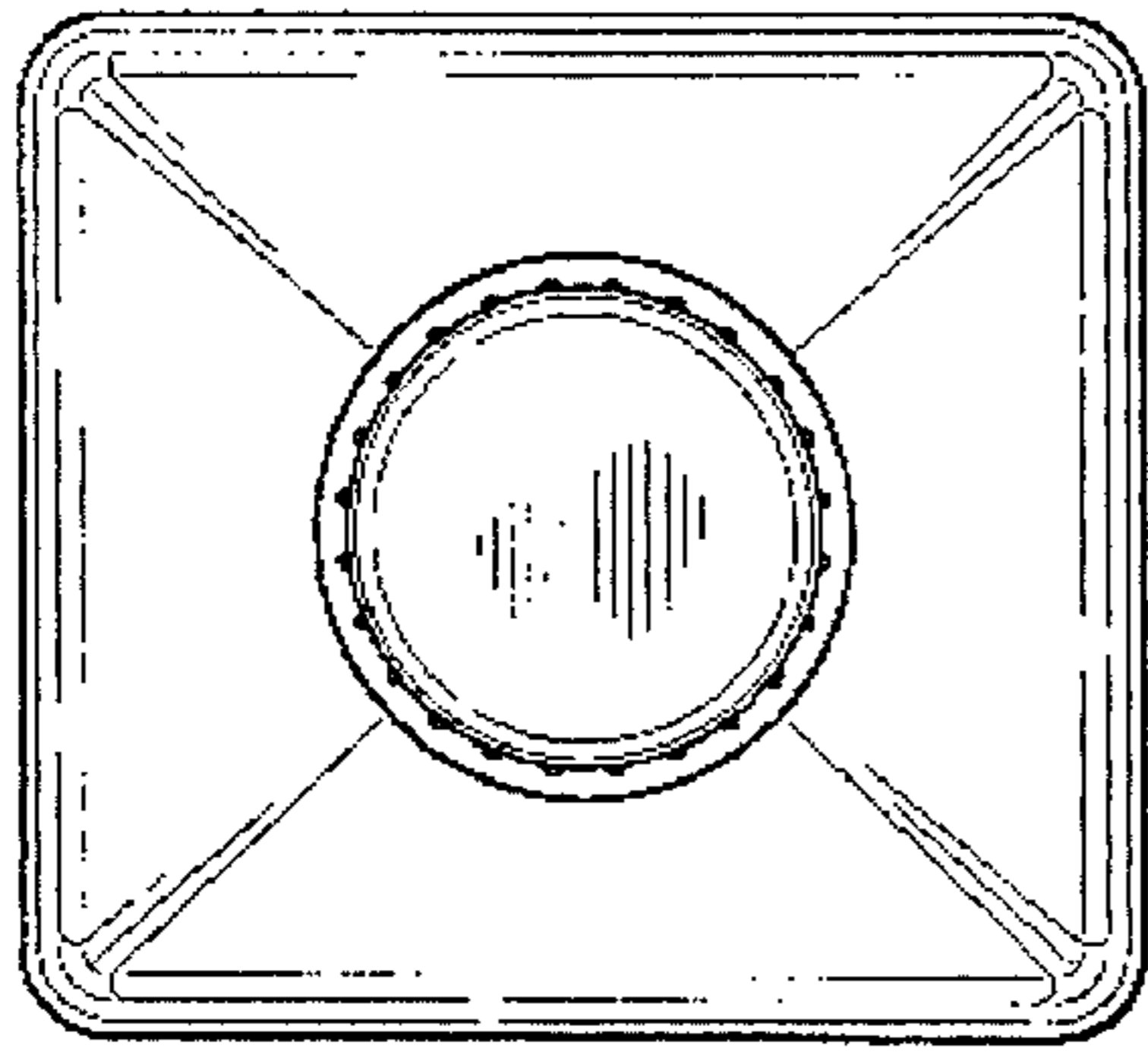

FIG-32

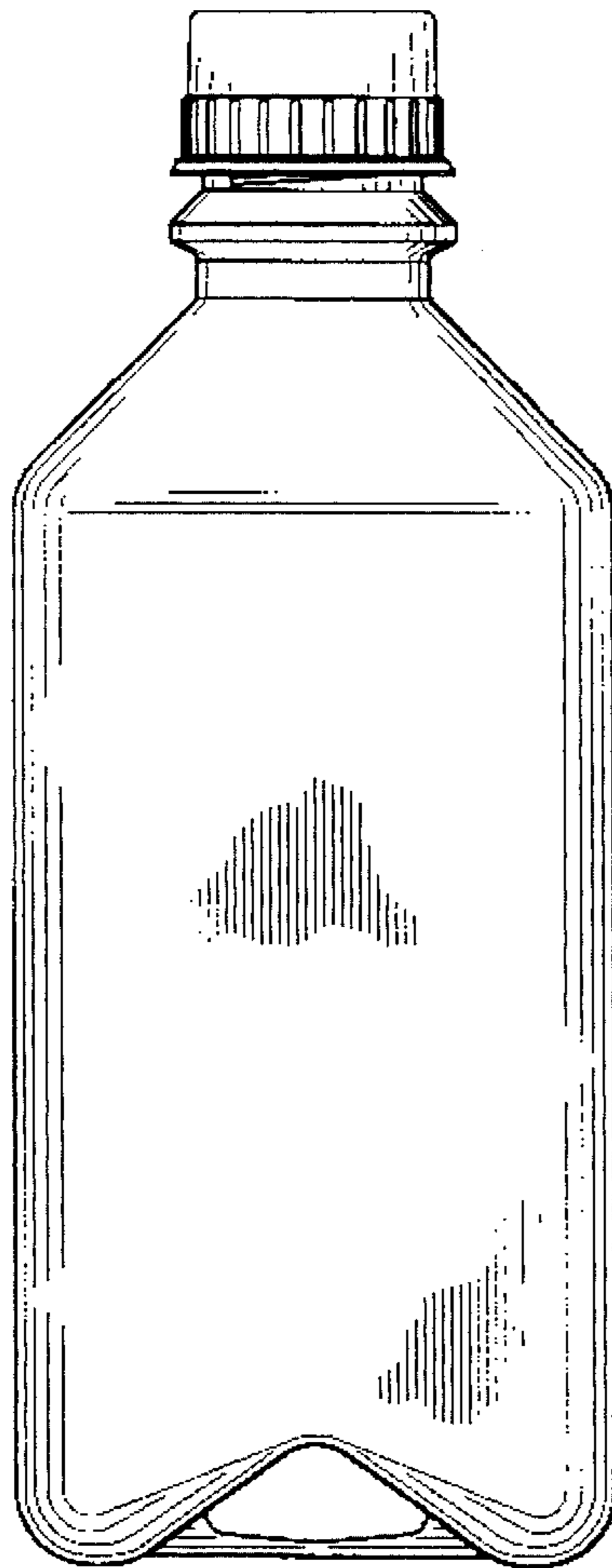

FIG-31

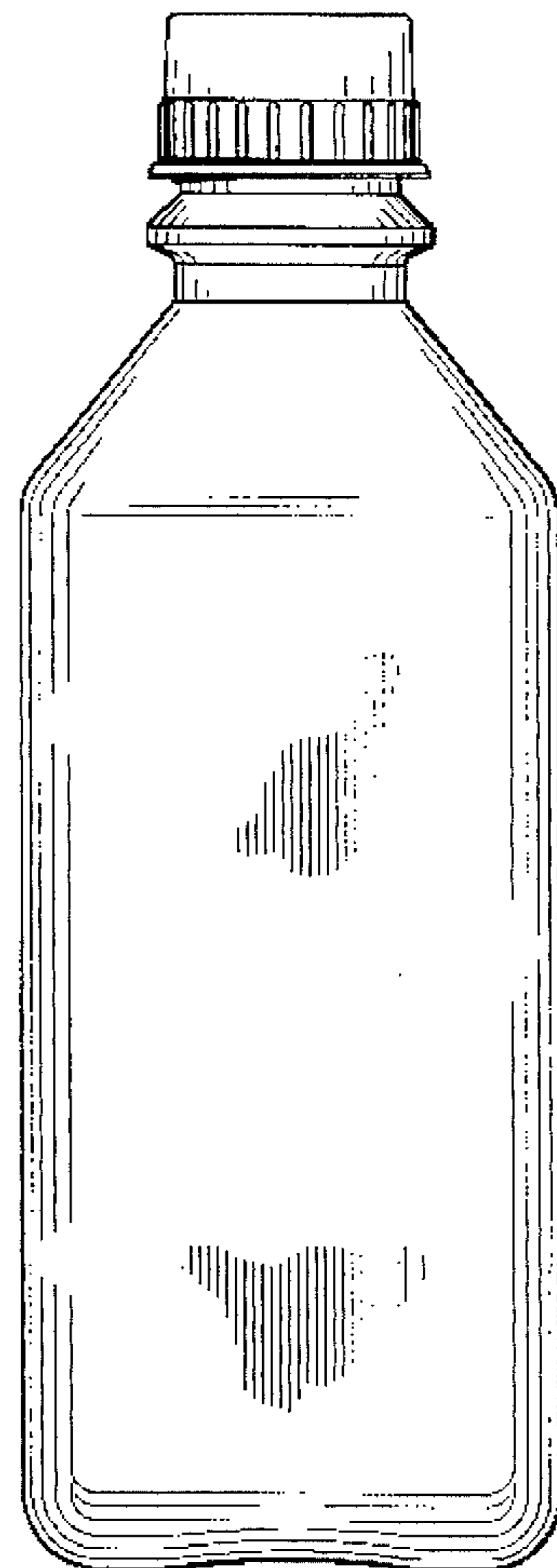

FIG-34

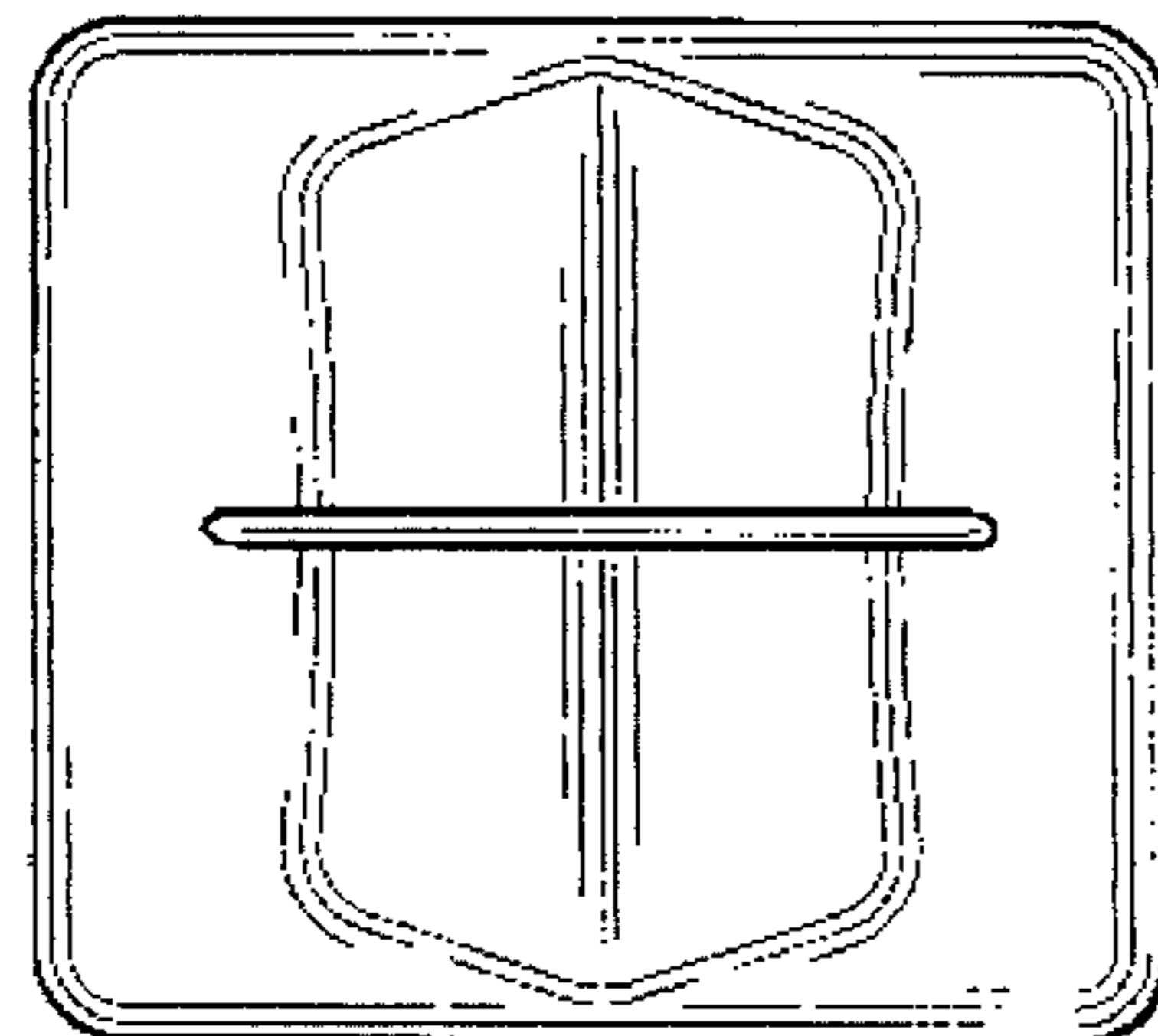

FIG-33