



US00D372520S

# United States Patent [19]

[11] Patent Number: **Des. 372,520**

Jacuzzi et al.

[45] Date of Patent: **\*\*Aug. 6, 1996**

## [54] COMBINED WHIRLPOOL BATHTUB AND SHOWER STALL

[75] Inventors: **Roy A. Jacuzzi**, Orinda; **Ralph D'Innocente**, Benecia, both of Calif.

[73] Assignee: **Jacuzzi Inc.**, Walnut Creek, Calif.

[\*\*] Term: **14 Years**

[21] Appl. No.: **42,801**

[22] Filed: **Aug. 17, 1995**

### Related U.S. Application Data

[62] Division of Ser. No. 26,700, Aug. 4, 1994.

[52] U.S. Cl. .... **D23/275**

[58] Field of Search ..... **D23/255, 277, 283, 279, 280.1, 280.2, 280.4, 283; 4/596, 600, 604, 605, 602, 607, 610, 612**

### [56] References Cited

#### U.S. PATENT DOCUMENTS

D. 319,093	8/1991	Dannenberg	.....	D23/275
D. 332,995	2/1993	Dworetzky	.....	D23/275
D. 341,192	11/1993	Dworetzky	.....	D23/275
D. 346,015	4/1994	Maskell et al.	.....	D23/275
4,928,329	5/1990	Palmeri	.....	4/604 X
5,070,549	12/1991	Campe	.....	4/596

Primary Examiner—Stella Reid

Assistant Examiner—Eric Watterson

Attorney, Agent, or Firm—Glen R. Grunewald

## [57] CLAIM

The ornamental design for a combined whirlpool bathtub and shower stall, as shown and described.

## DESCRIPTION

FIG. 1 is a right side perspective view of a combined whirlpool bathtub and shower stall, showing my new design; FIG. 2 is a left perspective view of a combined whirlpool bathtub and shower stall, with the shower portion removed; FIG. 3 is a top plan view thereof;

FIG. 4 is a right side elevational view thereof;

FIG. 5 is a cross-sectional view taken along line 5—5 of FIG. 3;

FIG. 6 is a cross-sectional view taken along line 6—6 of FIG. 3;

FIG. 7 is a right side perspective view of the shower portion;

FIG. 8 is a right side perspective view of the shower portion, with the door partly closed;

FIG. 9 is an end view taken in the direction of line 9—9 of FIG. 11;

FIG. 10 is a side elevational view taken in the direction of line 10—10 of FIG. 11;

FIG. 11 is a top plan view thereof;

FIG. 12 is a cross-sectional view taken along line 12—12 of FIG. 13;

FIG. 13 is a cross-sectional view taken along line 13—13 of FIG. 8; and,

FIG. 14 is a side elevational view taken in the direction of line 14—14 of FIG. 11.

The broken lines shown are for illustrative purposes only and form no part of the claimed design.

**1 Claim, 14 Drawing Sheets**

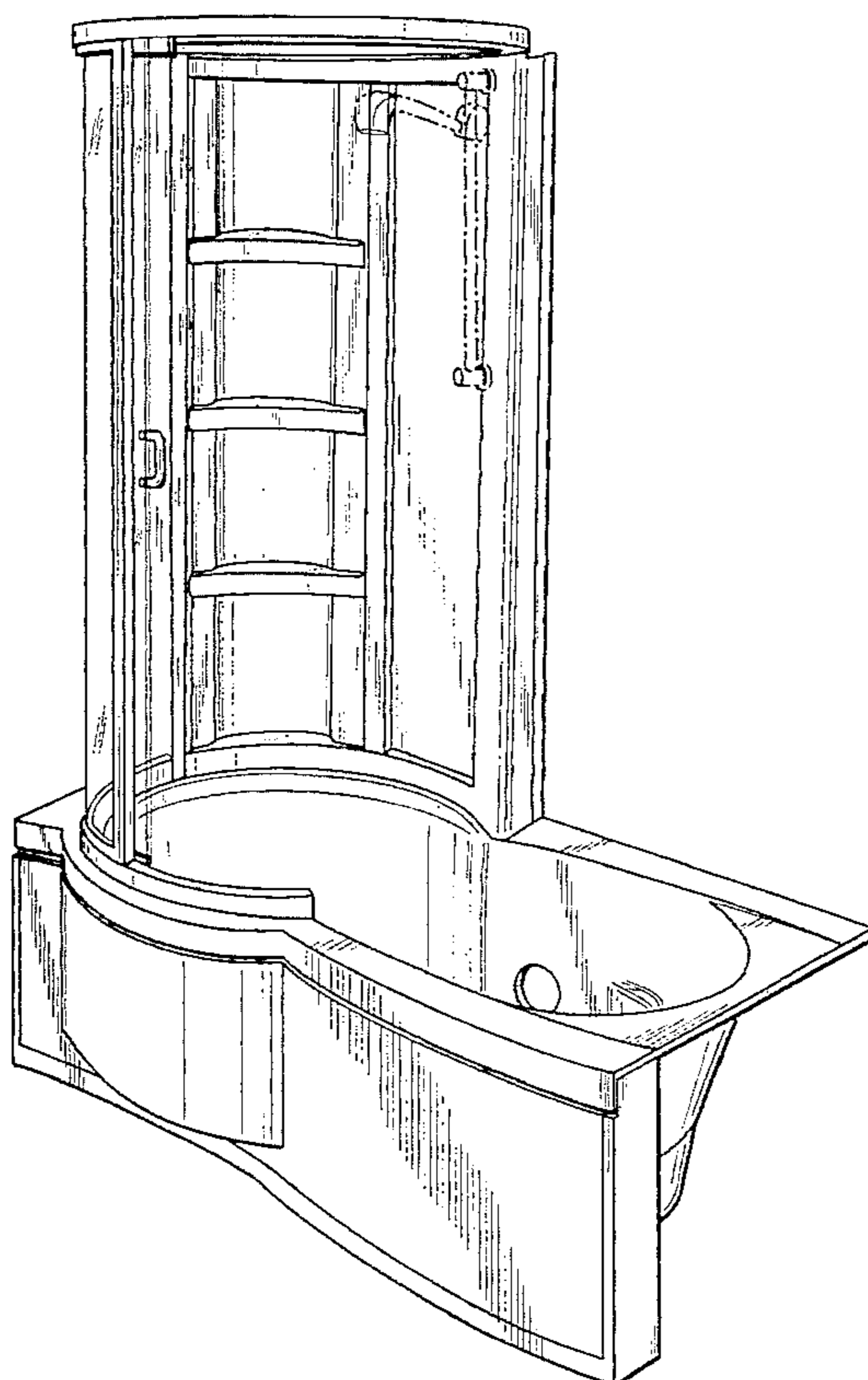

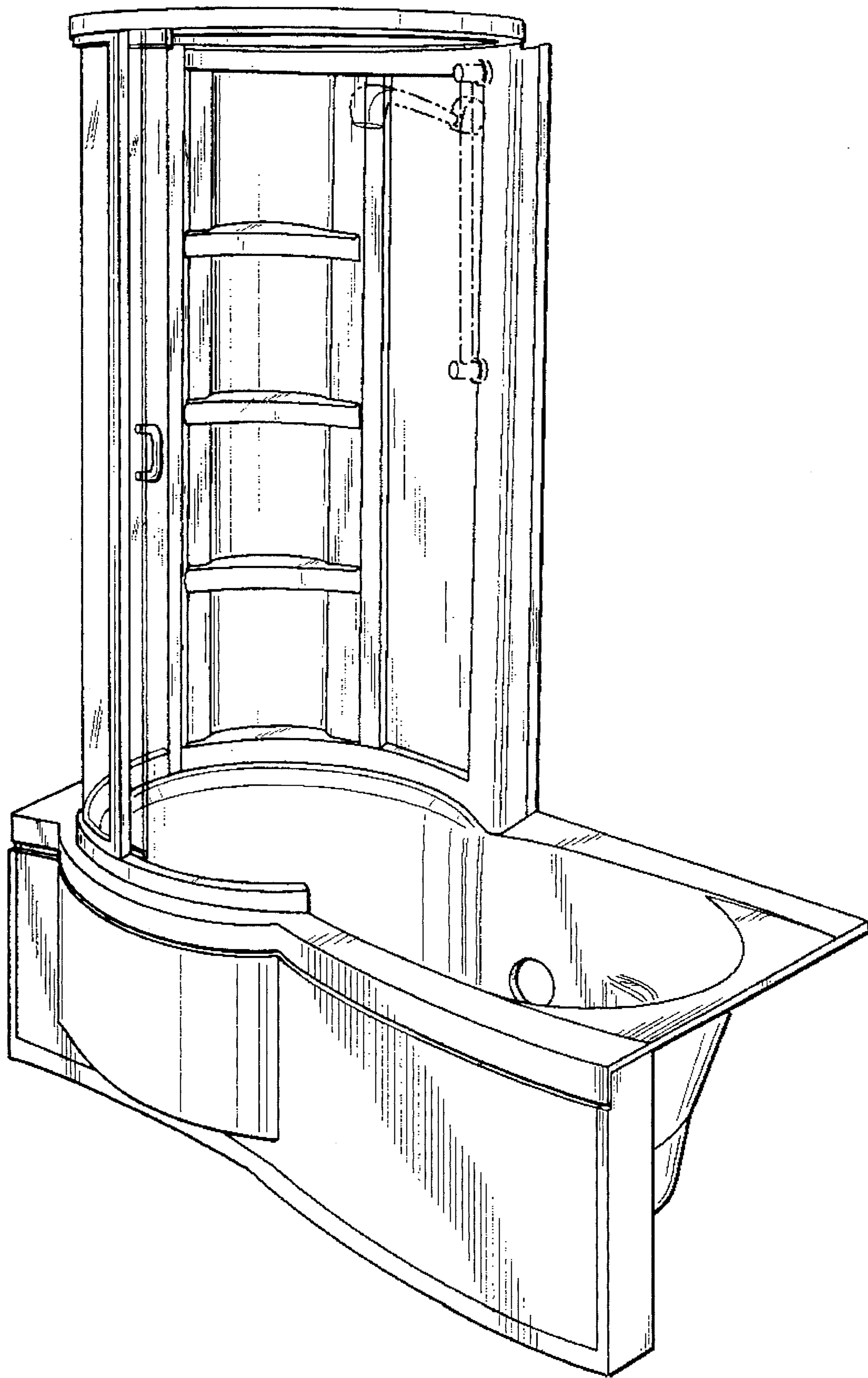

**FIG. 1**

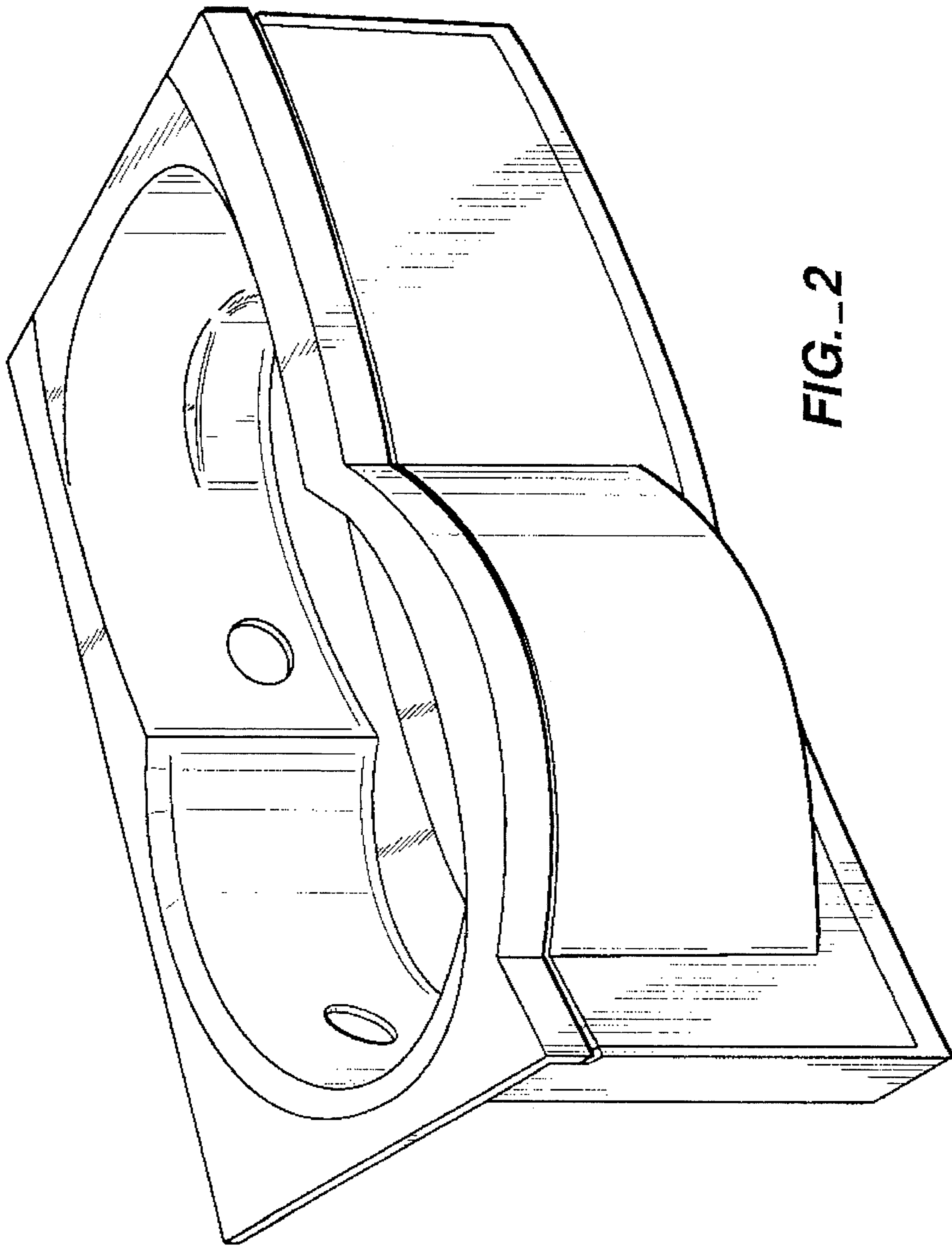

FIG. 2

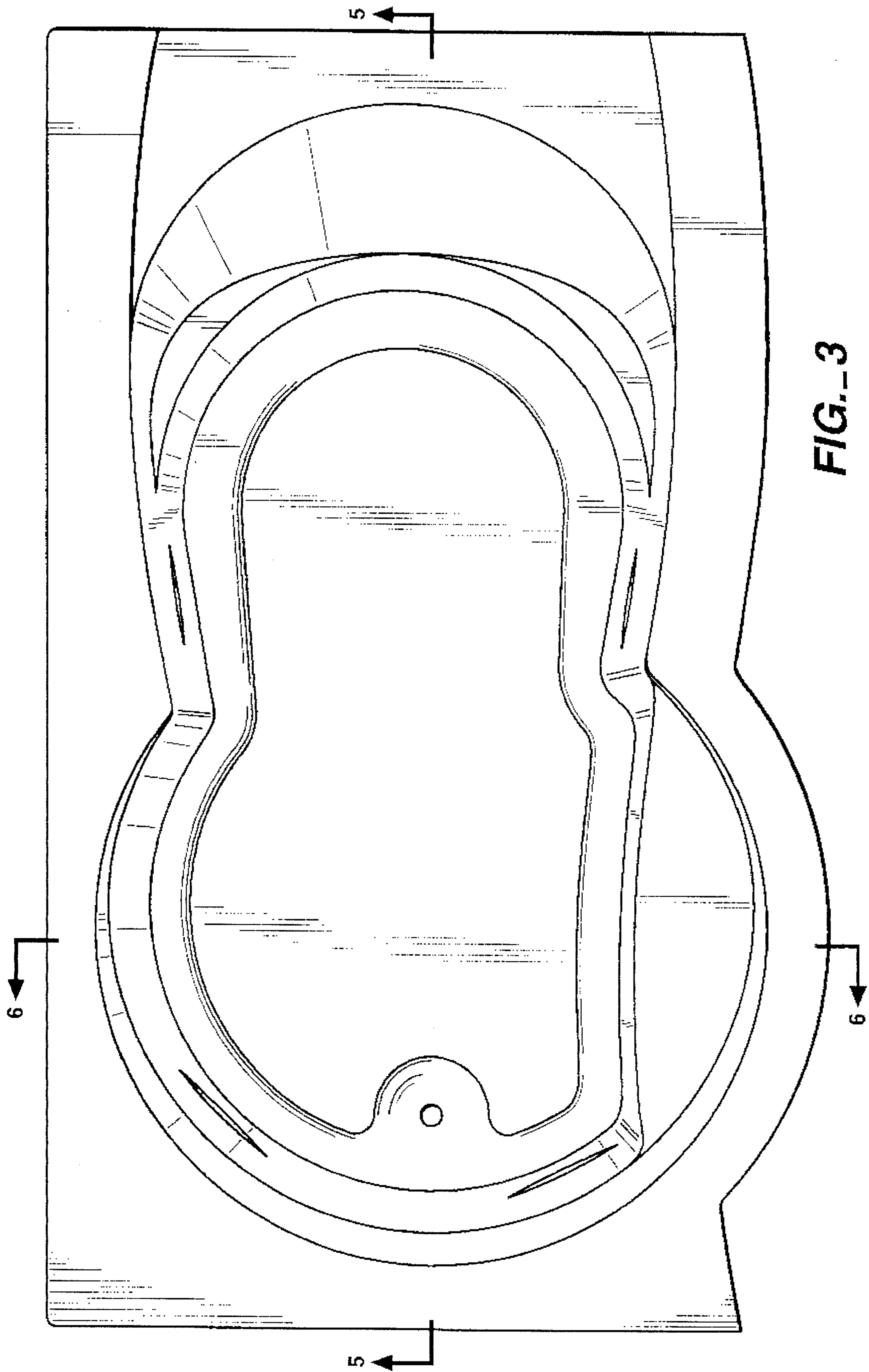

FIG. 3

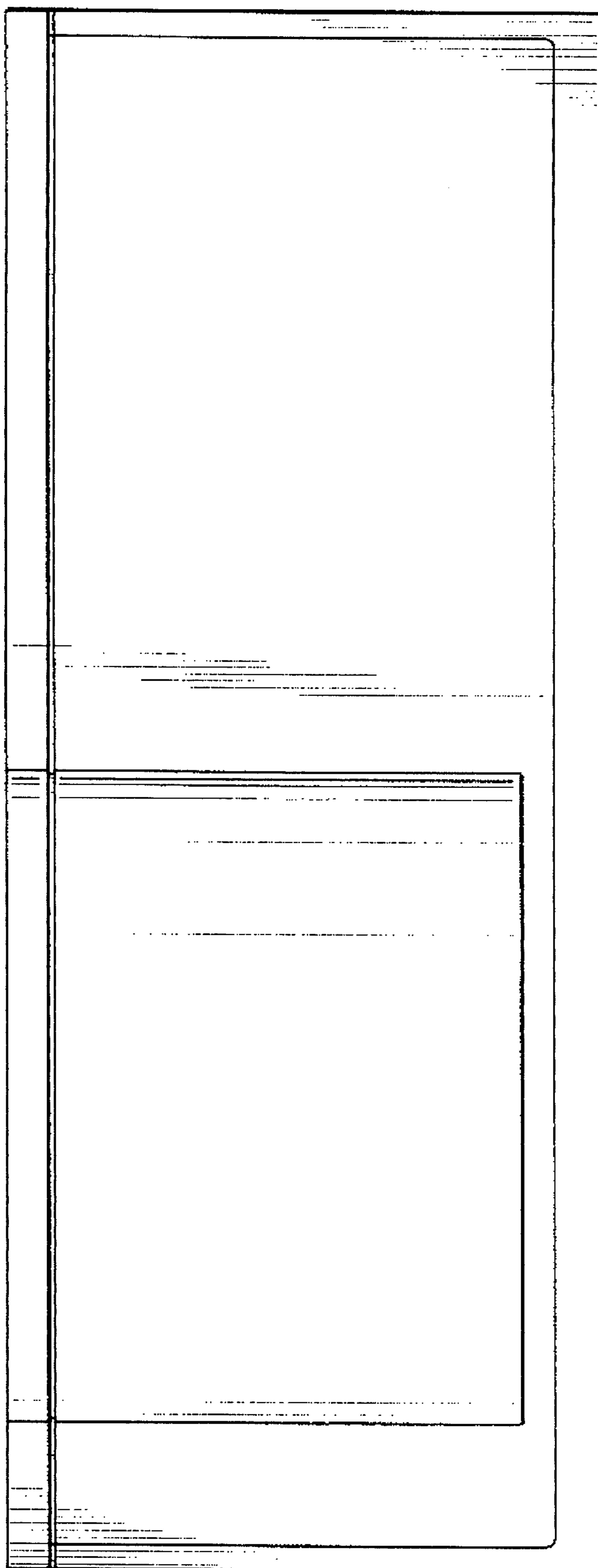

FIG. 4

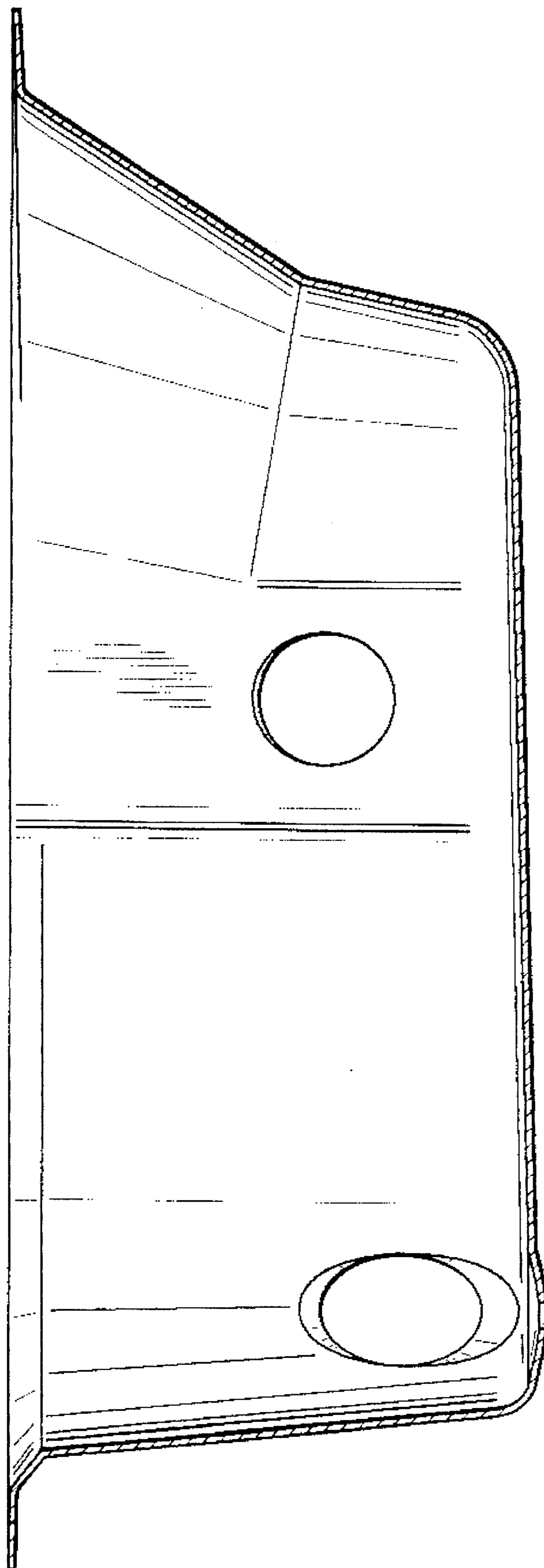
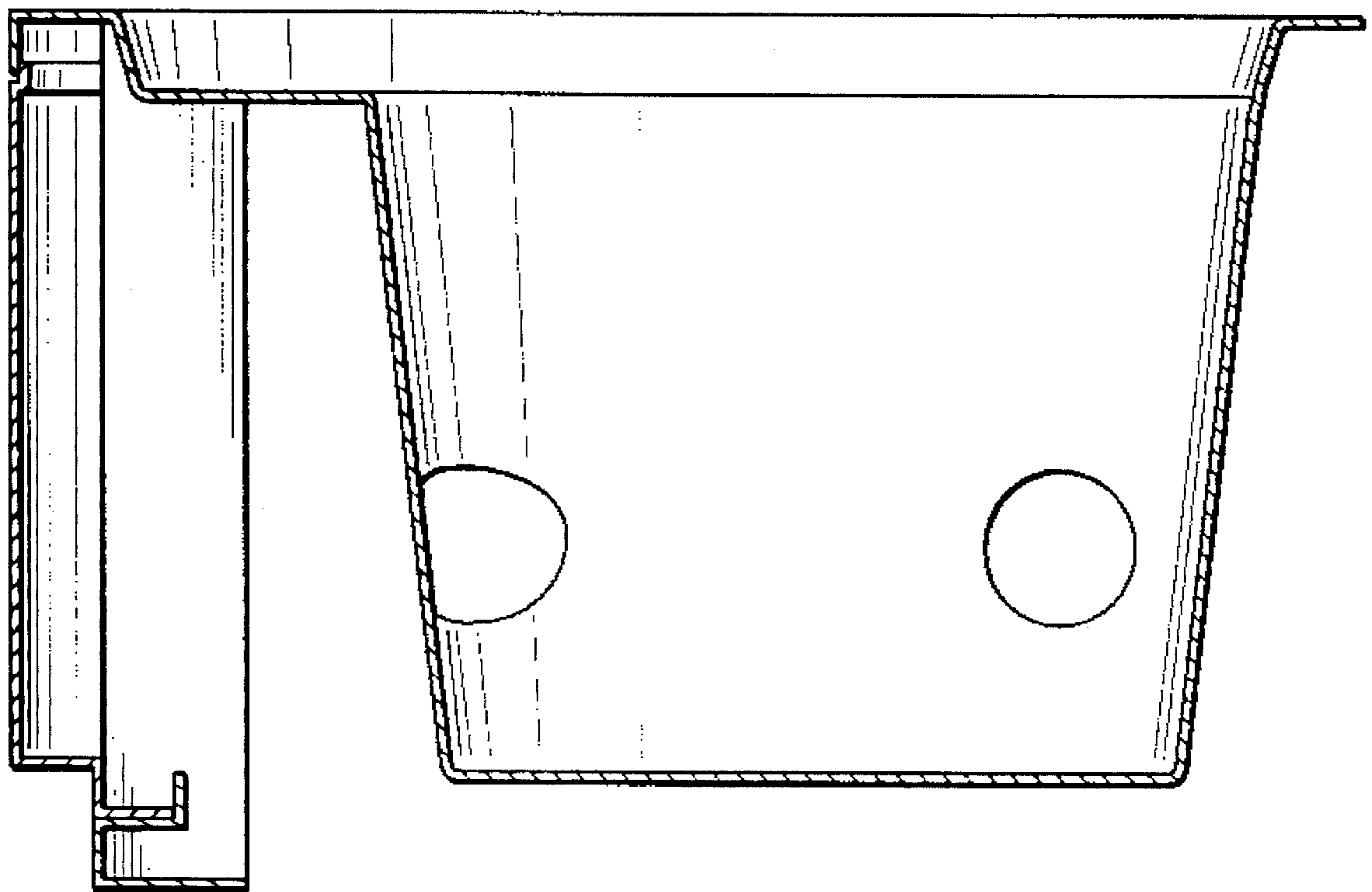
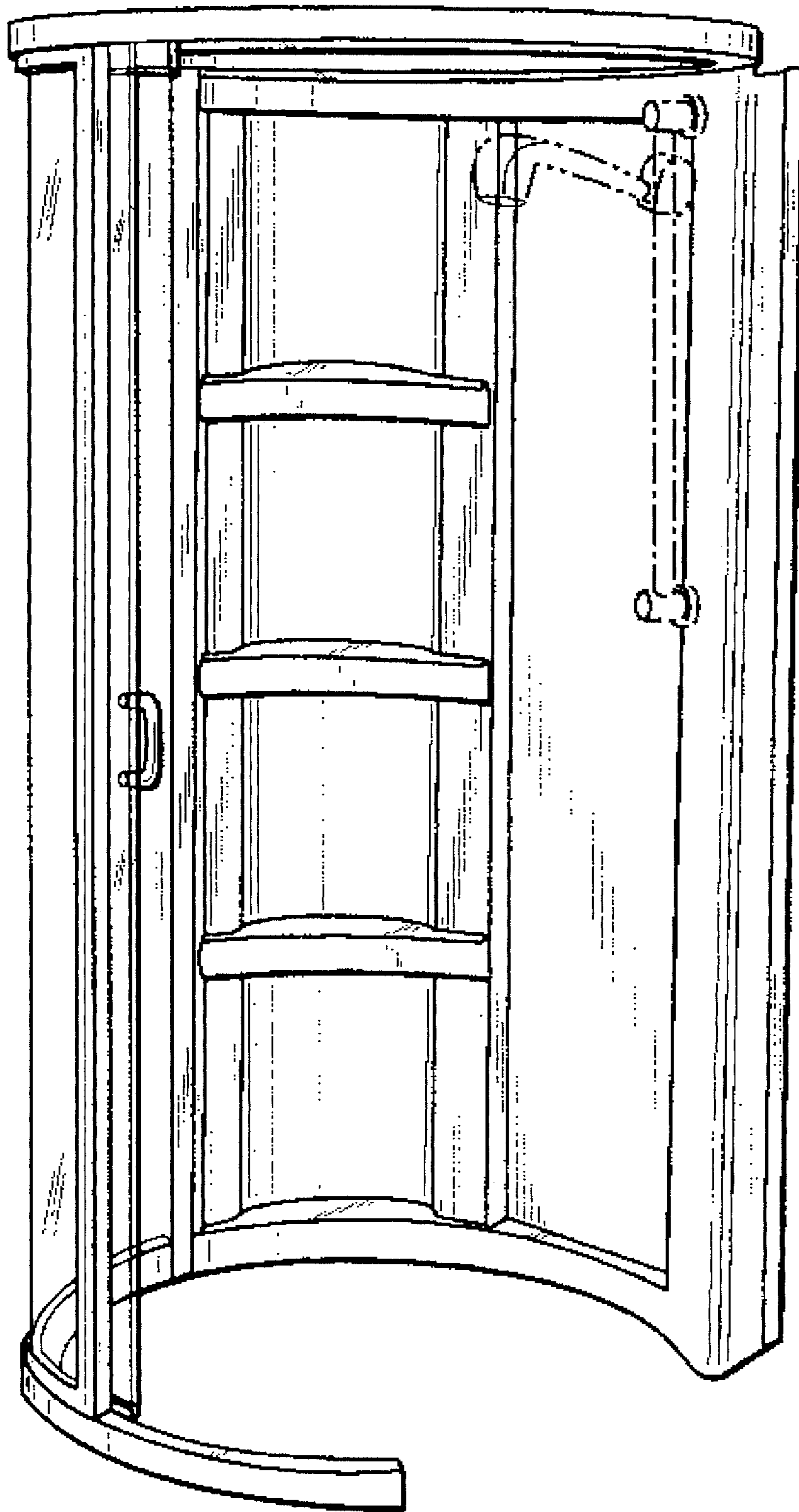

FIG. 5

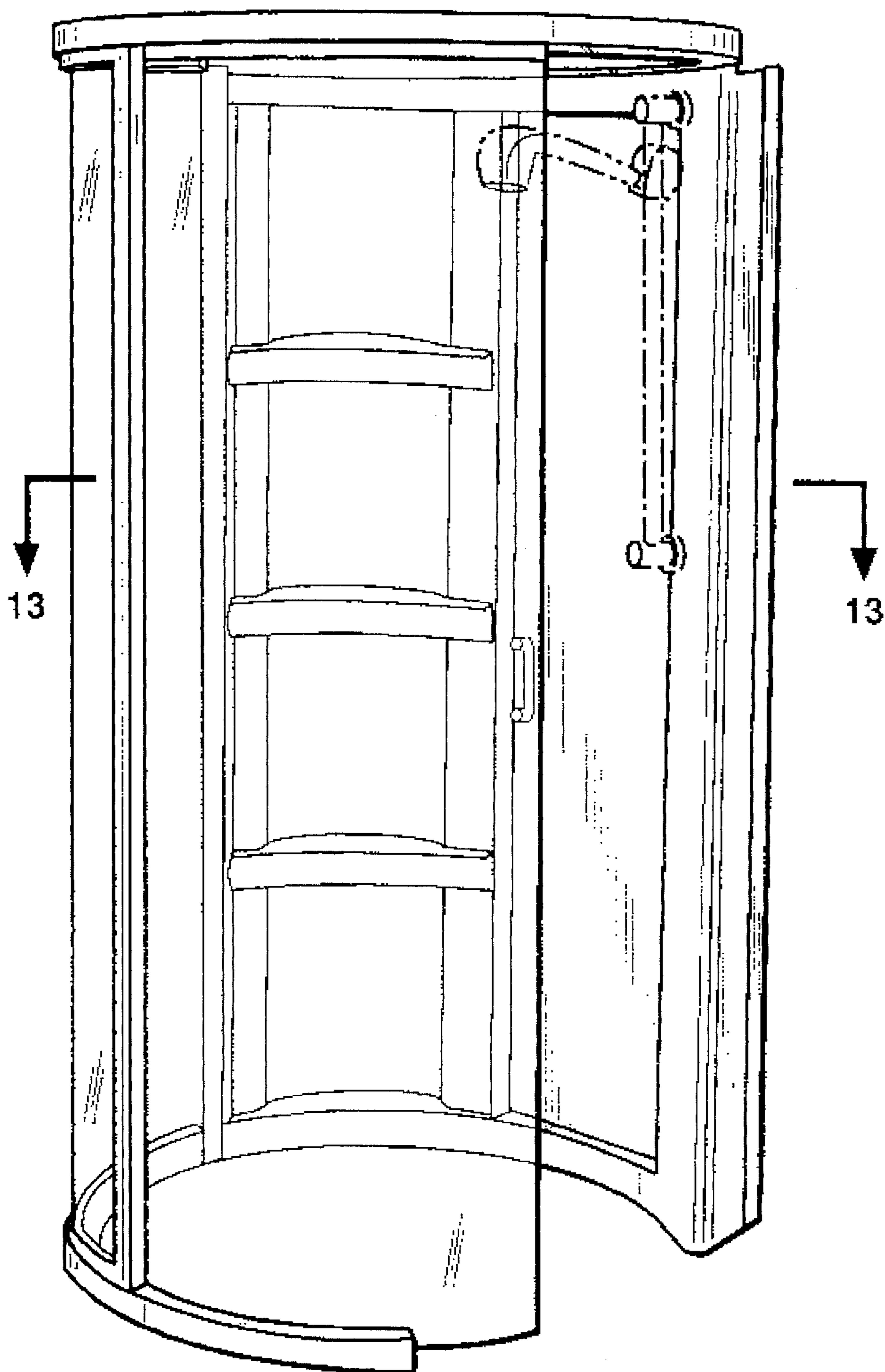

**FIG. 6**

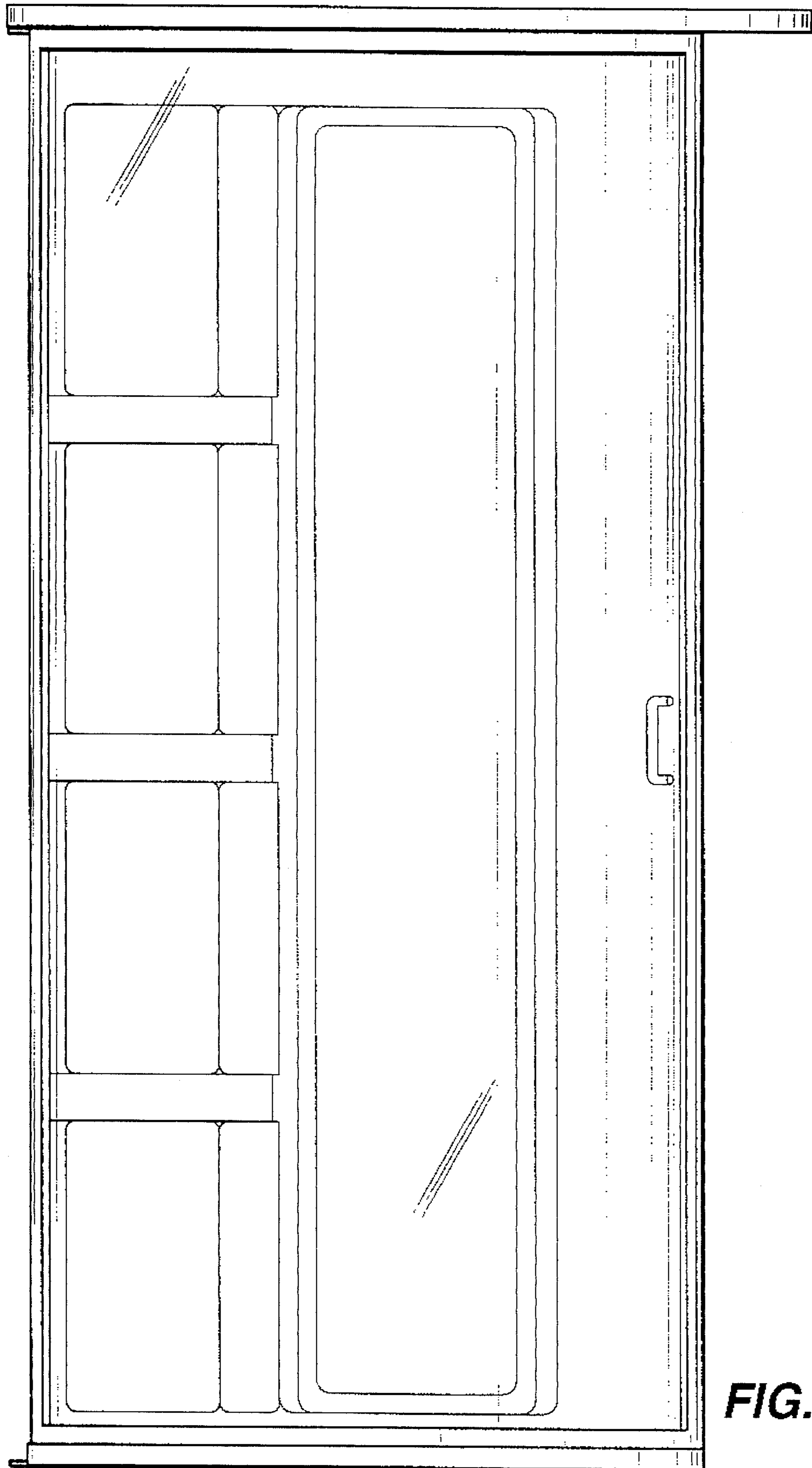

**FIG. 7**





**FIG. 8**



**FIG. 9**

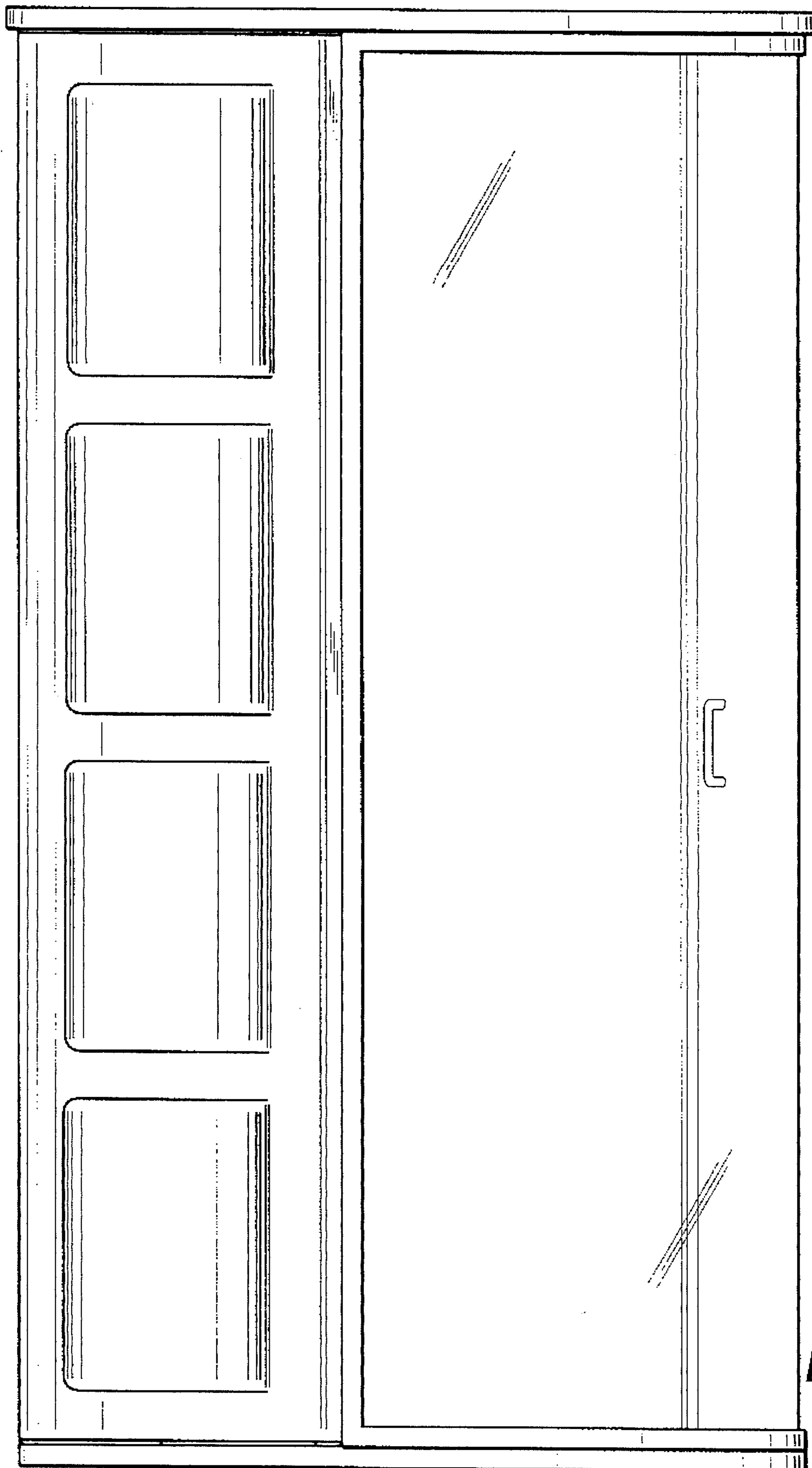
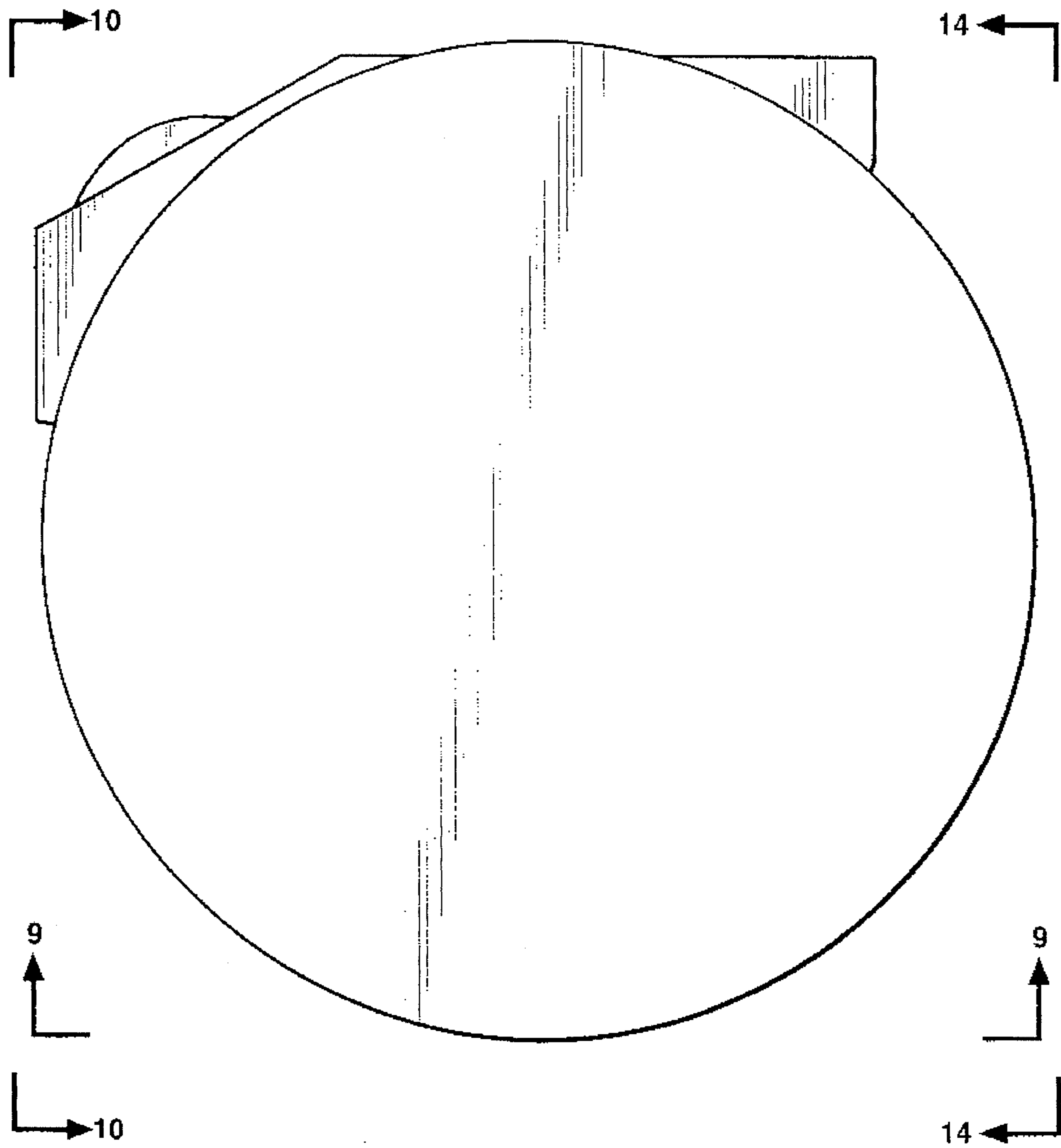

FIG. 10



**FIG. 11**

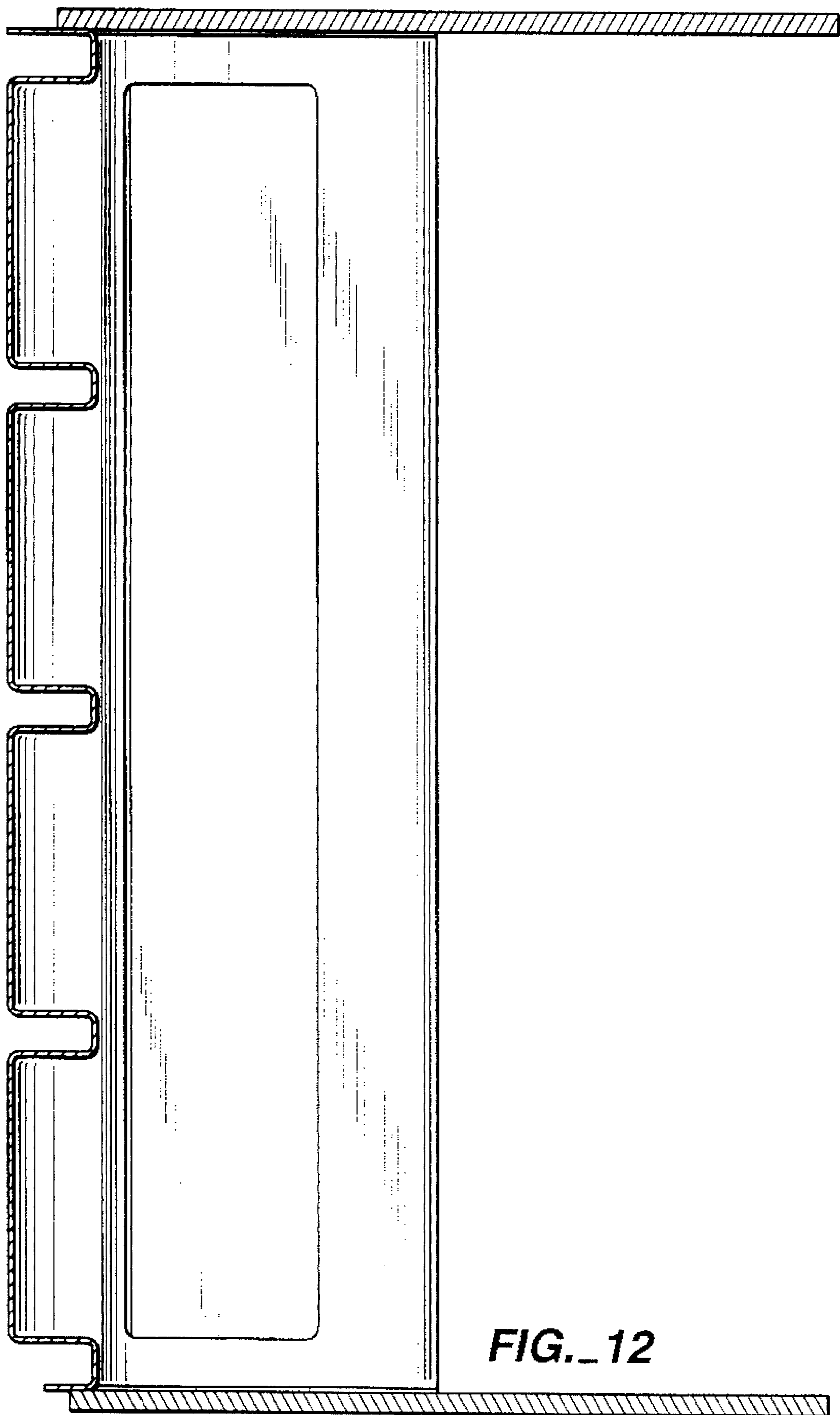
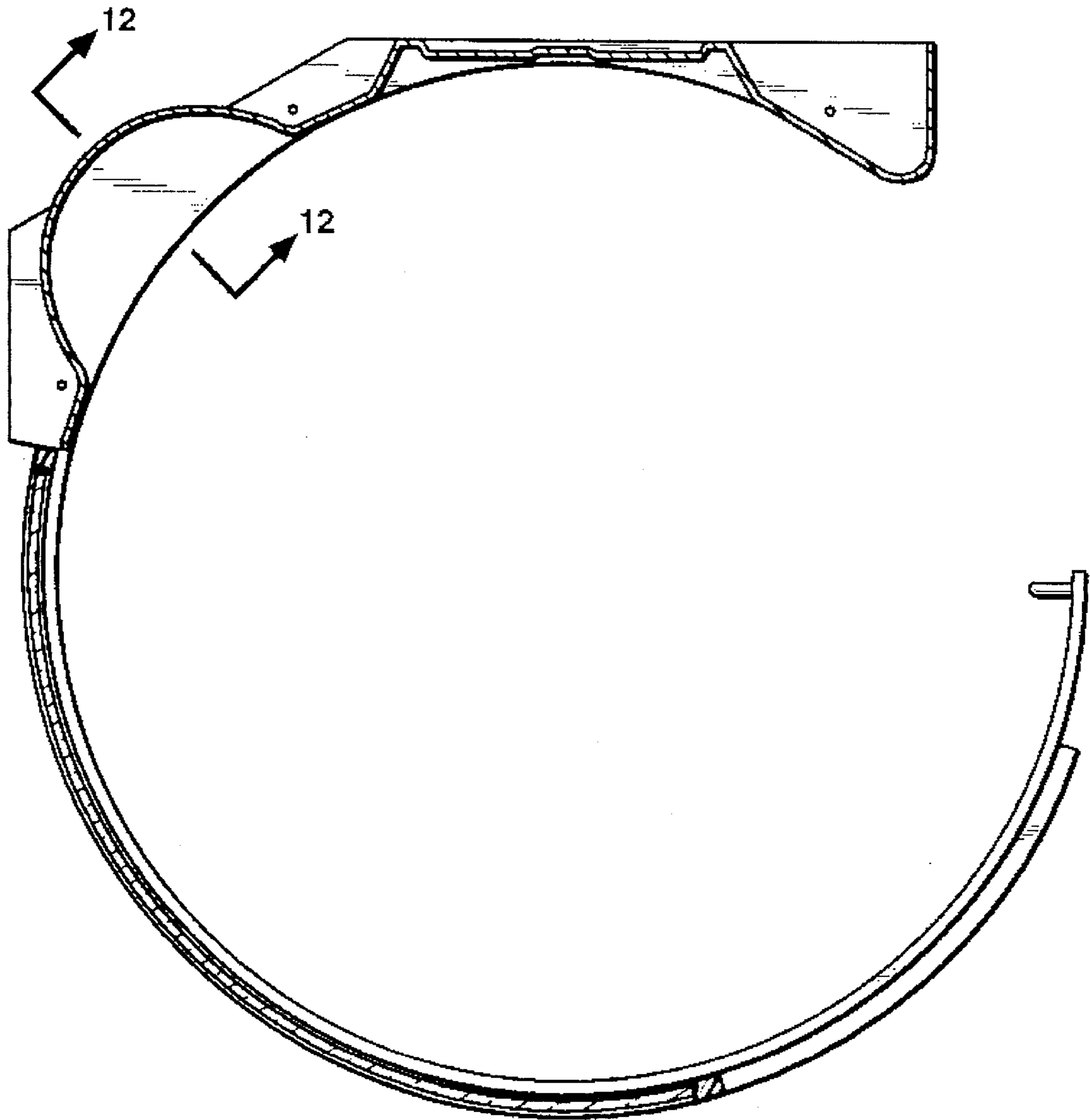

FIG. 12



**FIG. 13**

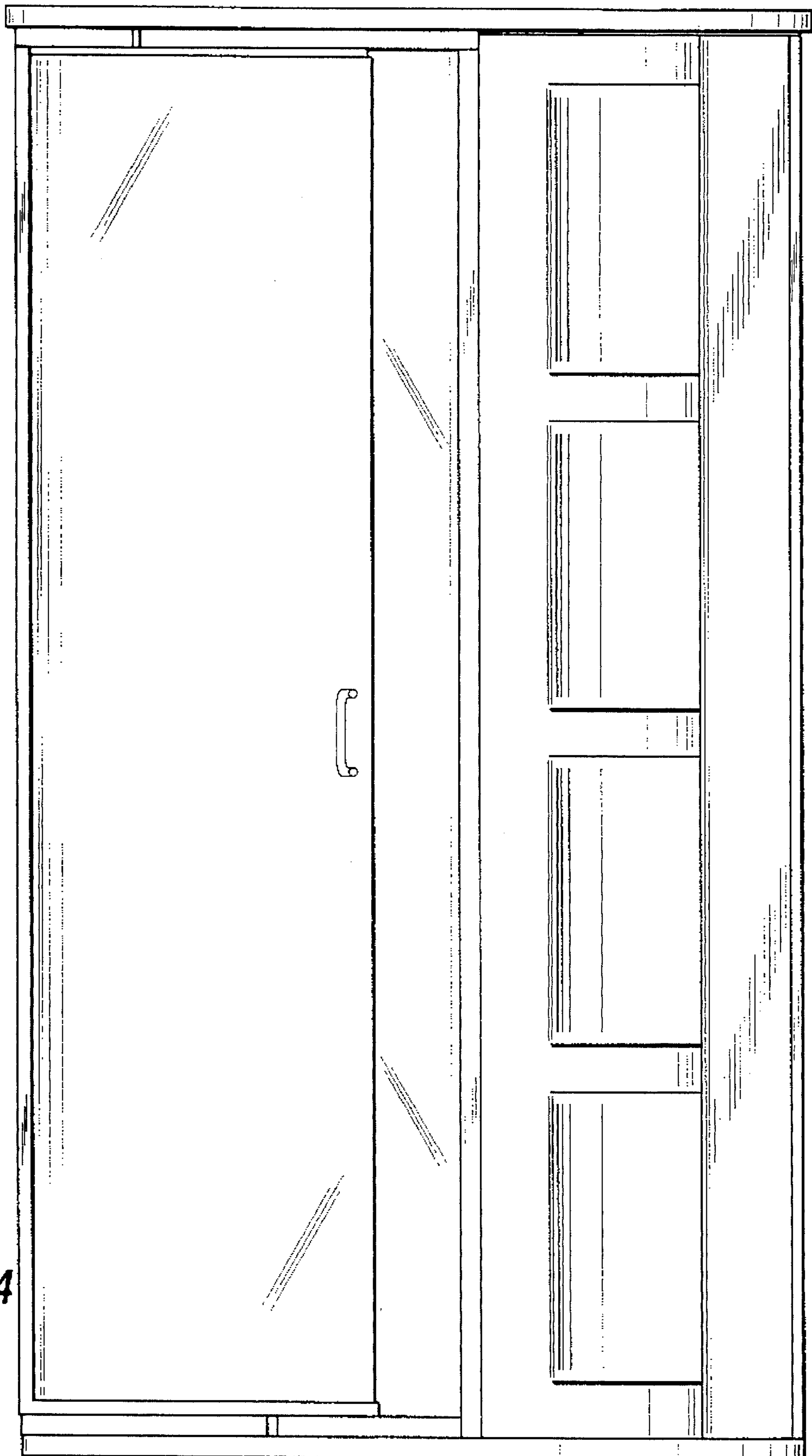

FIG. 14