



US00D372506S

United States Patent [19] Kino

[11] Patent Number: **Des. 372,506**

[45] Date of Patent: ****Aug. 6, 1996**

[54] WATER MACHINE GUN

[75] Inventor: **Moriya Kino**, Yokohama, Japan

[73] Assignee: **Royal Co., Ltd.**, Japan

[**] Term: **14 Years**

[21] Appl. No.: **34,144**

[22] Filed: **Jan. 25, 1995**

[30] Foreign Application Priority Data

Aug. 2, 1994 [JP] Japan 6-23477

[52] U.S. Cl. **D21/147**

[58] Field of Search D21/145, 146,
D21/147; 446/404, 405, 406, 407, 473;
222/79

[56] References Cited

U.S. PATENT DOCUMENTS

D. 169,039	3/1953	Hoffman	D21/147
D. 206,670	1/1967	Hirsch	D21/146
D. 286,660	11/1986	Barthropp	D21/147
D. 304,049	10/1989	Lee	D21/147
4,743,030	5/1988	Auer et al.	222/79
5,029,732	7/1991	Wong	222/79

OTHER PUBLICATIONS

“Sunny Park” catalogue, issued Jun. 1993–1994 by Royal Co., Ltd.

A catalogue, issued 1992–1993 by Tsukada Original.

Primary Examiner—Terry A. Wallace

Assistant Examiner—R. Barkai

Attorney, Agent, or Firm—Ostrolenk, Faber, Gerb and Sof-fen, LLP

[57] CLAIM

The ornamental design for a water machine gun, as shown and described.

DESCRIPTION

FIG. 1 is a top plan view of a water machine gun showing my new design;

FIG. 2 is a front elevational view and is also a mirror image of rear elevational view thereof;

FIG. 3 is a left side elevational view thereof;

FIG. 4 is a right side elevational view thereof;

FIG. 5 is a bottom plan view thereof;

FIG. 6 is a front elevational view thereof in an operating condition; and,

FIG. 7 is a section view taken in the direction of the arrows on the line VII—VII of FIG. 3.

1 Claim, 4 Drawing Sheets

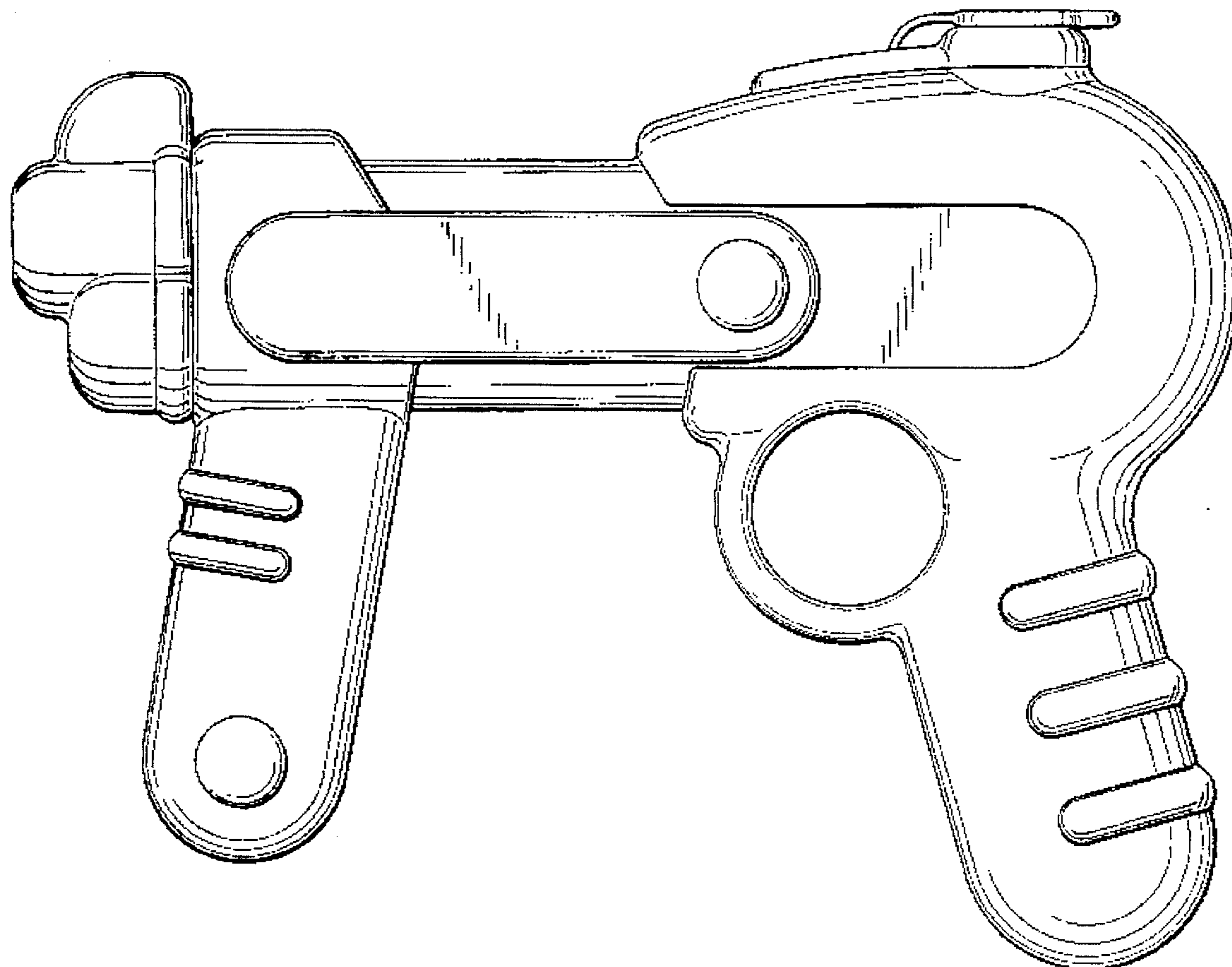

Fig. 1

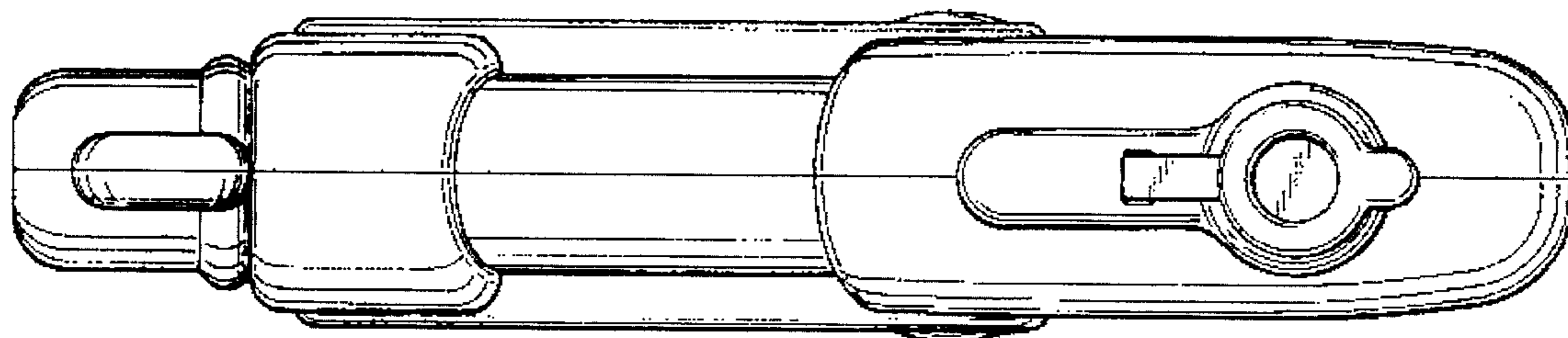

Fig. 2

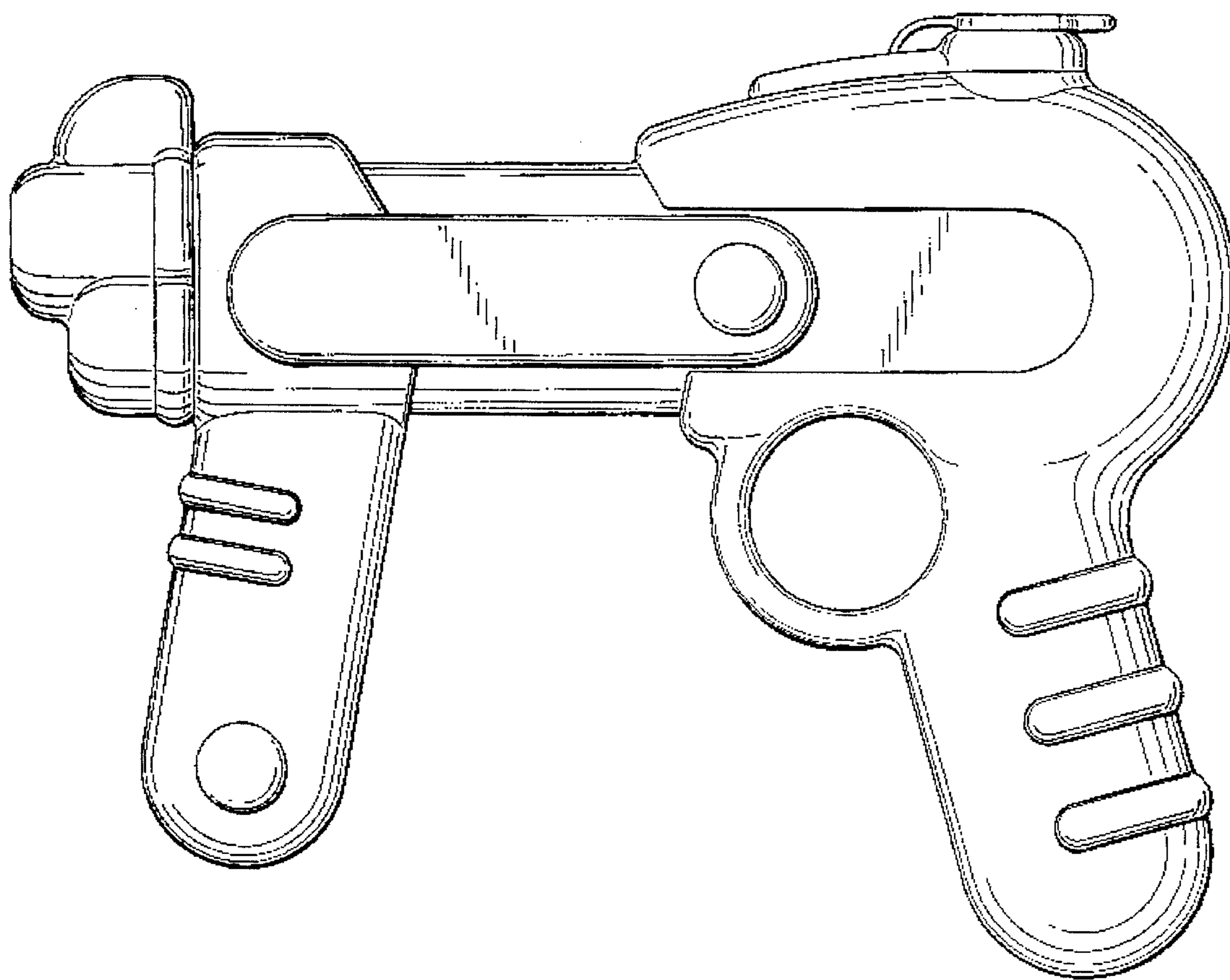

Fig. 3

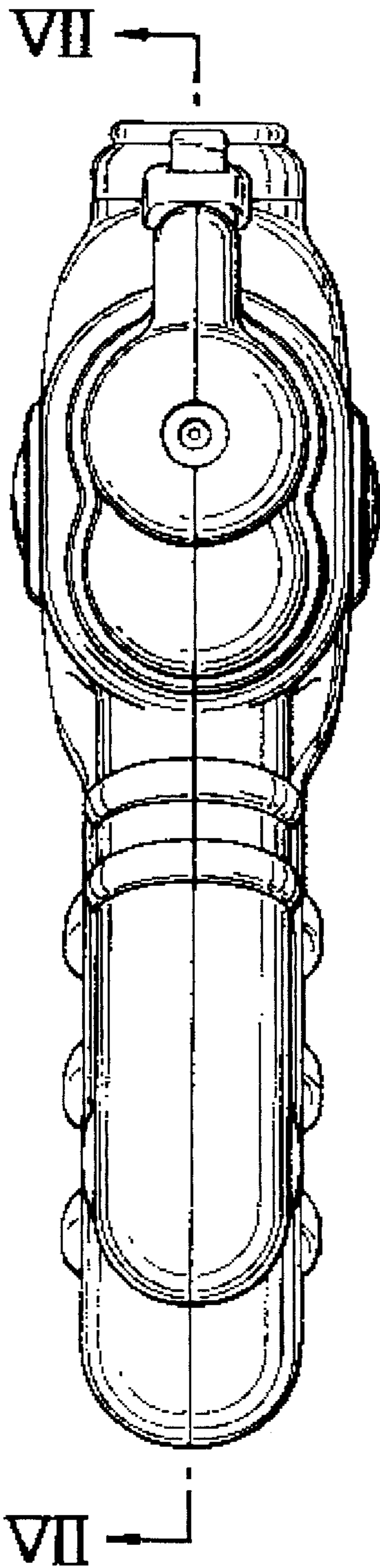

Fig. 4

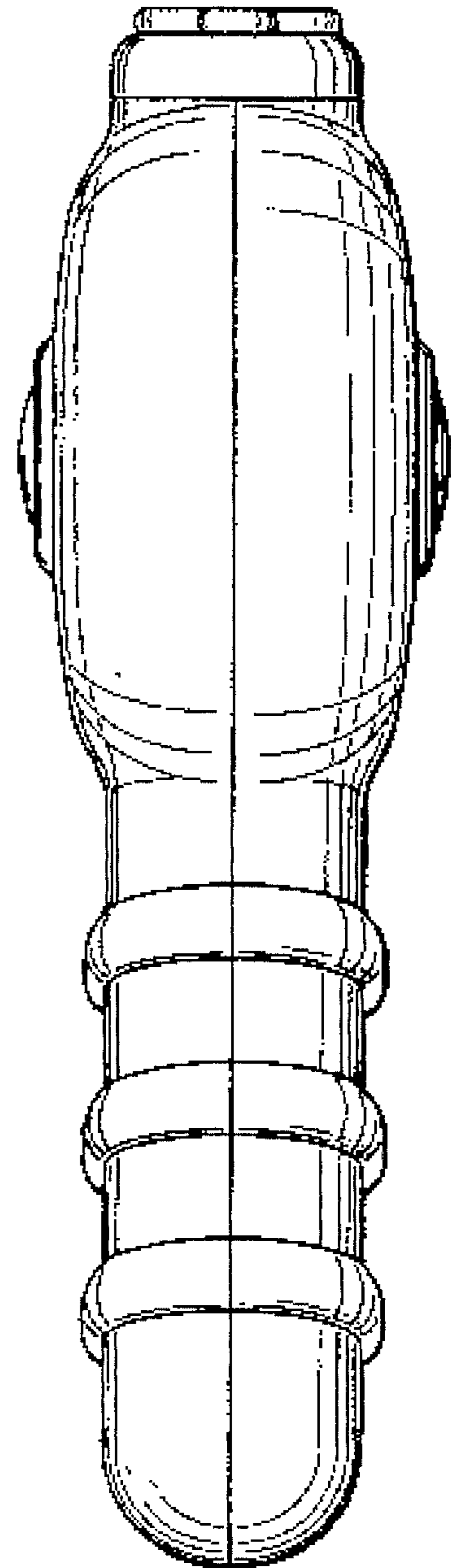

Fig. 5

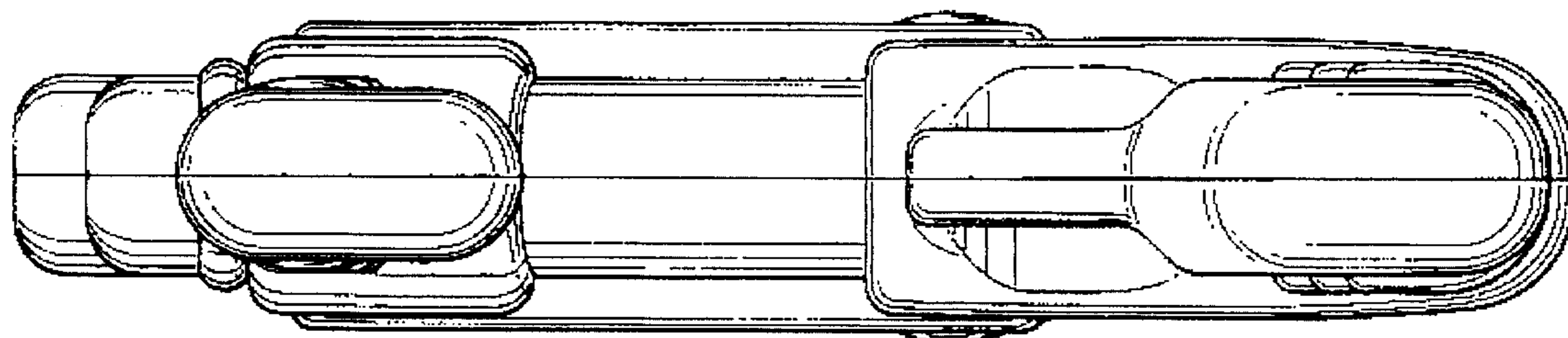

Fig. 6

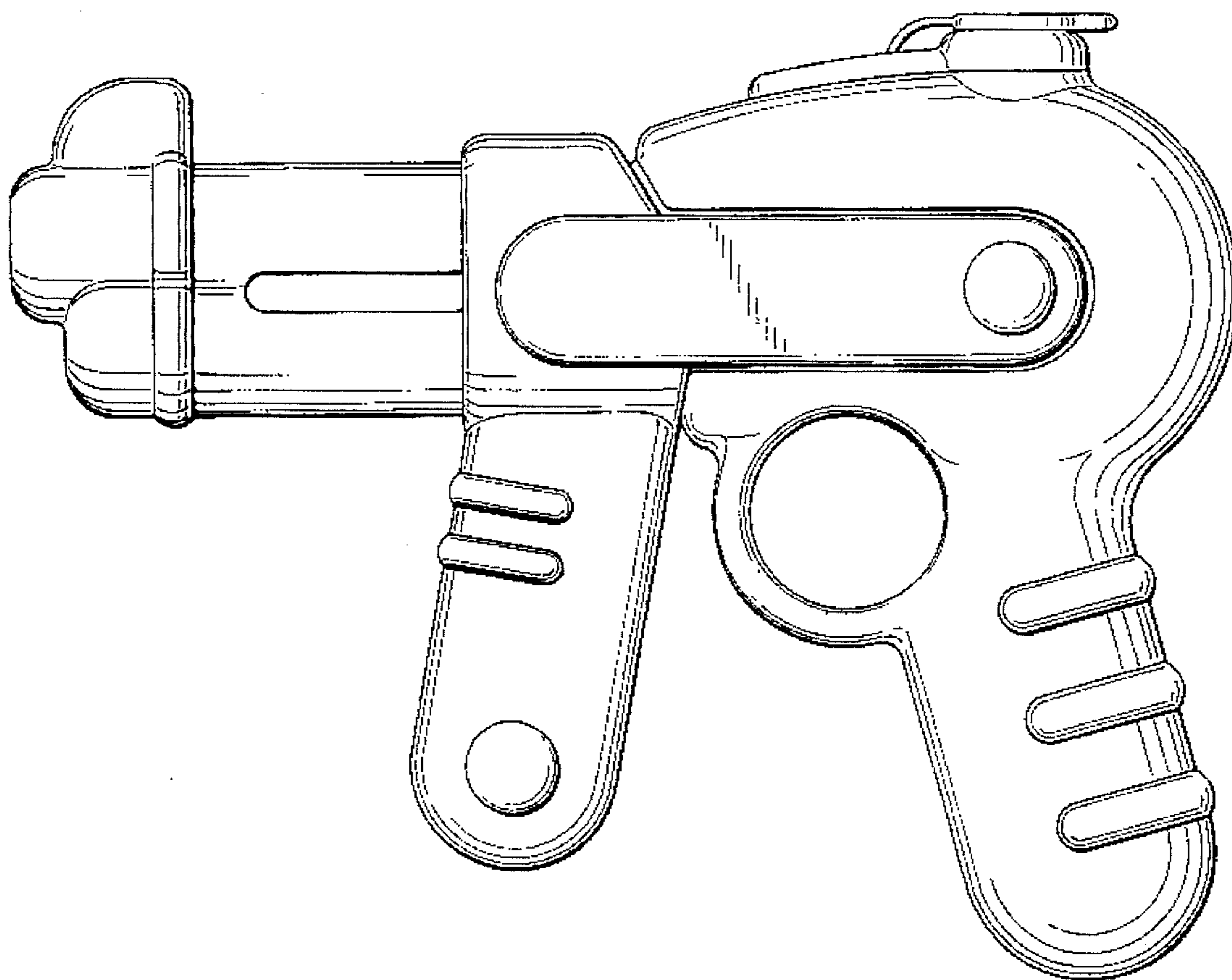

Fig. 7

