



US00D372490S

United States Patent [19]

Sheffield et al.

[11] Patent Number: **Des. 372,490**

[45] Date of Patent: ****Aug. 6, 1996**

[54] **SAFETY GLASSES AND PRESCRIPTION LENS INSERT COMBINATION**

[75] Inventors: **Keith W. Sheffield**, Kent, England;
John Chin, Tainan, Taiwan

[73] Assignee: **Crews, Inc.**, Memphis, Tenn.

[**] Term: **14 Years**

[21] Appl. No.: **40,485**

[22] Filed: **Jun. 20, 1995**

[52] U.S. Cl. **D16/325**

[58] **Field of Search** D16/100, 300,
D16/101, 304, 306, 309, 310, 311, 312,
313, 314, 315, 317, 318, 326, 327, 328,
329, 339, 340; 2/428, 430, 432, 436, 444,
448, 449; 351/44, 47, 48, 51, 52, 57, 58,
61, 66, 111, 123, 157, 158, 171

[56] **References Cited**

U.S. PATENT DOCUMENTS

D. 285,020	8/1986	Schmidthaler	D16/313
D. 295,870	5/1988	Laterre	D16/313
D. 315,163	3/1991	Hirschman	D16/313

D. 351,850	10/1994	Bolle	D16/312
4,023,214	5/1977	Waldherr	2/444
4,930,163	6/1990	King	2/444
5,410,763	5/1995	Bolle	2/444
5,412,438	5/1995	Bolle	.	
5,428,407	6/1995	Sheffield	351/58

Primary Examiner—Sandra L. Morris
Assistant Examiner—R. Barkai
Attorney, Agent, or Firm—Edwin E. Greigg; Ronald E. Greigg

[57] **CLAIM**

The ornamental design for safety glasses and prescription lens insert combination, as shown and described.

DESCRIPTION

FIG. 1 is a perspective view showing our new design;
FIG. 2 is a front view;
FIG. 3 is a back view;
FIG. 4 is a top view;
FIG. 5 is a right side elevational view, the side opposite being a mirror image; and,
FIG. 6 is an exploded view shown for clarity of illustration.

1 Claim, 3 Drawing Sheets

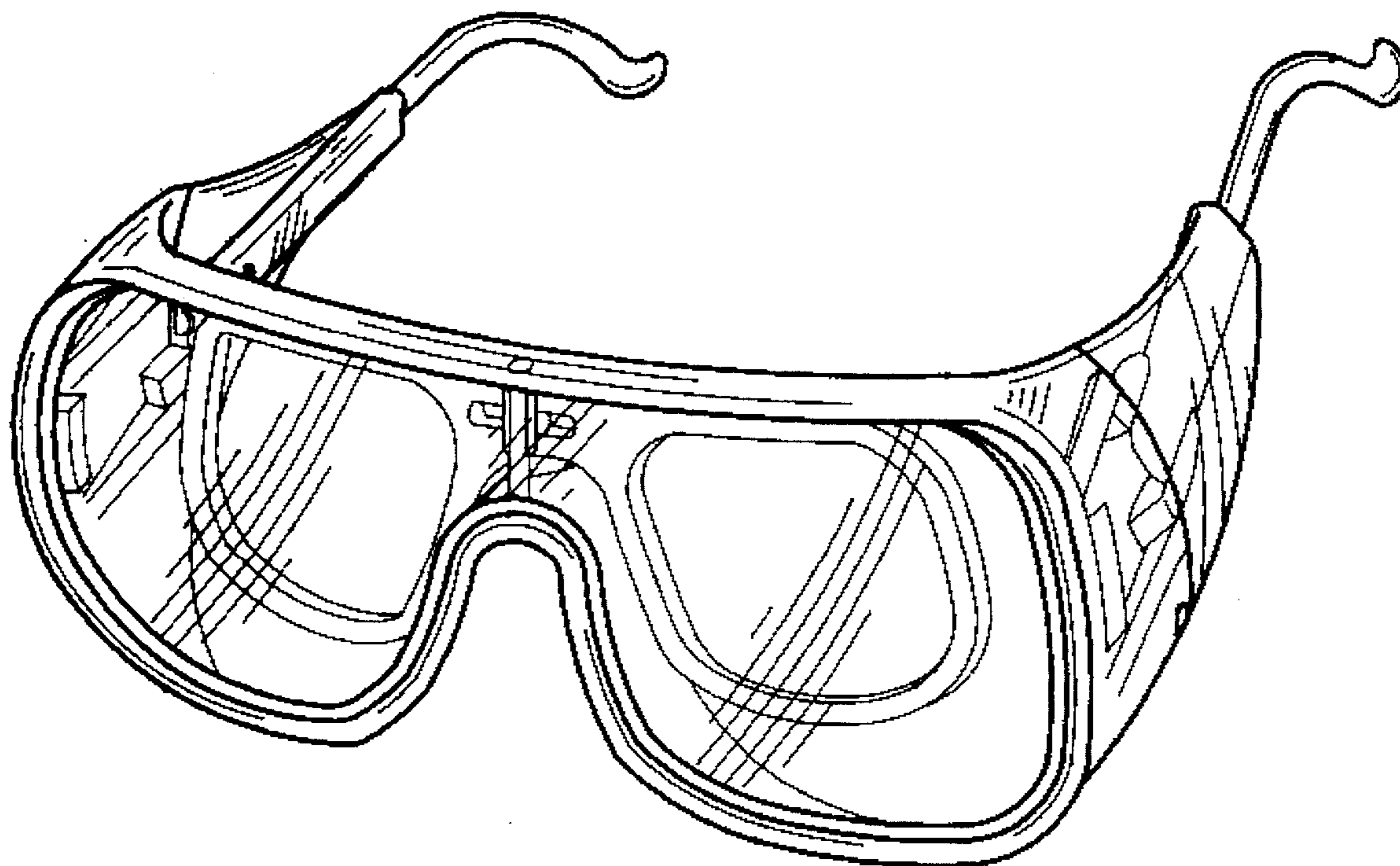

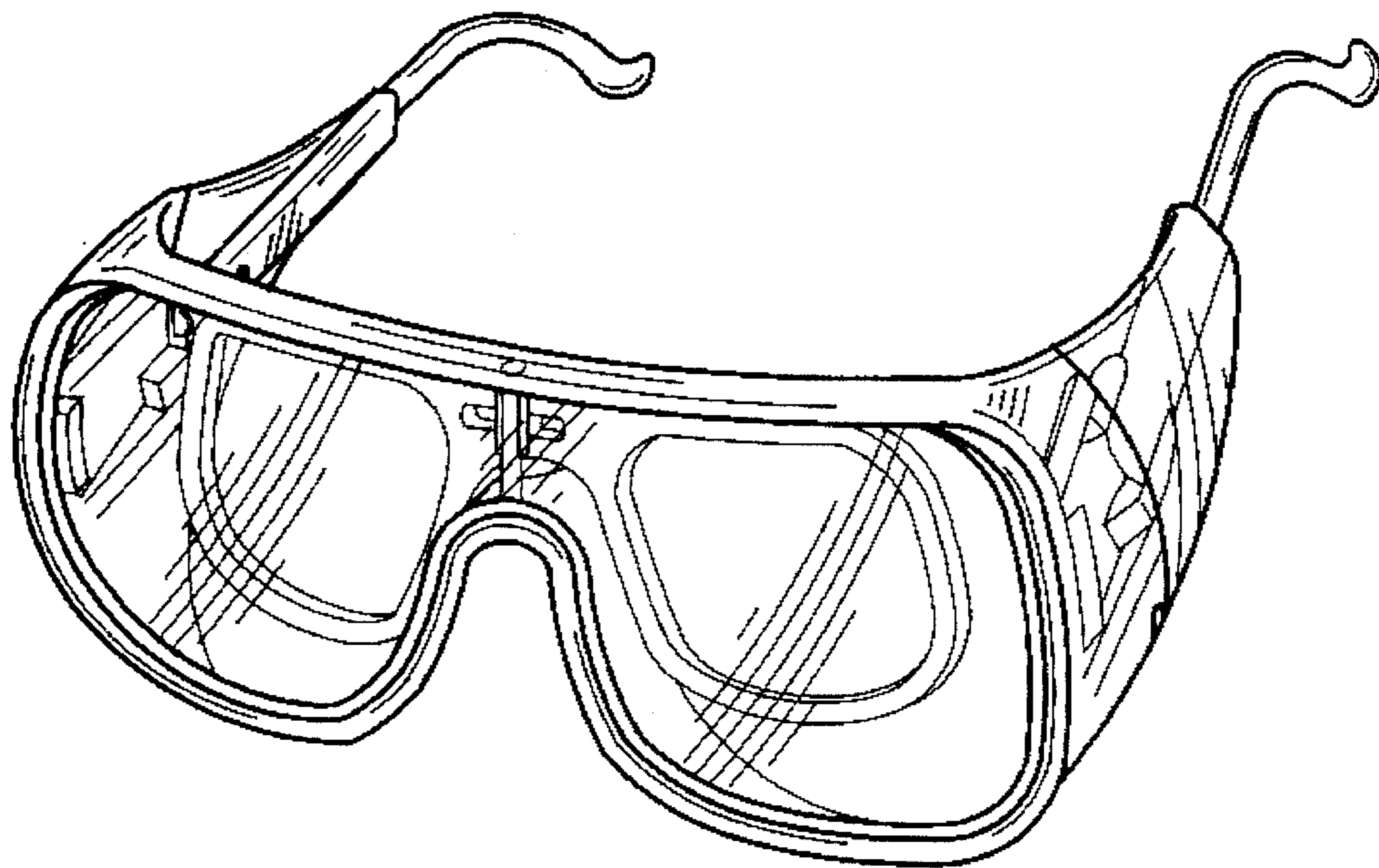

FIG. 1

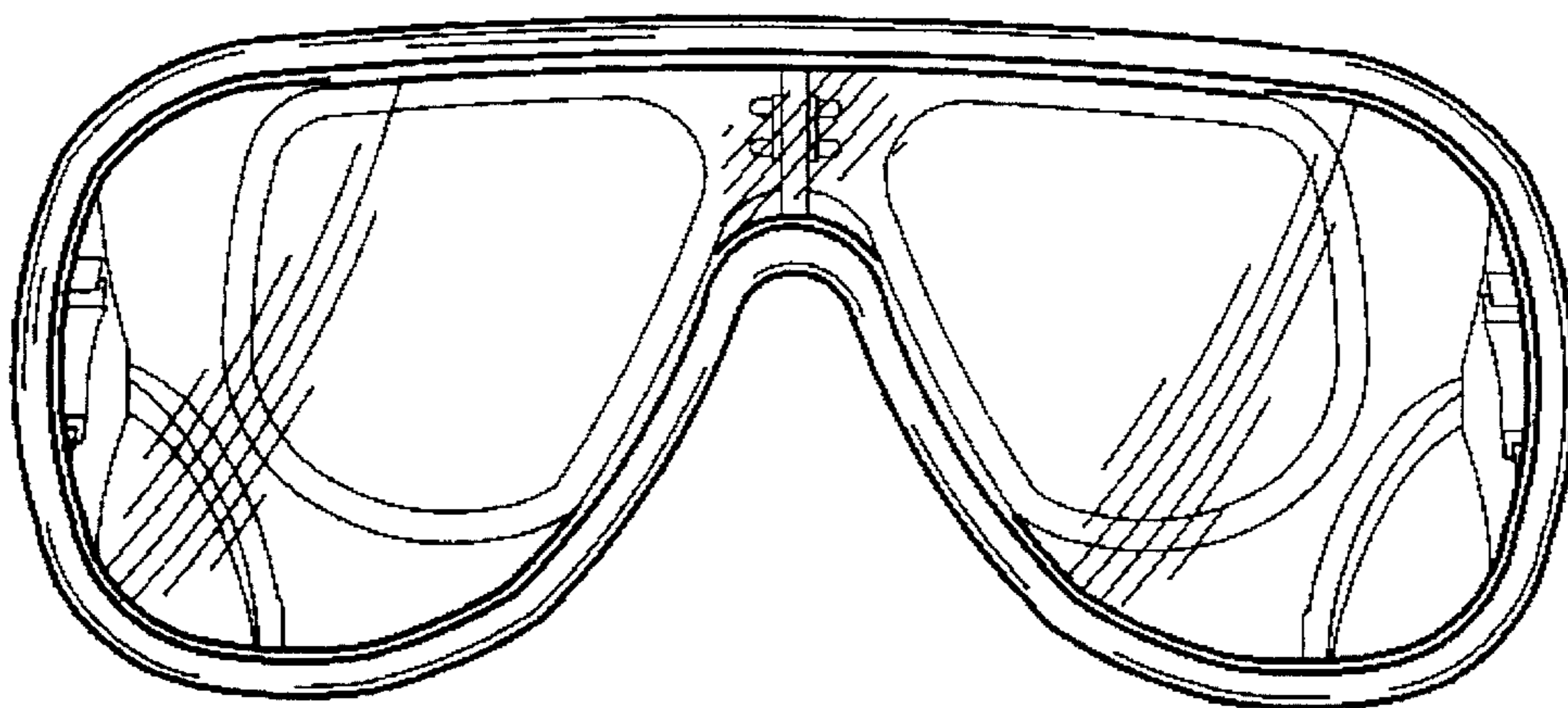

FIG. 2

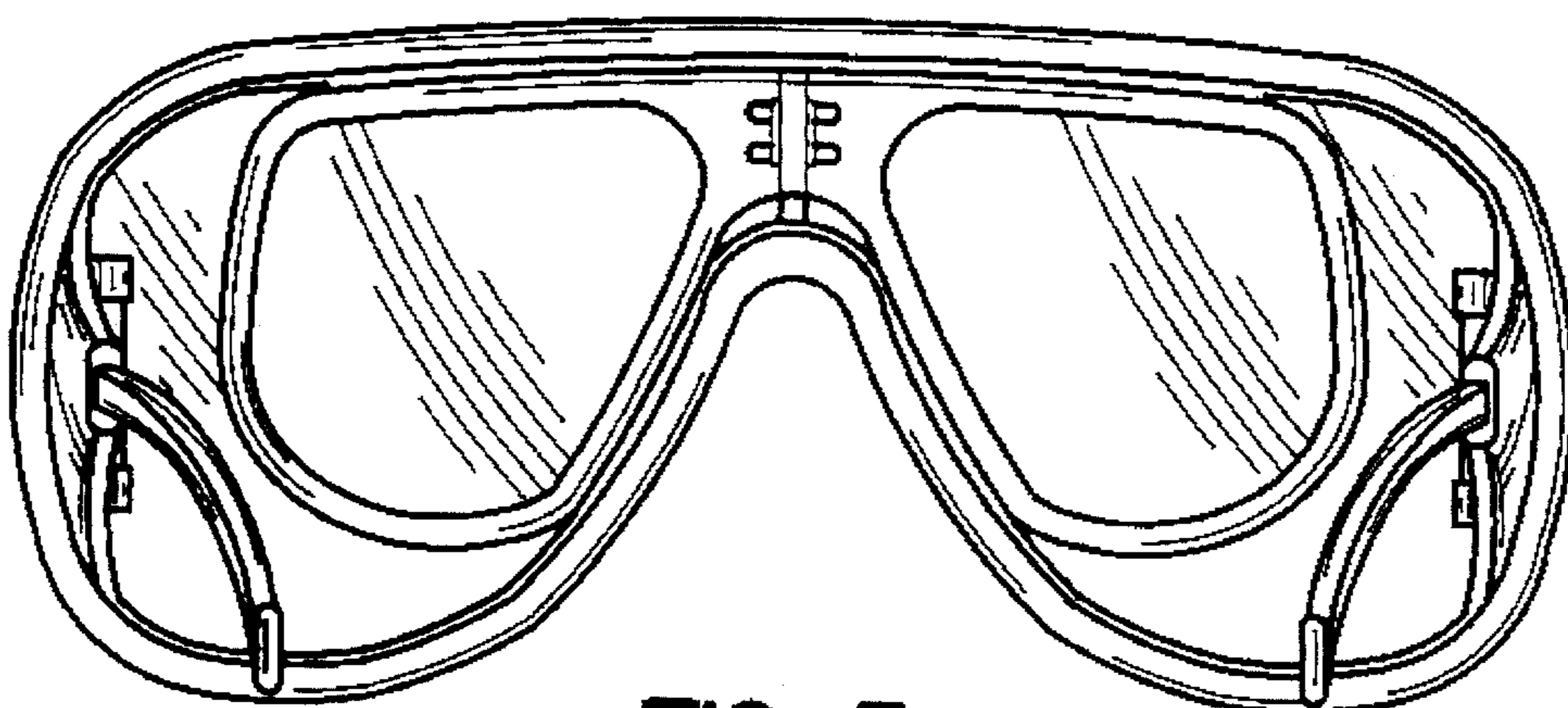

FIG. 3

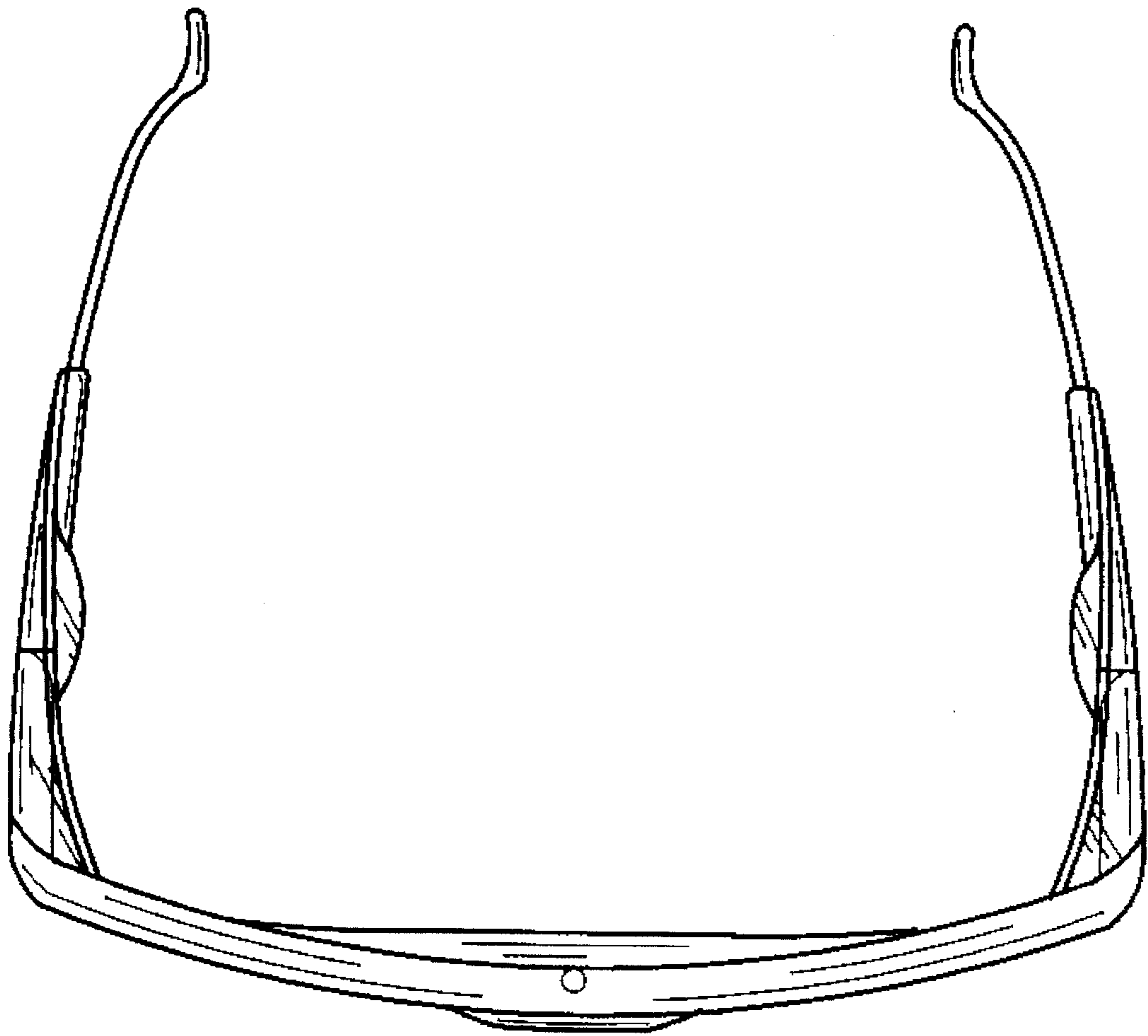

FIG. 4

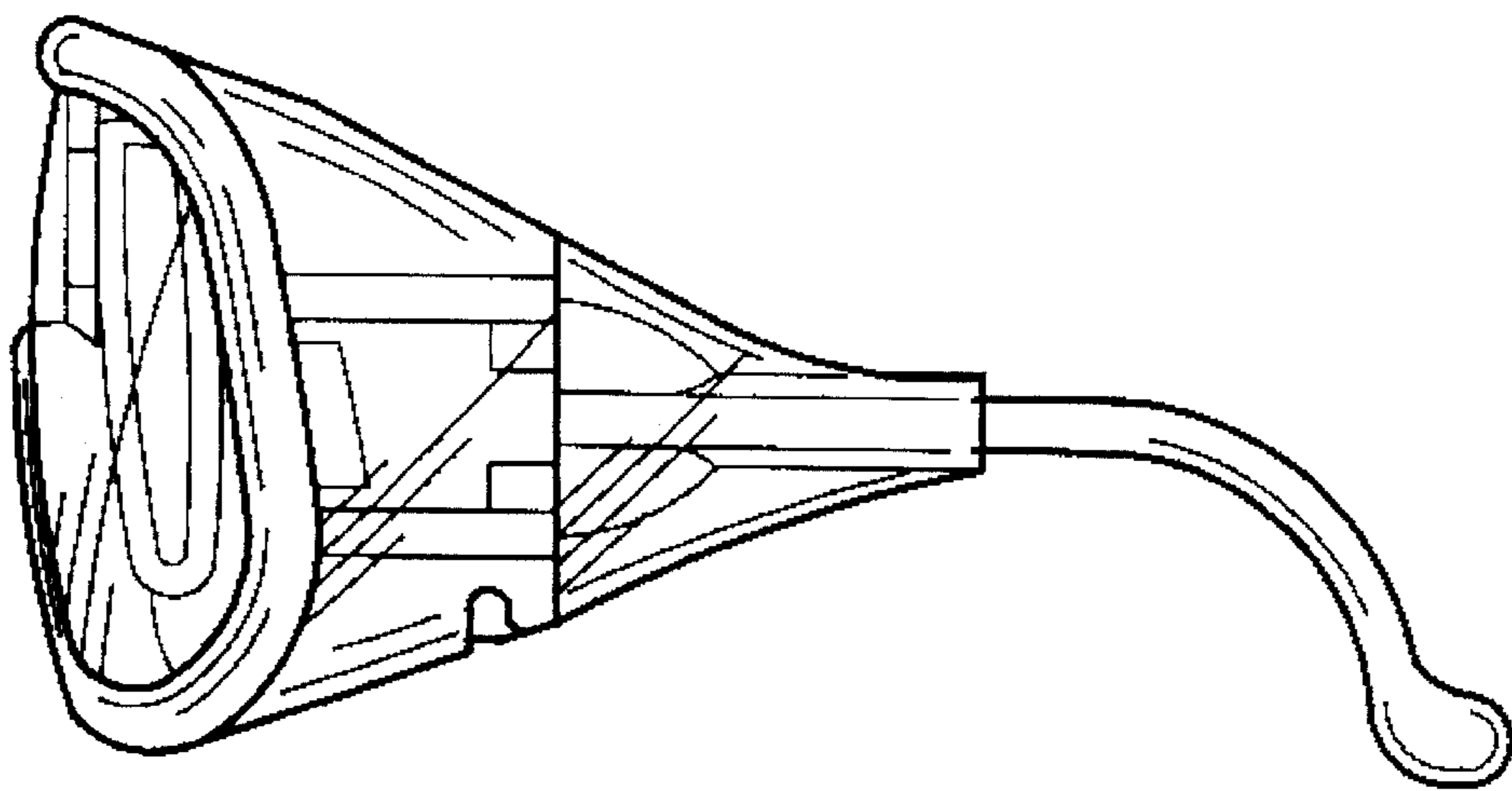

FIG. 5

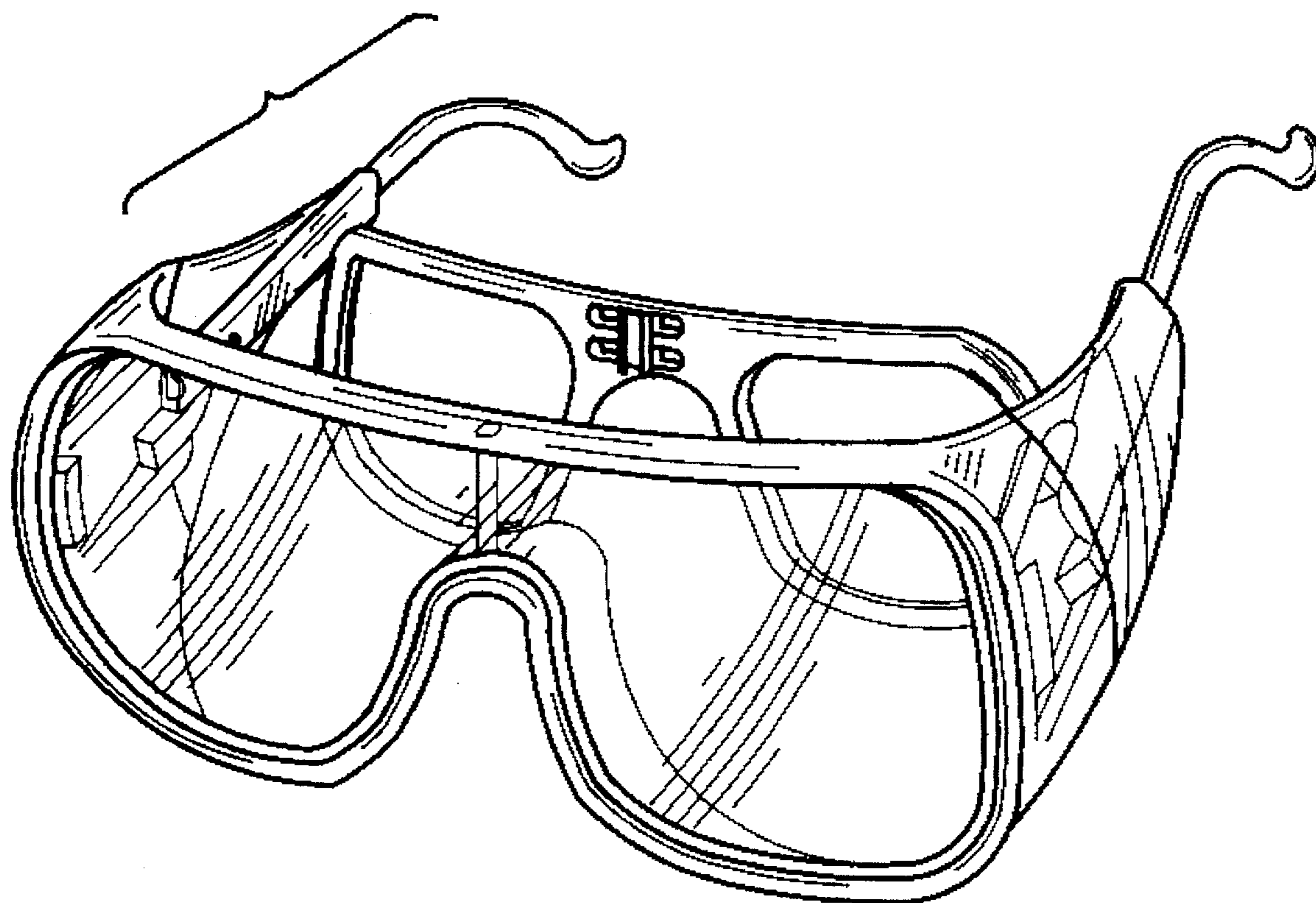

FIG. 6