



US00D372469S

United States Patent [19]

Samborsky

[11] Patent Number: **Des. 372,469**

[45] Date of Patent: ****Aug. 6, 1996**

[54] **BASKETBALL MOTIF COMPUTER DUST COVER KIT**

[76] Inventor: **Virgil L. Samborsky**, 5202 Hahn Ave., Fairborn, Ohio 45324

[**] Term: **14 Years**

[21] Appl. No.: **39,060**

[22] Filed: **May 19, 1995**

[52] U.S. Cl. **D14/114**

[58] **Field of Search** D14/114; D2/615; D3/274; D6/610; D9/165, 307, 417; D21/2, 7, 11, 14, 204, 201; 150/154, 158, 164, 165; 181/200, 201; 206/315.1, 315.4, 320, 586; 312/208.3

[56] **References Cited**

U.S. PATENT DOCUMENTS

D. 264,230	5/1982	Hanzawa	D21/13
D. 265,561	7/1982	Cottrell	D14/114
D. 291,203	8/1987	Silver	D14/114
D. 319,218	8/1991	Sakaguchi et al.	D14/100
D. 323,929	2/1992	Hodson	D3/30.1
D. 349,893	8/1994	Bennett	D14/114
D. 361,558	8/1995	Siano, Jr.	D14/114
D. 361,559	8/1995	Siano, Jr.	D14/114

D. 365,862	1/1996	Shishido et al.	D21/204
2,492,262	12/1949	Boyden et al.	312/208.3 X
4,922,980	5/1990	Parker	150/165

OTHER PUBLICATIONS

MacWarehouse Mar. 1992 p. 69 *Basic Needs Nylon Dust Covers.*

Primary Examiner—Freda Nunn
Attorney, Agent, or Firm—Biebel & French

[57] **CLAIM**

The ornamental design for a basketball motif computer dust cover kit, as shown and described.

DESCRIPTION

FIG. 1 is a perspective view of a basketball motif computer dust cover kit in accordance with my invention;
FIG. 2 is a top view thereof;
FIG. 3 is a front view thereof;
FIG. 4 is a back view thereof;
FIG. 5 is a left-hand side view thereof;
FIG. 6 is a right-hand side view thereof; and,
FIG. 7 is a bottom view thereof.
The broken lines are shown in the figures for illustrative purposes only and form no part of the claimed design.

1 Claim, 3 Drawing Sheets

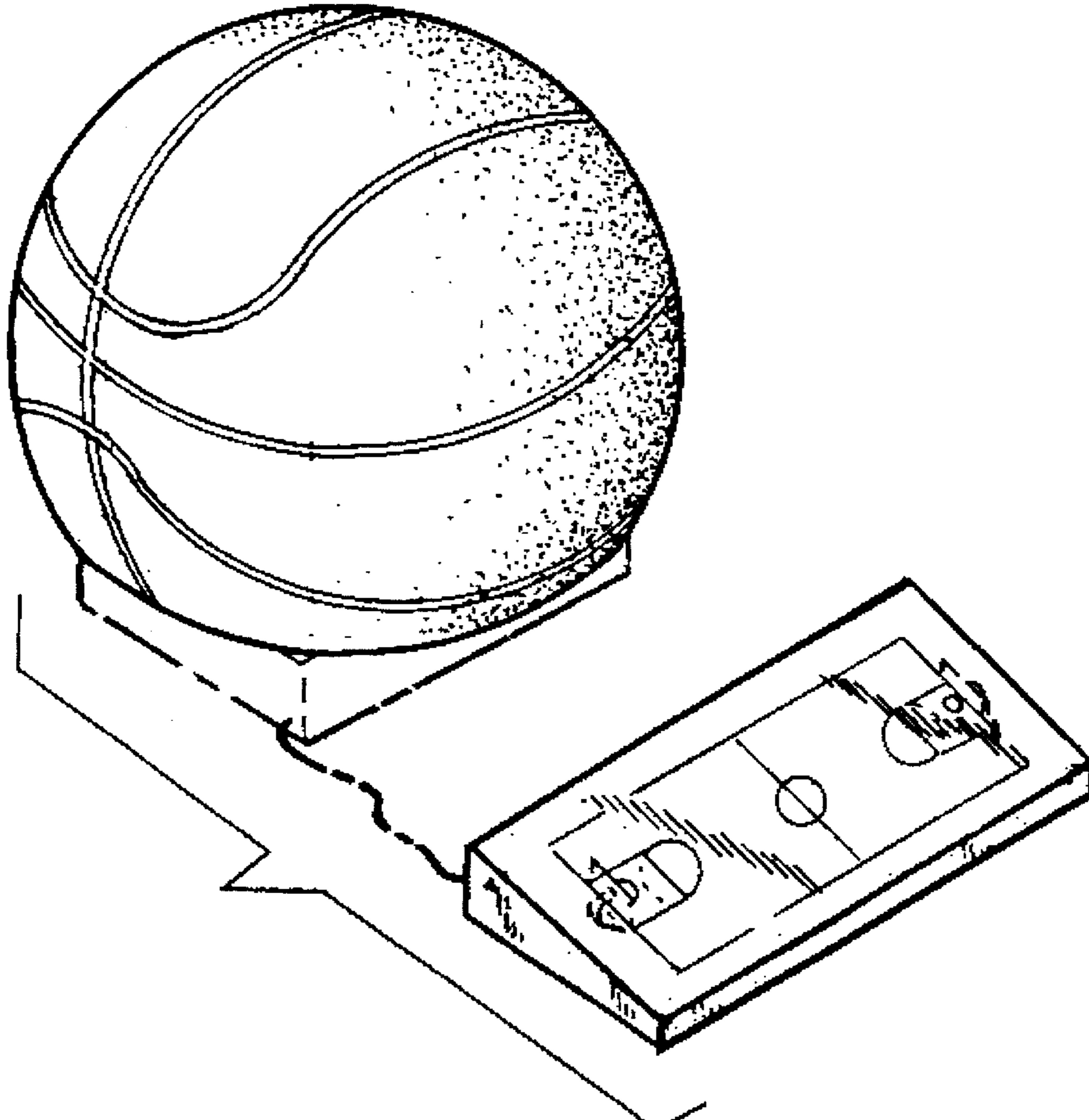

FIG-1

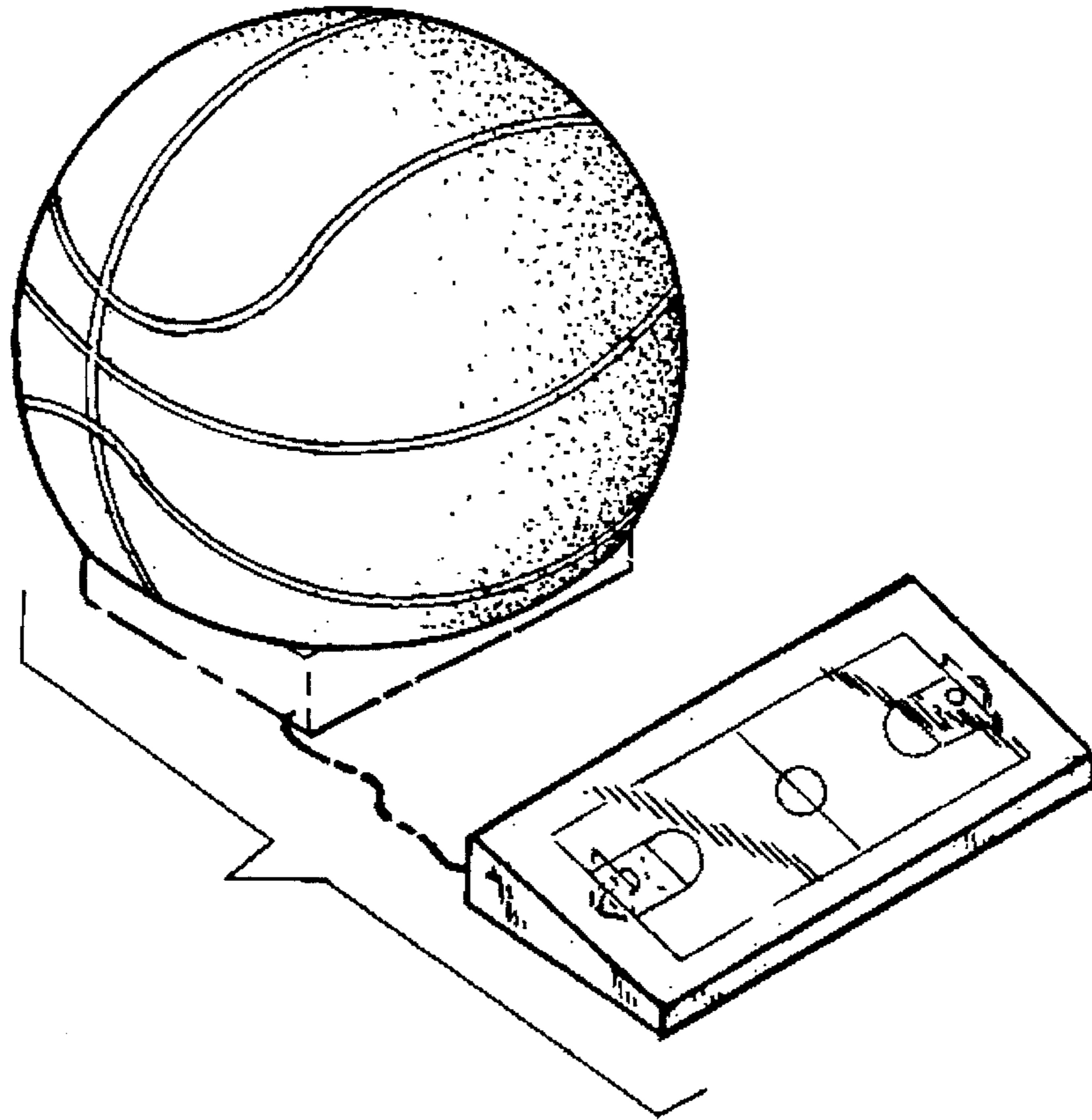

FIG-2

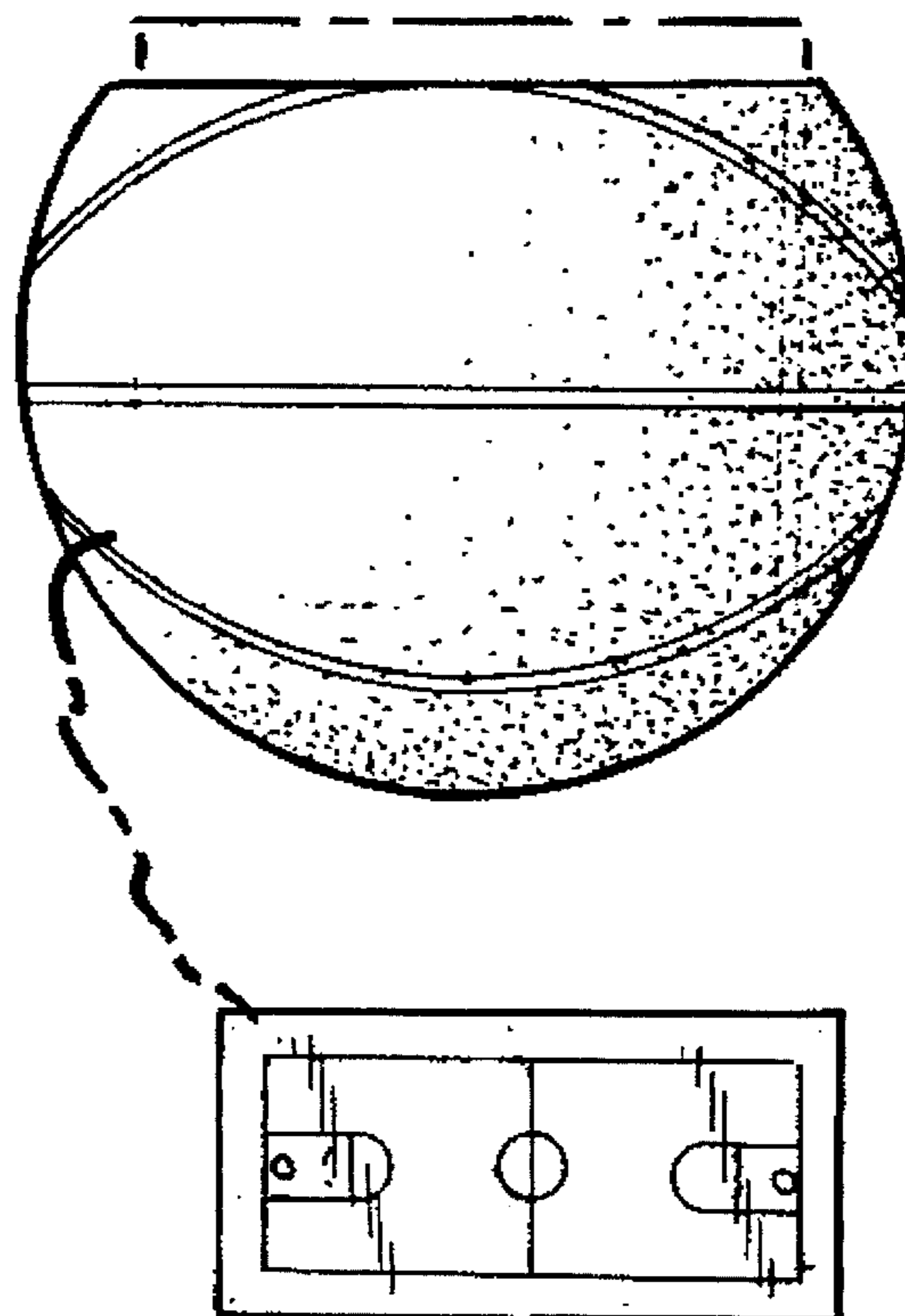

FIG -3

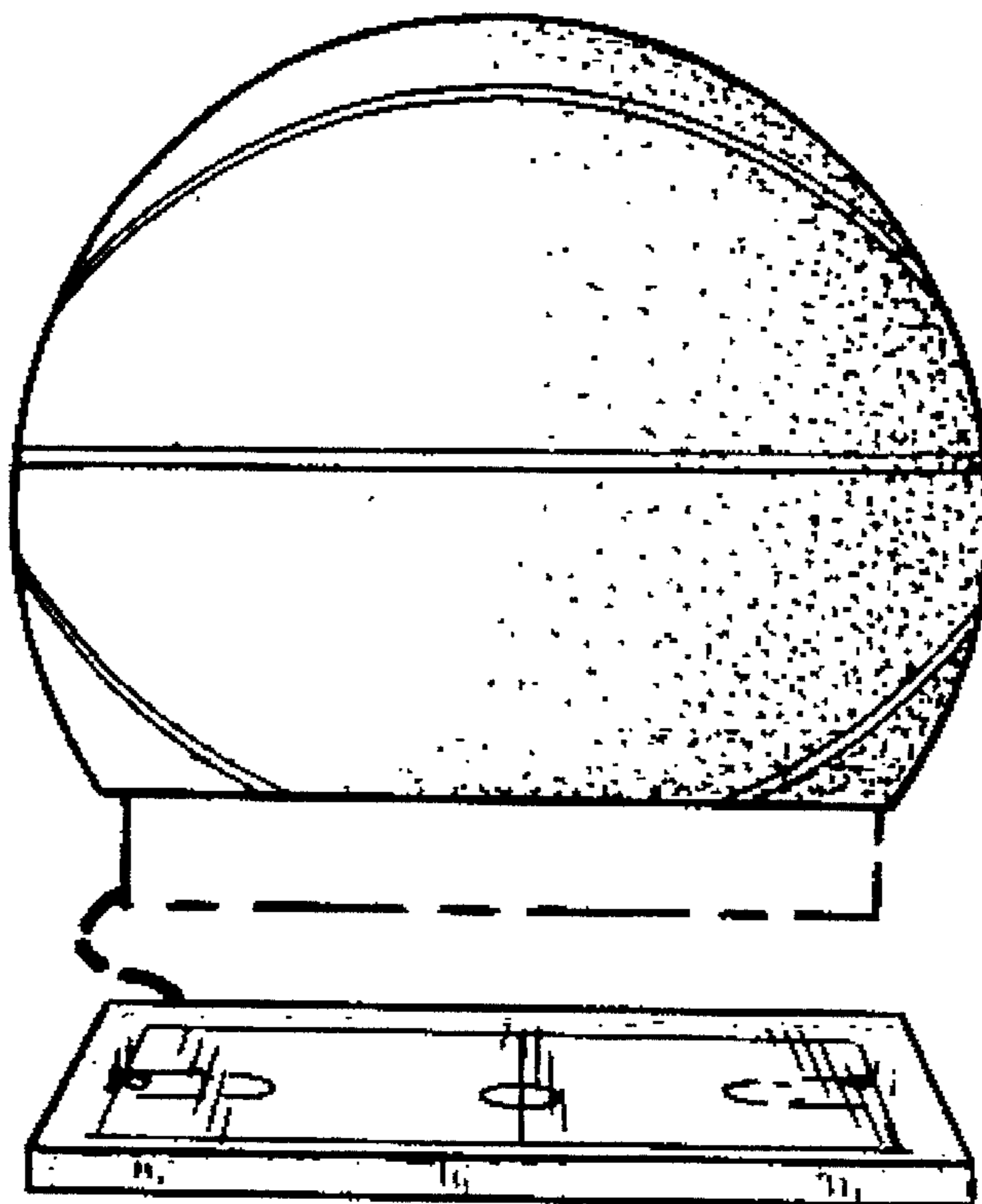

FIG -4

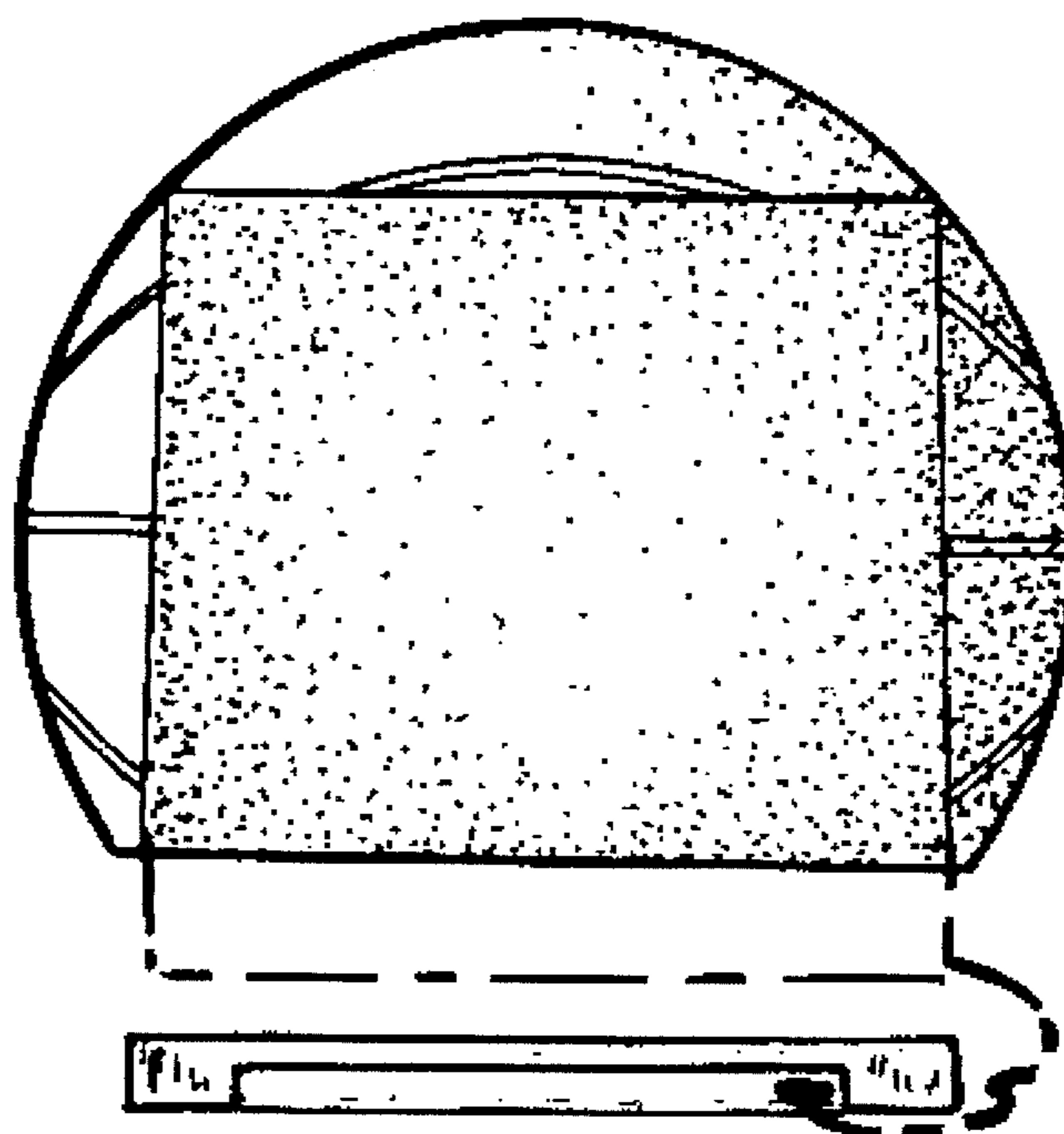

FIG - 5

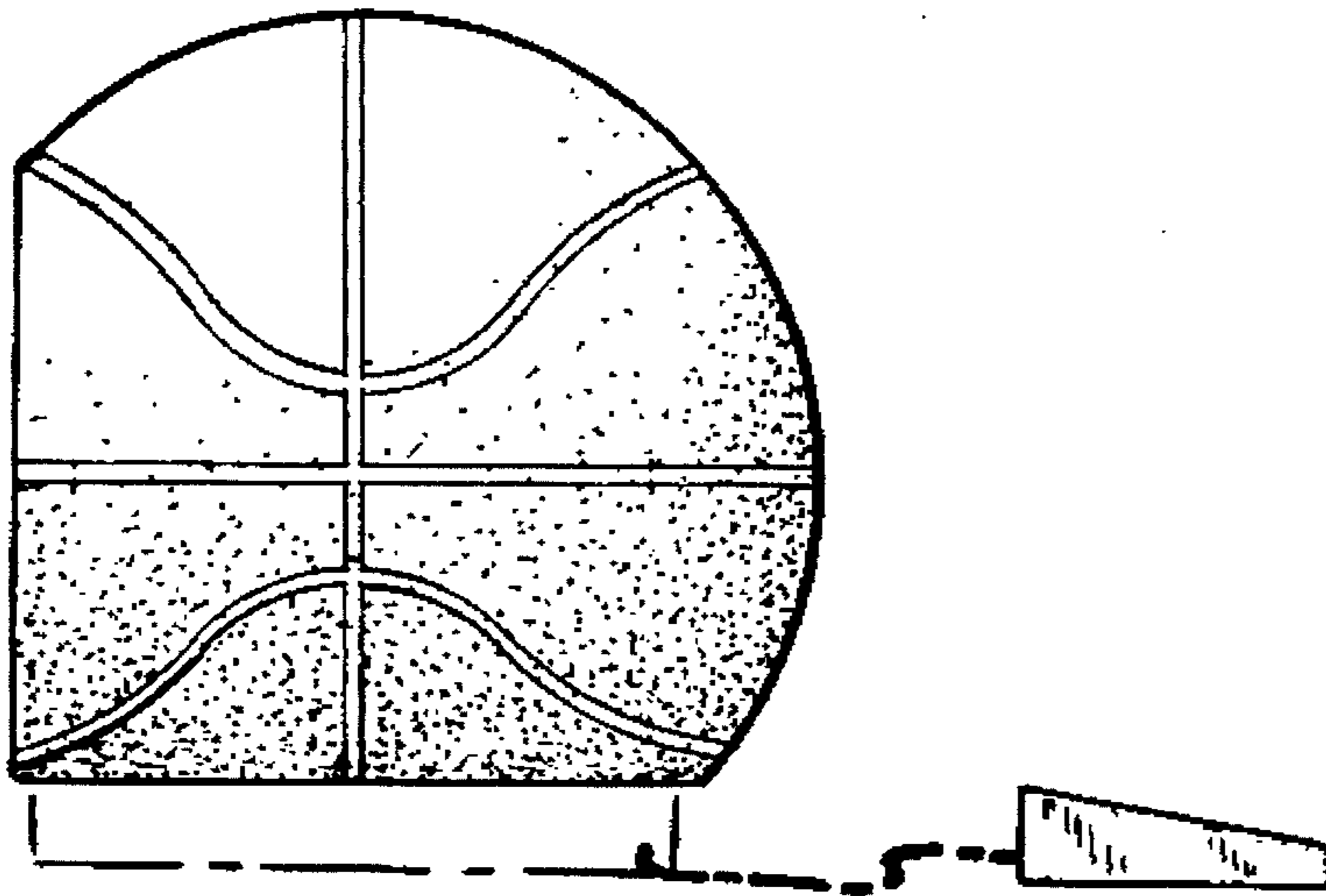

FIG - 6

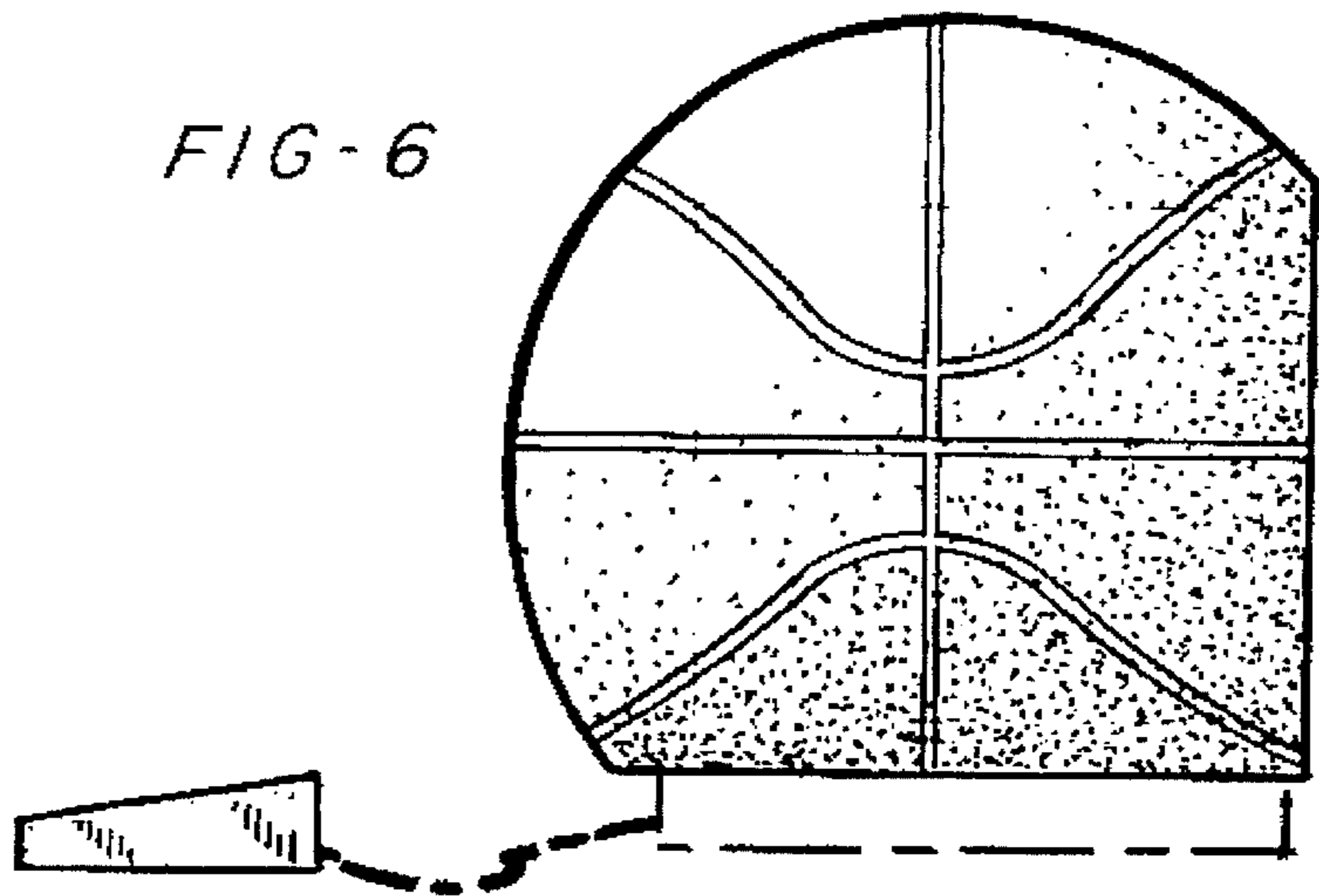

FIG - 7

