



US00D372466S

United States Patent [19] Chu

[11] Patent Number: Des. 372,466

[45] Date of Patent: **Aug. 6, 1996

[54] NOTEBOOK PERSONAL COMPUTER

[75] Inventor: **Chi-Tsong Chu**, Taipei, Taiwan

[73] Assignee: **Compaq Computer Corporation**,
Houston, Tex.

[**] Term: **14 Years**

[21] Appl. No.: **43,133**

[22] Filed: **Aug. 22, 1995**

[52] U.S. Cl. **D14/106**

[58] Field of Search D14/100, 101,
D14/106, 113, 115, 124-127; D18/1, 2,
7; 235/145 A, 145 R; 341/22, 23; 345/104,
156, 168, 173, 901-905, 87; 361/679-686;
364/708.1, 709.04, 709.12; 400/486, 489

[56] References Cited

U.S. PATENT DOCUMENTS

D. 346,368	4/1994	Miyashita et al.	D14/106
D. 350,121	8/1994	Kaneko	D14/106
D. 356,072	3/1995	Mundt	D14/106

OTHER PUBLICATIONS

PC Computing Jun. 1994 p. 302 *Portable Computer*.

Primary Examiner—Freda Nunn

Attorney, Agent, or Firm—L. J. Lindsay

[57] CLAIM

The ornamental design for a notebook personal computer, as shown and described.

DESCRIPTION

FIG. 1 is a front, right side, top perspective view of a notebook personal computer showing a first embodiment of my new design;

FIG. 2 is a front elevational view thereof;

FIG. 3 is a left side elevational view thereof;

FIG. 4 is a right side elevational view thereof;

FIG. 5 is a top plan view thereof;

FIG. 6 is a bottom plan view thereof;

FIG. 7 is a rear elevational view thereof;

FIG. 8 is a front right side and top perspective view thereof shown in an open position;

FIG. 9 is a front elevational view thereof;

FIG. 10 is a top plan view thereof;

FIG. 11 is a left side elevational view thereof;

FIG. 12 is a right side elevational view thereof;

FIG. 13 is a bottom plan view thereof; and,

FIG. 14 is a rear elevational view thereof.

1 Claim, 5 Drawing Sheets

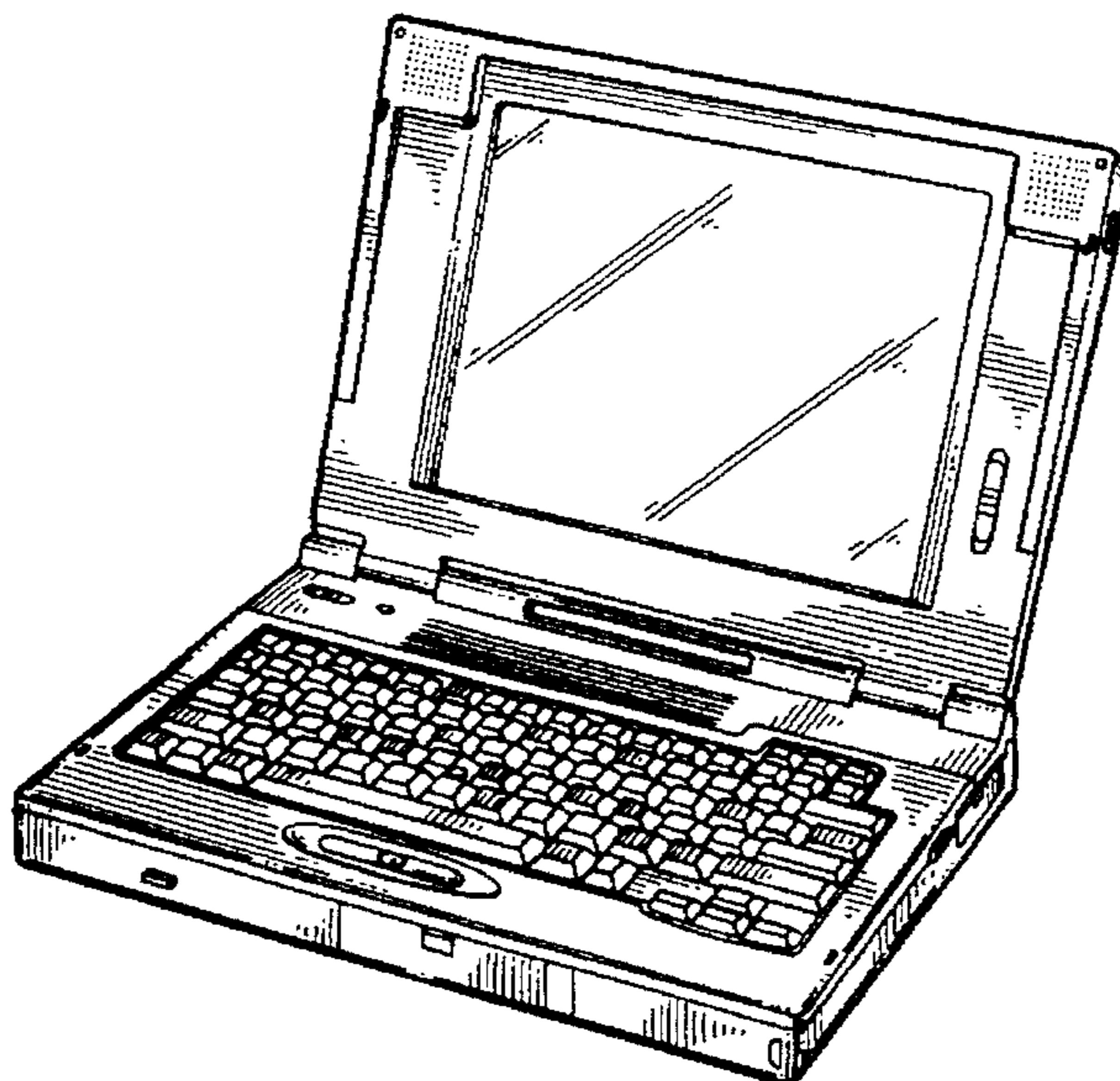
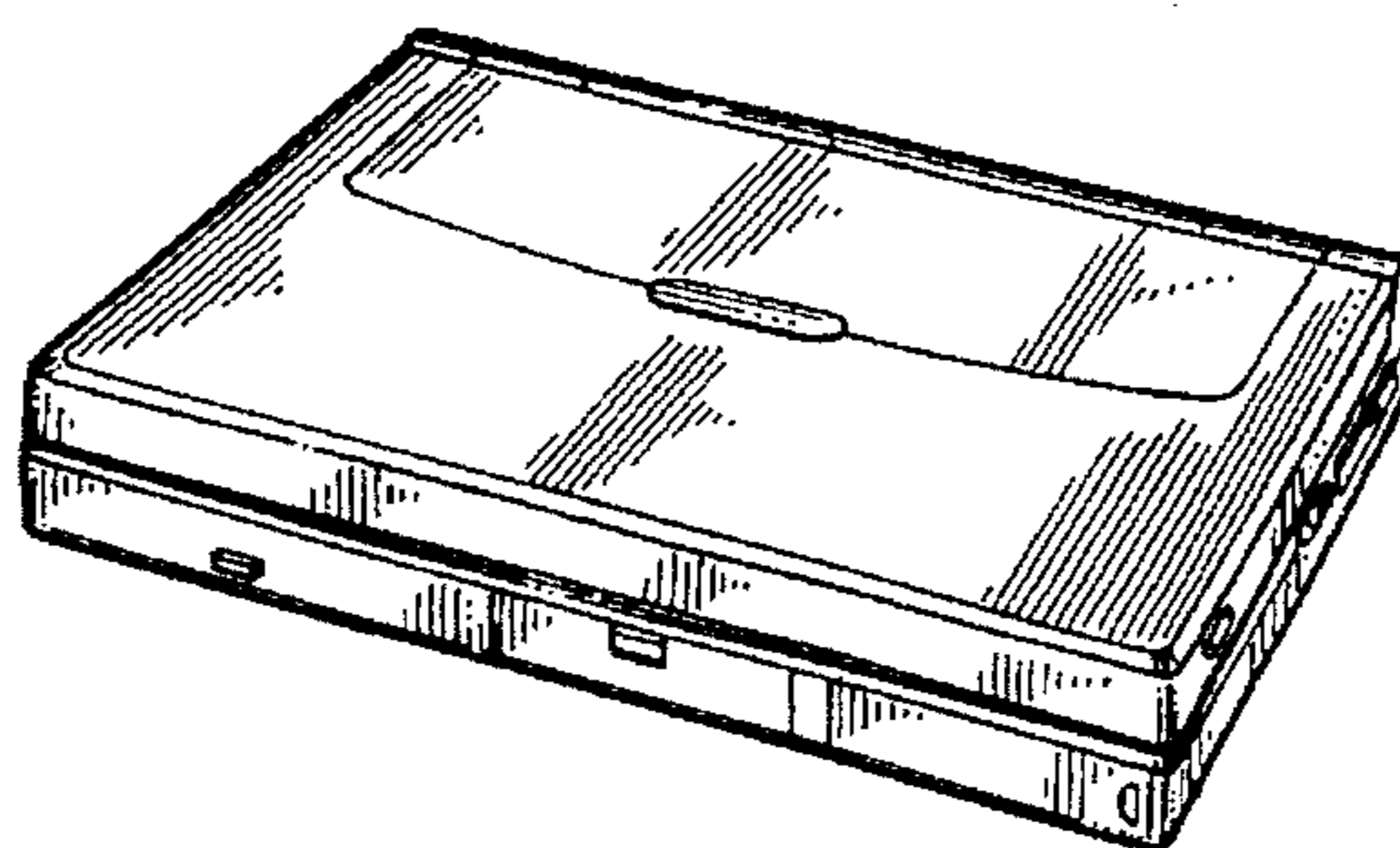

FIG. 1

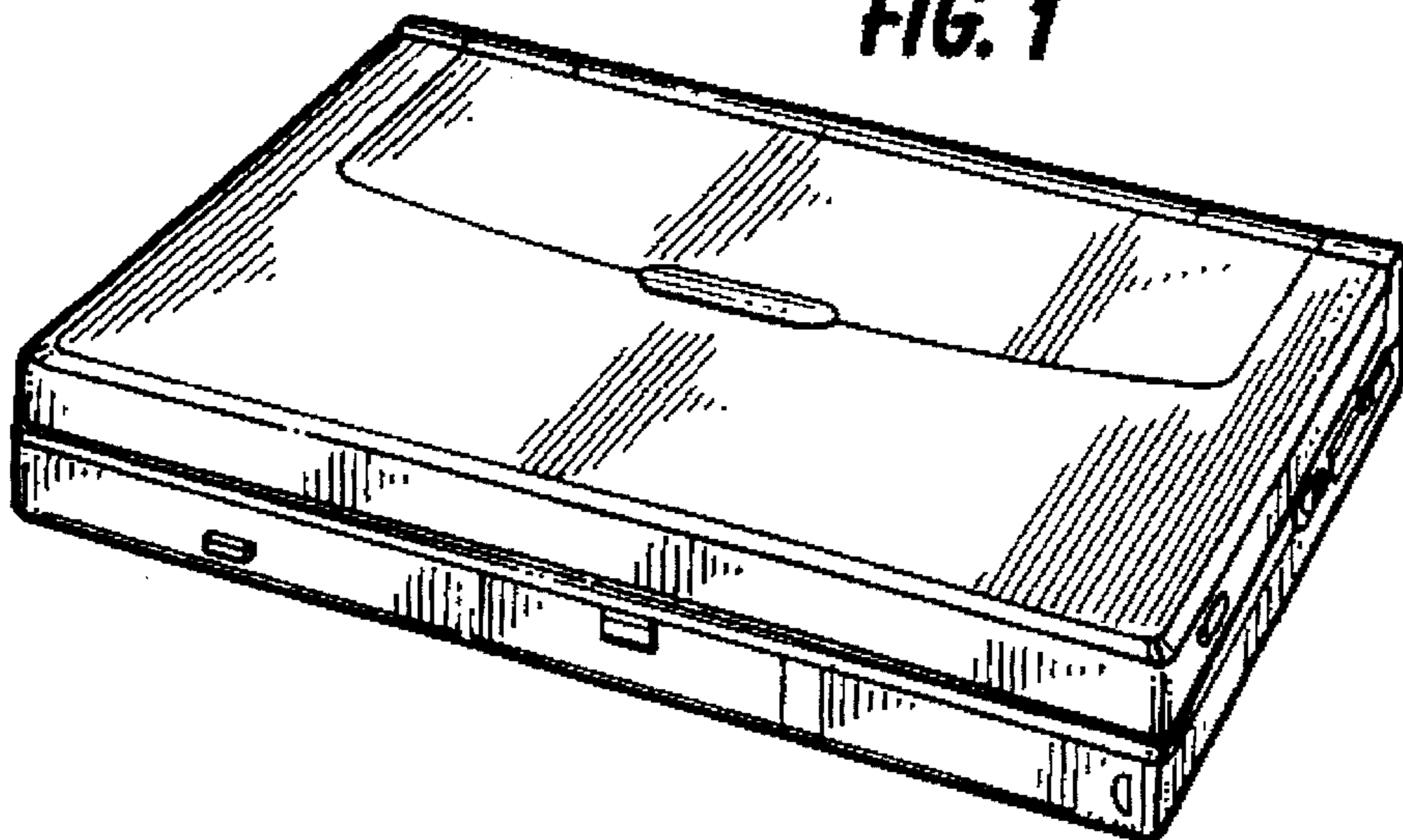

FIG. 2

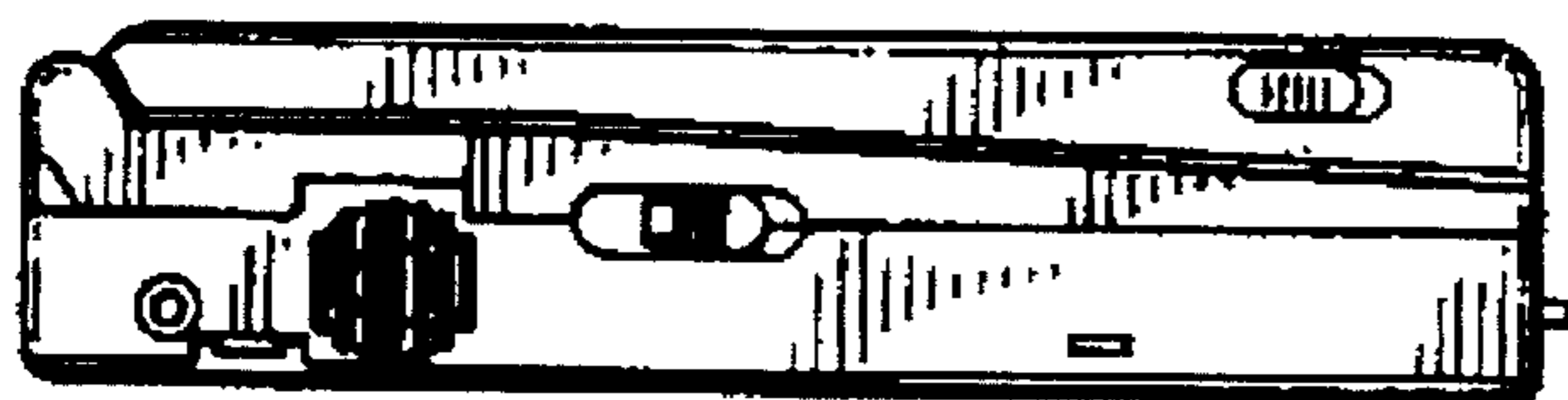
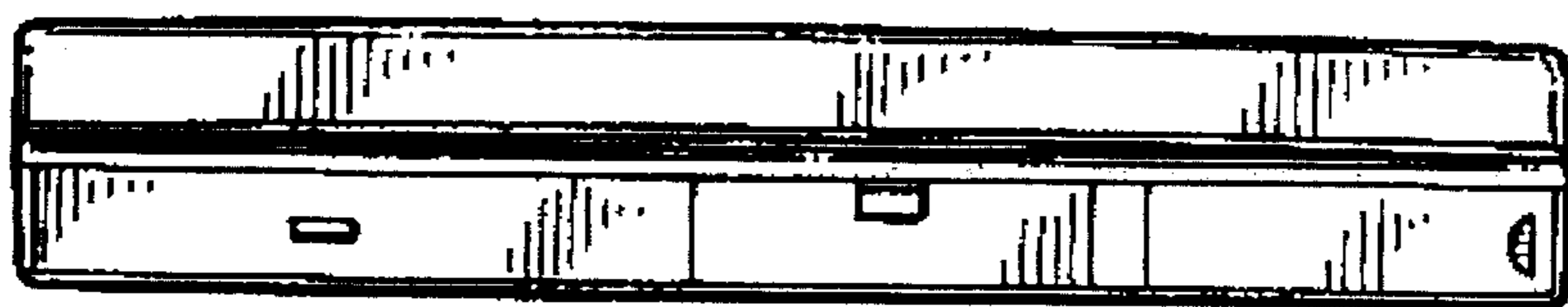

FIG. 3

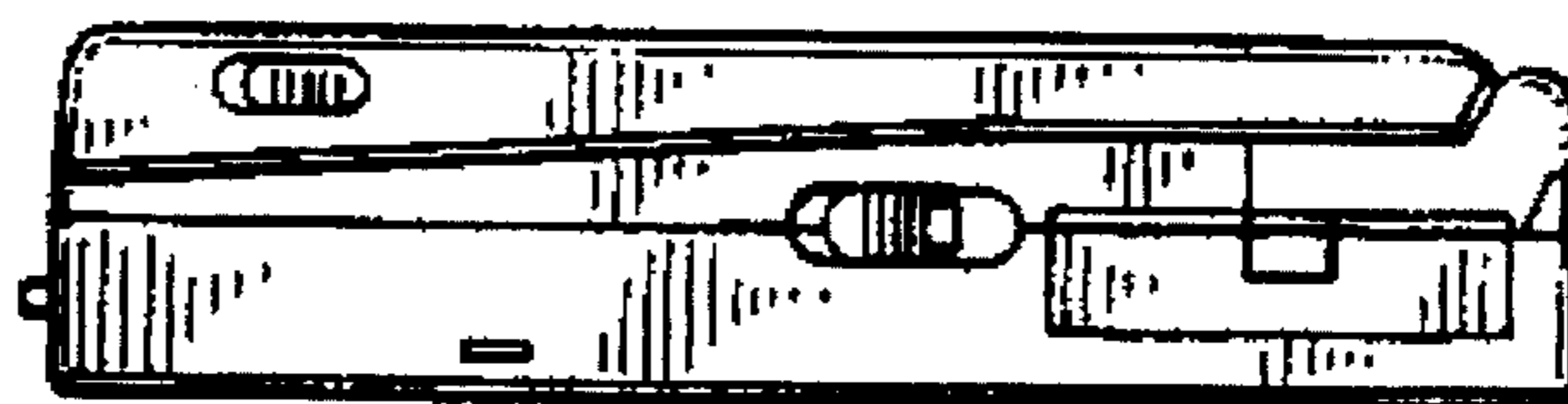

FIG. 4

FIG. 5

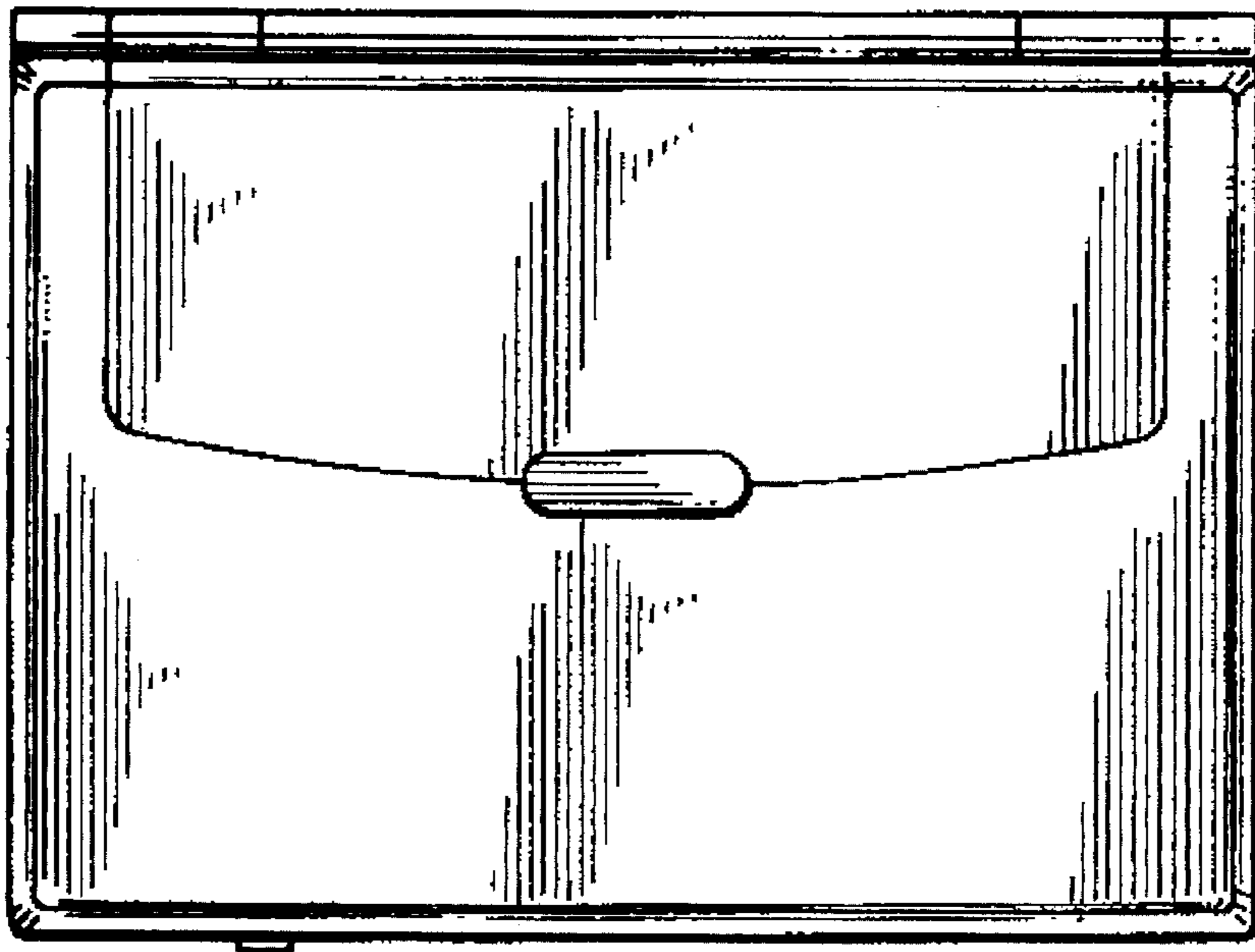

FIG. 6

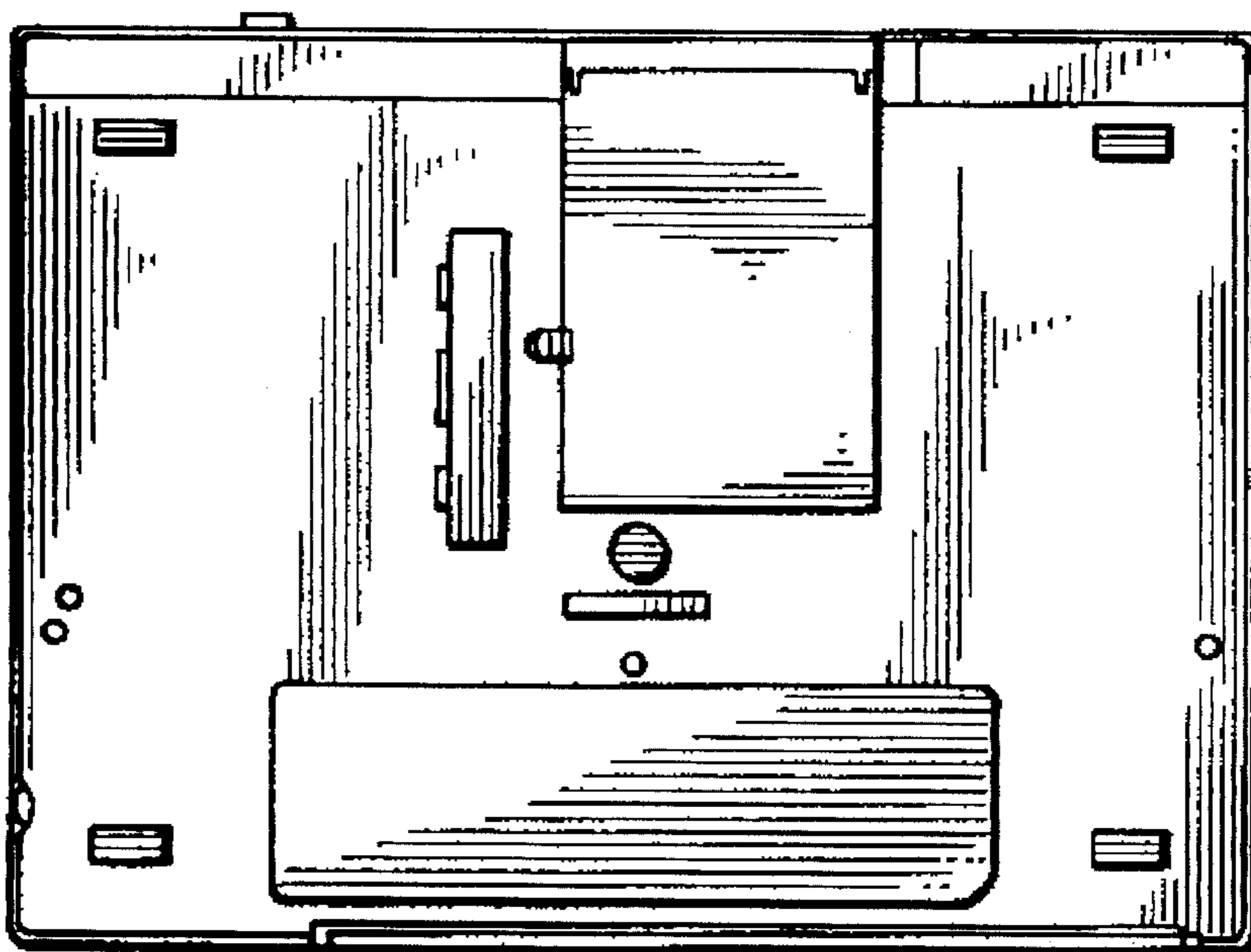
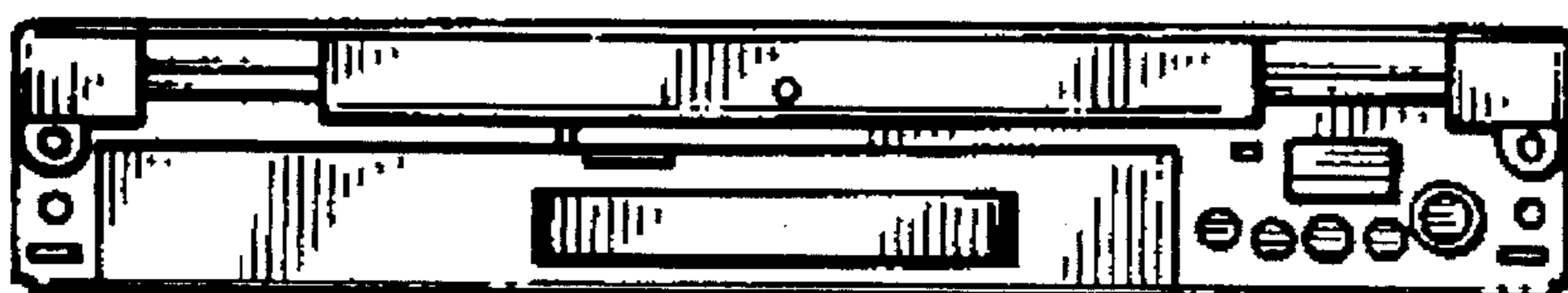

FIG. 7



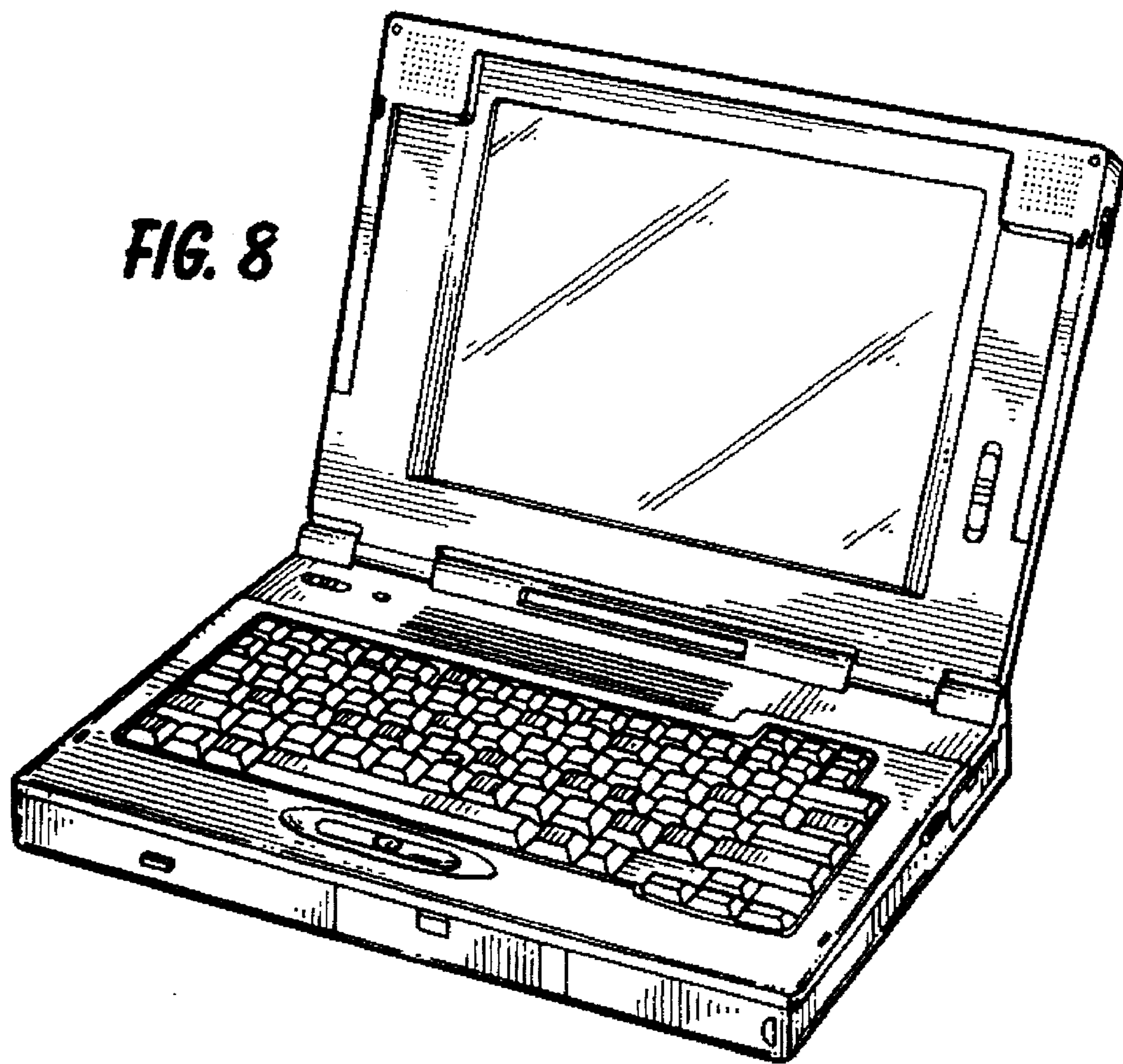

FIG. 8

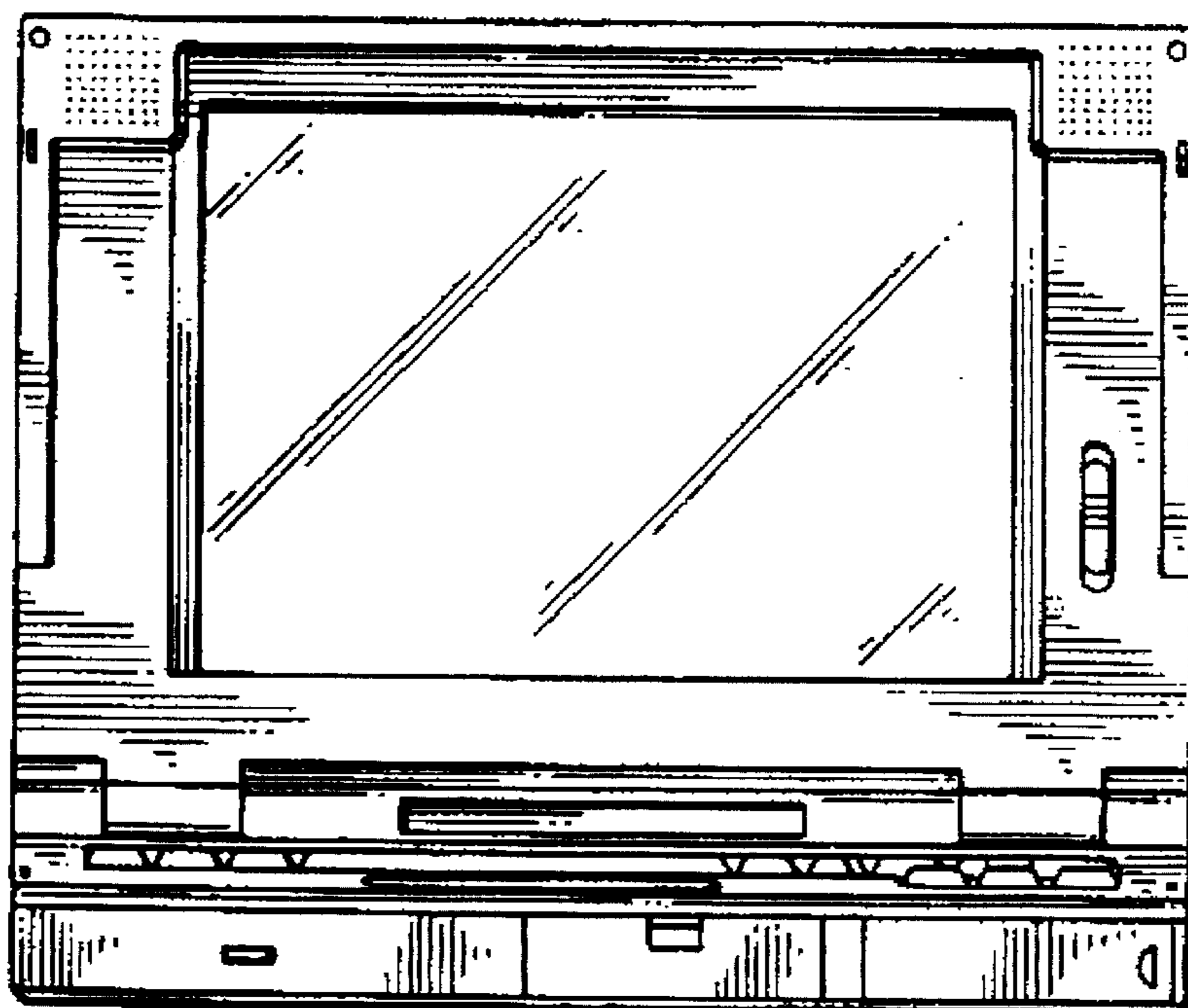

FIG. 9

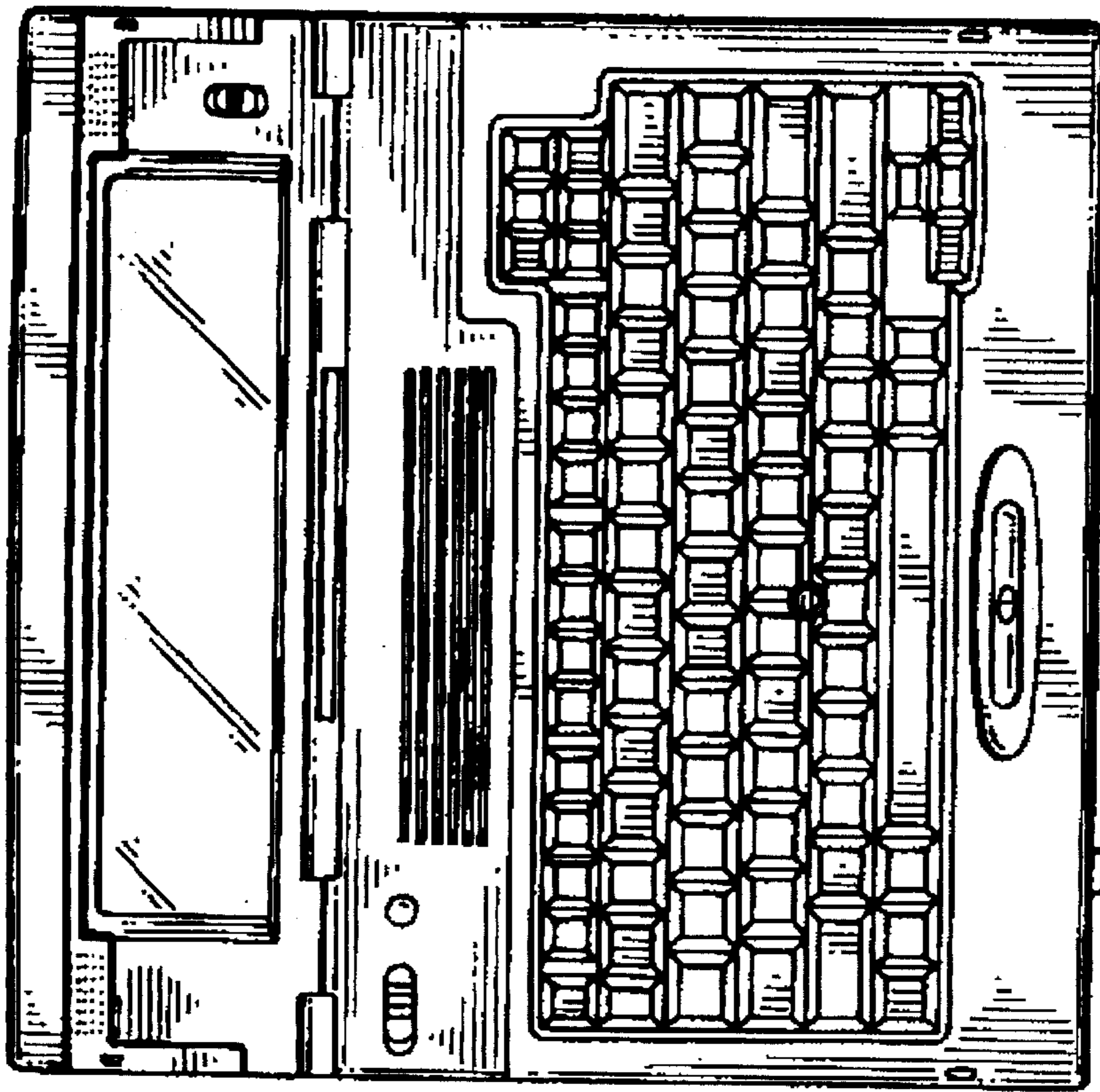

FIG. 10

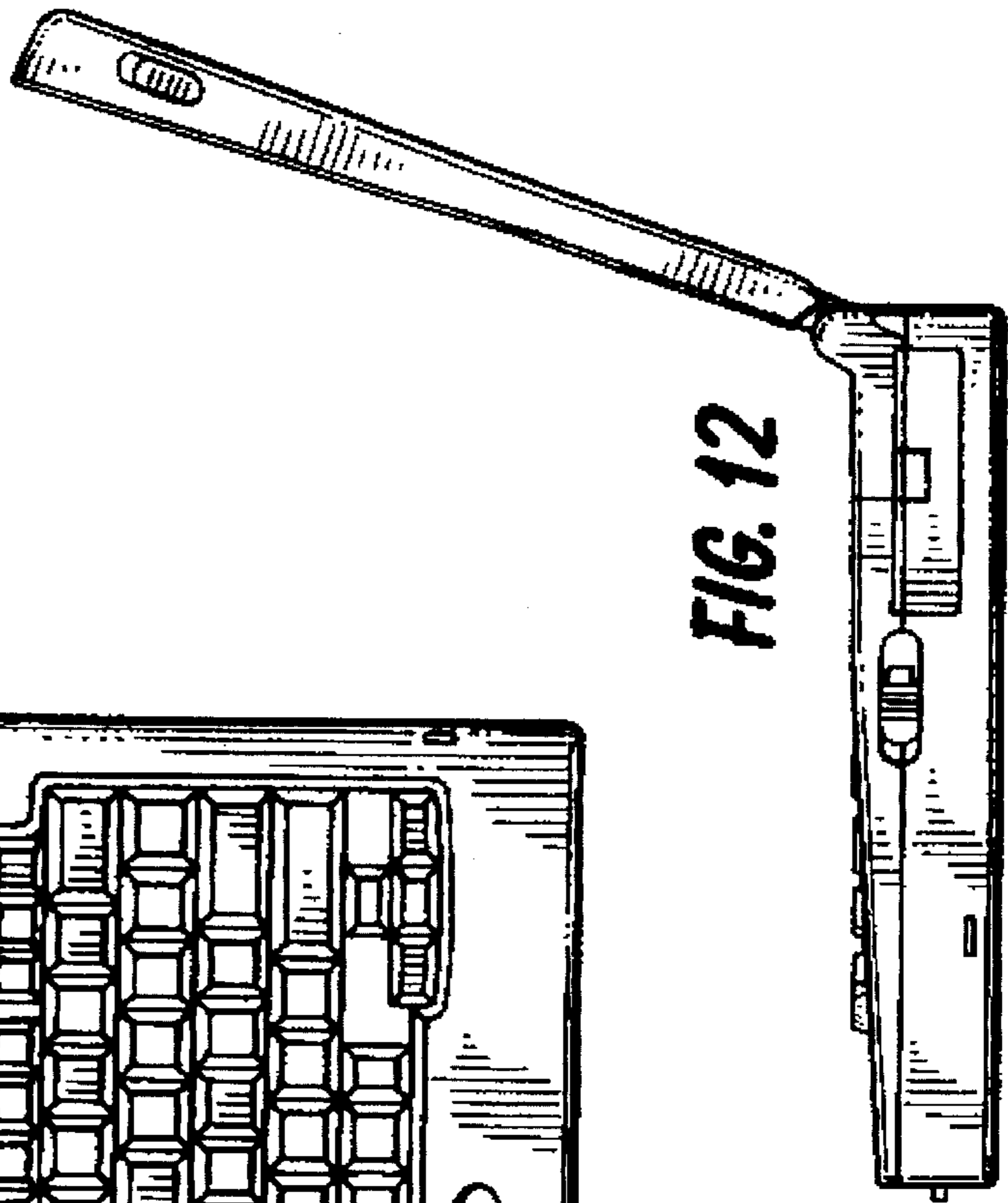

FIG. 12

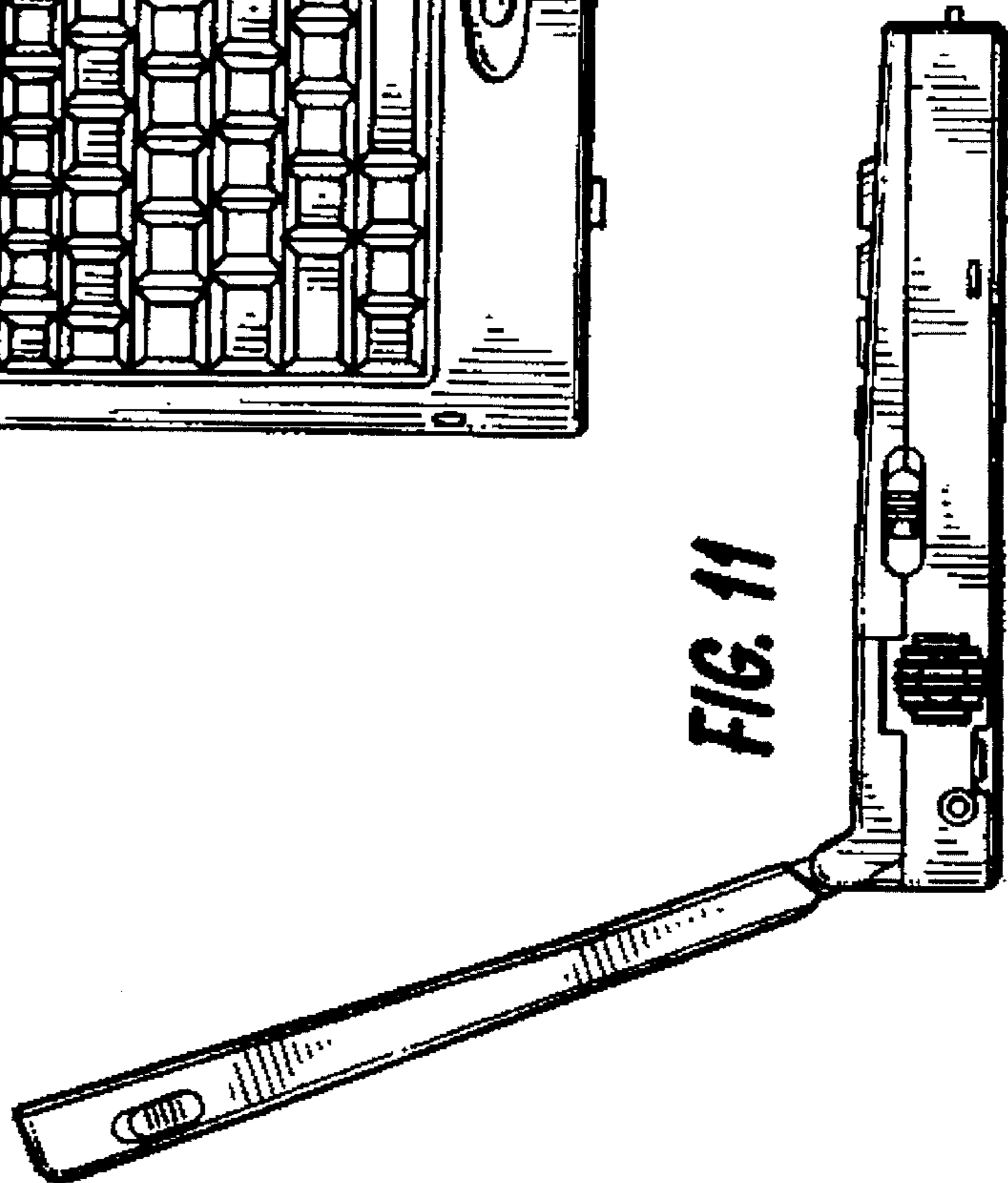

FIG. 11

FIG. 14

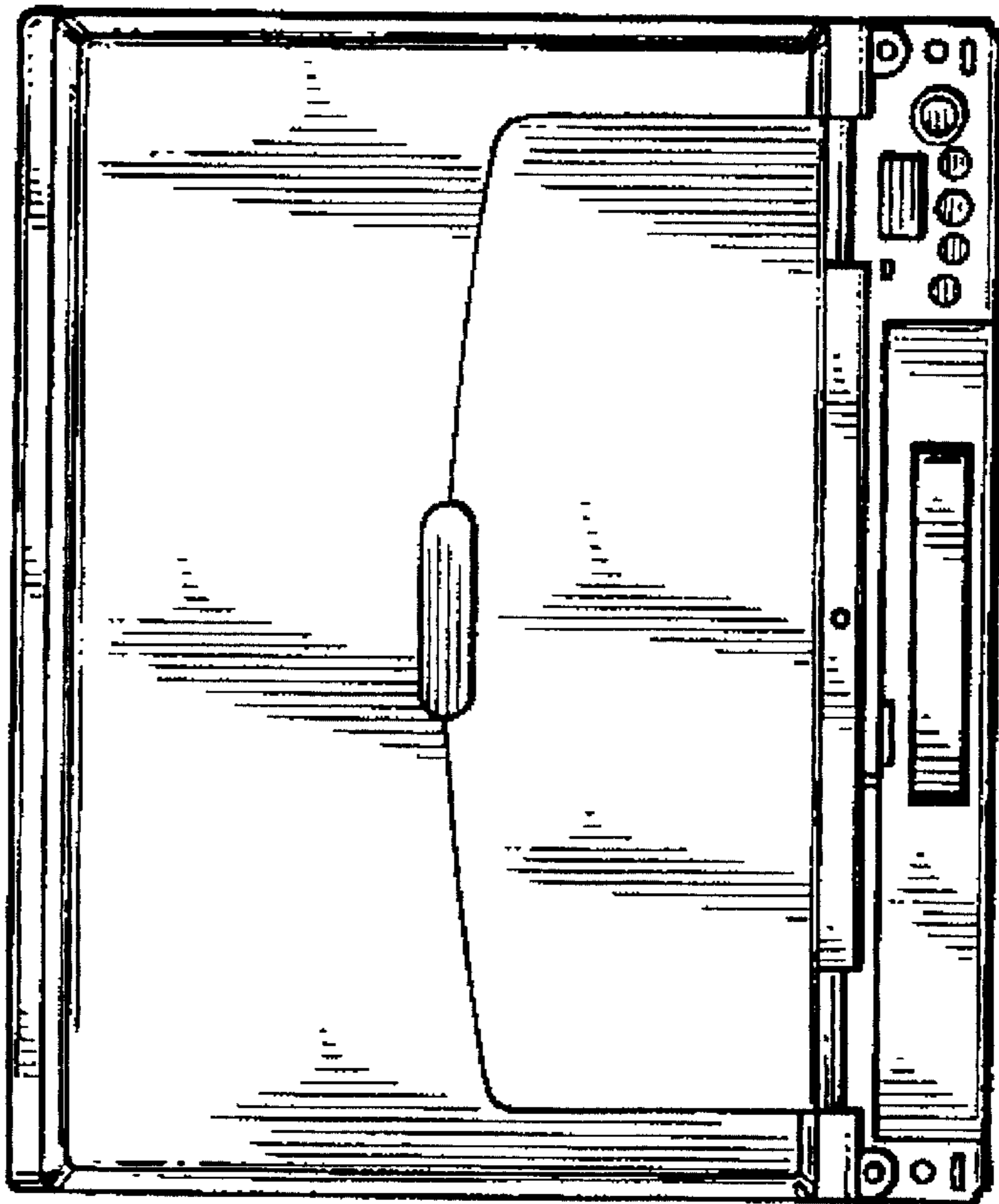

FIG. 13

