



US00D372384S

# United States Patent [19]

[11] Patent Number: **Des. 372,384**

**Saldana et al.**

[45] Date of Patent: **\*\*\* Aug. 6, 1996**

[54] **TABLE**

- [75] Inventors: **Leonard R. Saldana**, Hendersonville, Tenn.; **Joseph E. Blazar**, Joplin, Mo.
- [73] Assignee: **Sunbeam Products, Inc.**, Fort Lauderdale, Fla.
- [\*] Notice: The portion of the term of this patent subsequent to Aug. 6, 2010, has been disclaimed.
- [\*\*] Term: **14 Years**
- [21] Appl. No.: **20,796**
- [22] Filed: **Apr. 1, 1994**
- [52] U.S. Cl. .... **D6/487**
- [58] Field of Search ..... D6/480-489, 495-499; 108/153, 156, 157, 161; 248/188, 188.1

[56] **References Cited**

**U.S. PATENT DOCUMENTS**

D. 155,125	9/1949	Castelli .....	D6/488
D. 246,341	11/1977	Boughton .....	D6/487
D. 291,752	9/1987	Conn .....	D6/487
2,635,024	4/1953	Sanford .....	108/157

**FOREIGN PATENT DOCUMENTS**

219472	12/1910	Germany .....	108/153
830001	11/1957	United Kingdom .....	108/157

**OTHER PUBLICATIONS**

Floyd-Outdoor Line, #T6011 Table.

*Primary Examiner*—Janice E. Seeger

*Attorney, Agent, or Firm*—Paul D. Bangor, Jr.; Michael J. Kline; Carol I. Bordas

[57] **CLAIM**

The ornamental design for a table, as shown and described.

**DESCRIPTION**

FIG. 1 is a front perspective view of the table of the present invention having a table top comprising a transparent material;

FIG. 2 is a front elevational view of table of FIG. 1, which also illustrates the identical rear elevational view of the looped-leg elongated table of FIG. 1;

FIG. 3 is a top plan view of the table of FIG. 1;

FIG. 4 is a bottom plan view of the table of FIG. 1;

FIG. 5 is a left side elevational view of the table of FIG. 1 which also illustrates the identical right side elevational view of the looped-leg elongated table of FIG. 1; and,

FIG. 6 is a front perspective view of the table of the present invention having a table top comprising an opaque material. The characteristic feature of the design resides in the particular configuration of the tubular leg members as best shown in FIG. 2.

**1 Claim, 3 Drawing Sheets**

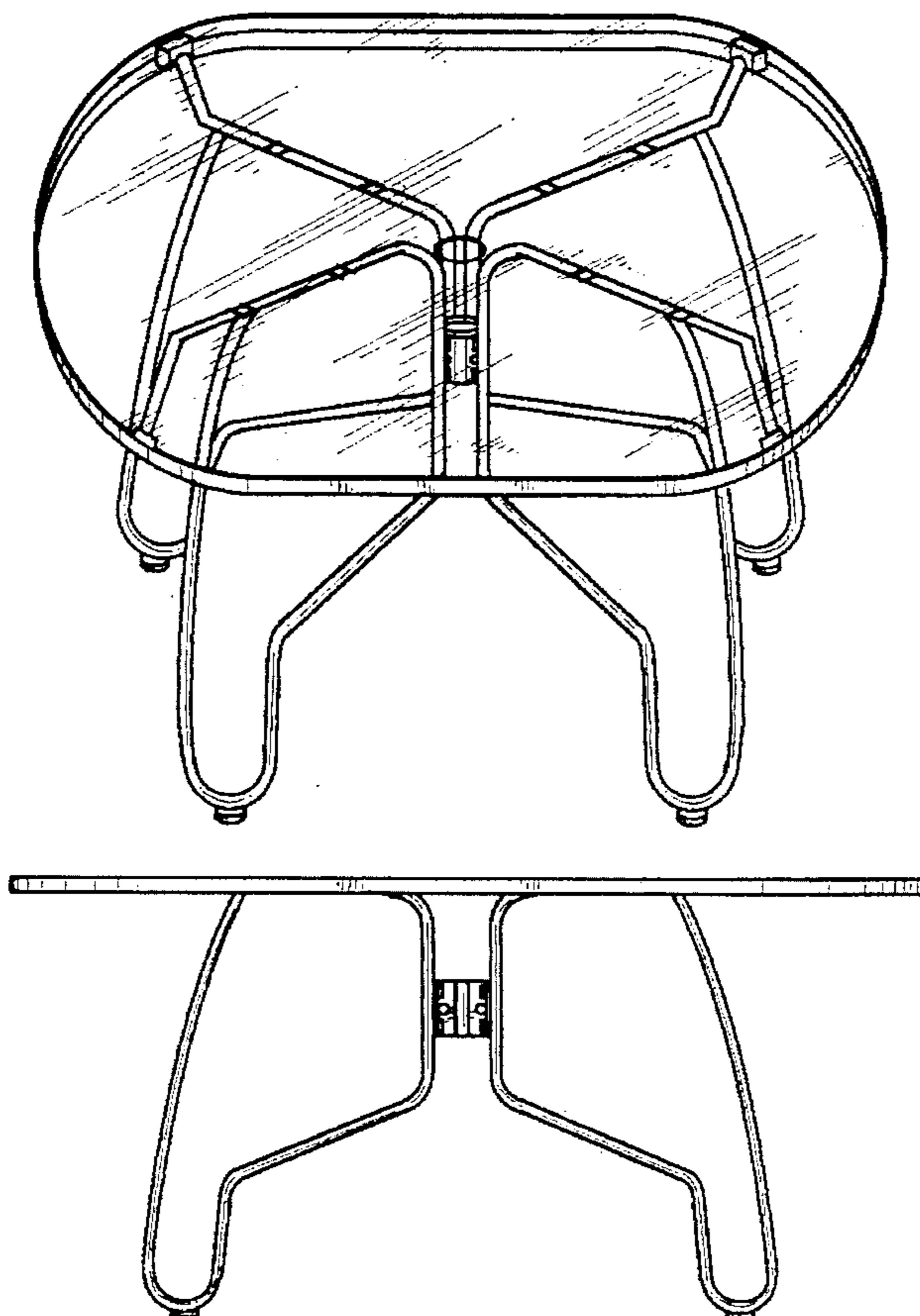

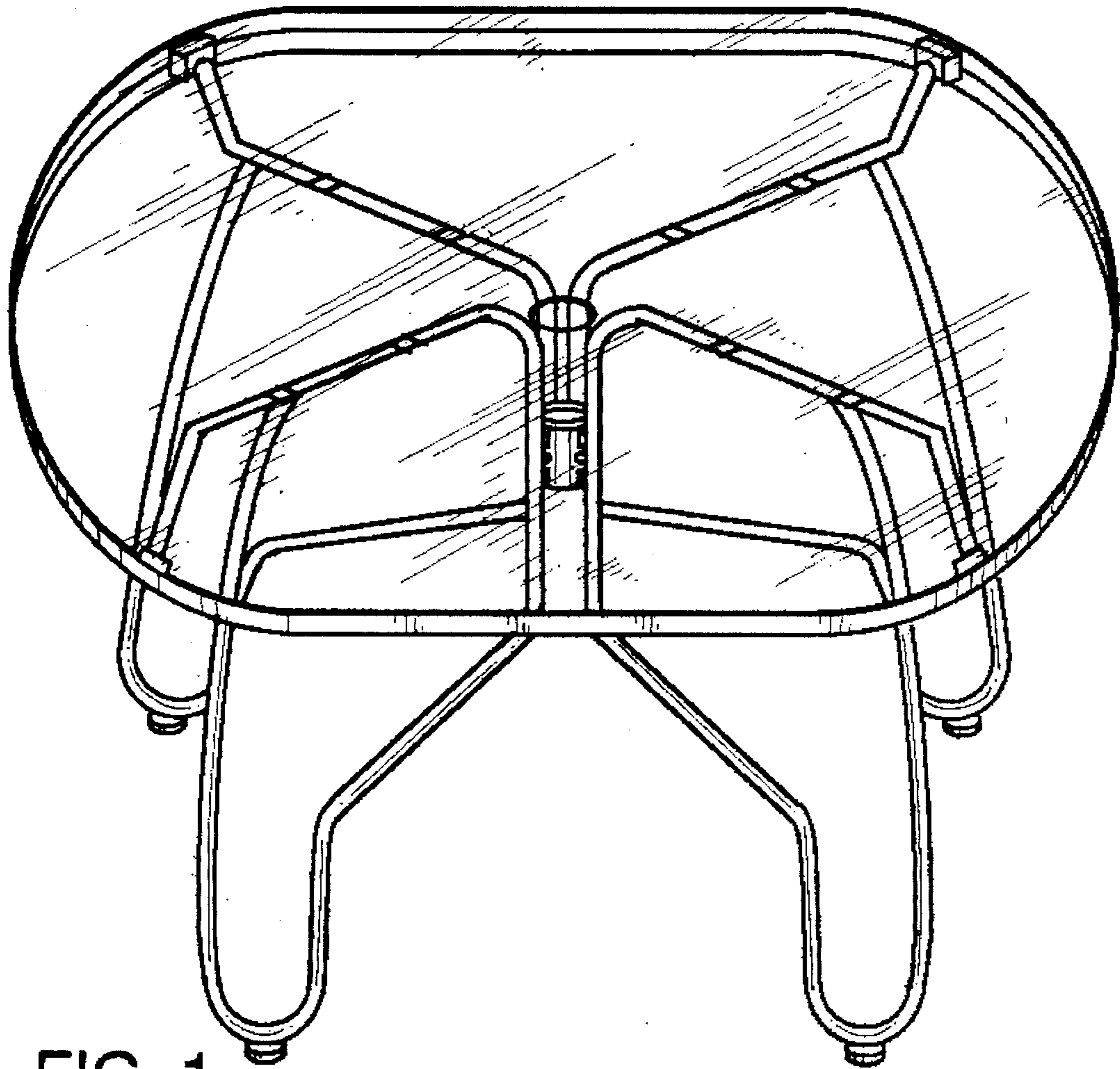

FIG. 1

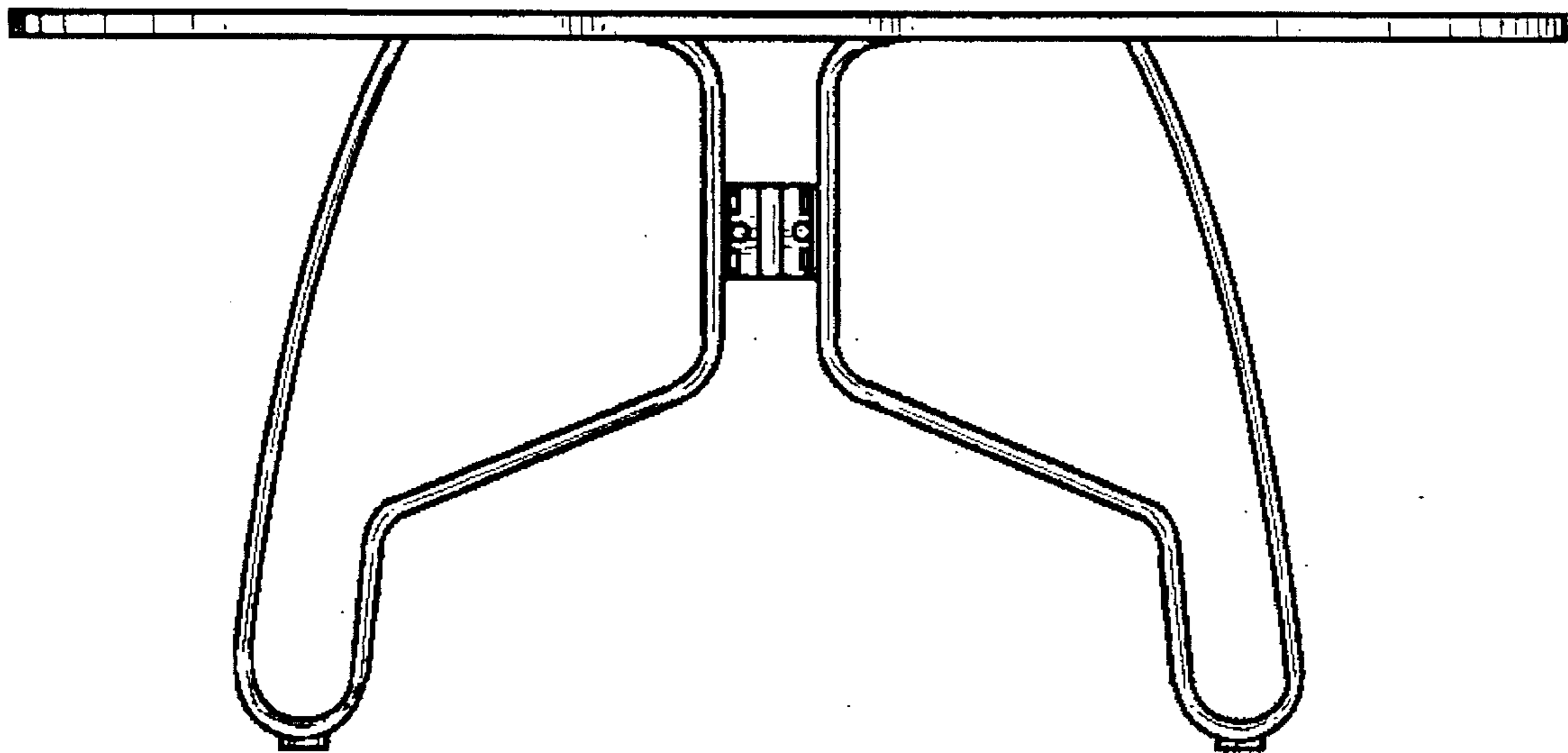

FIG. 2

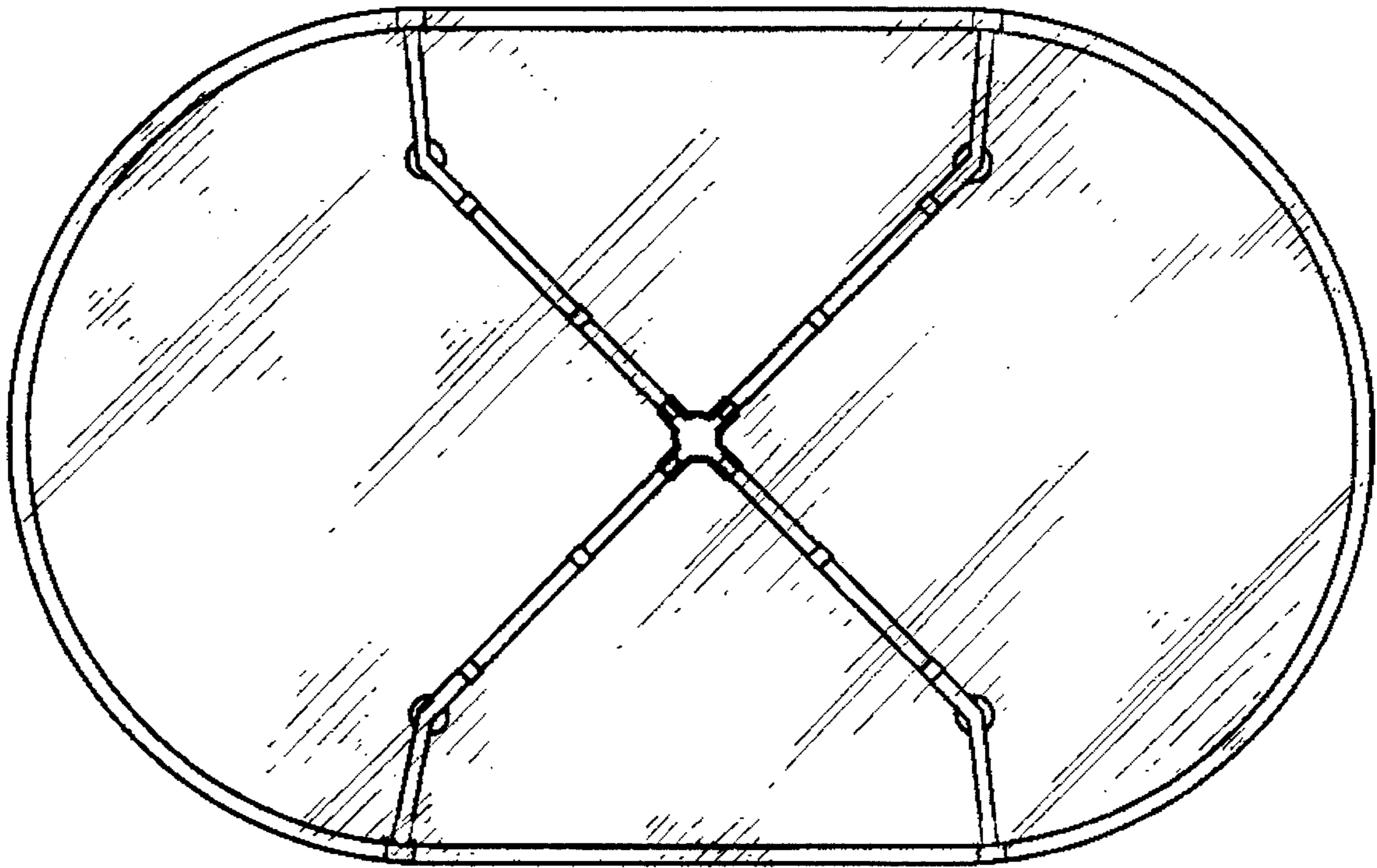

FIG. 3

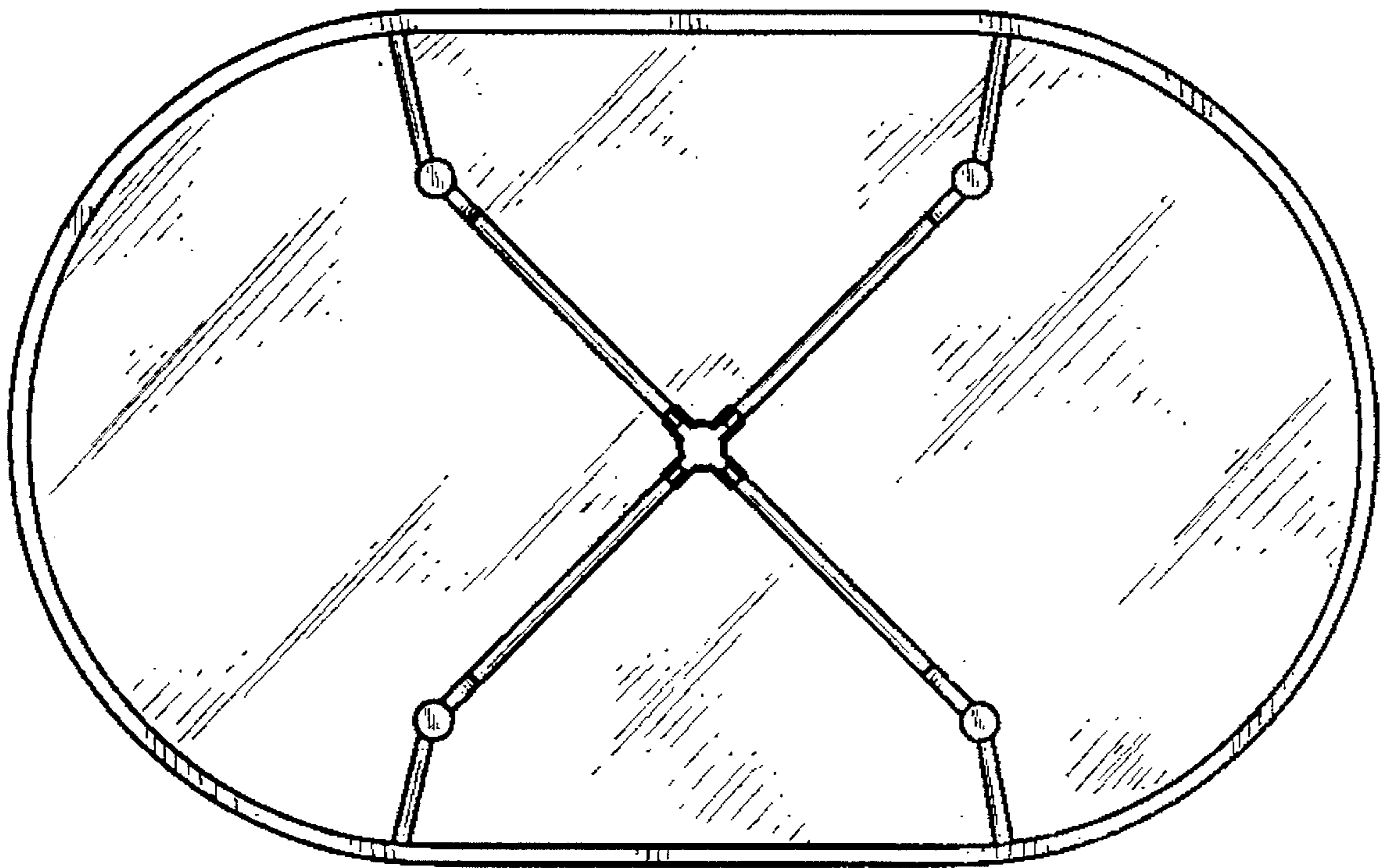

FIG. 4

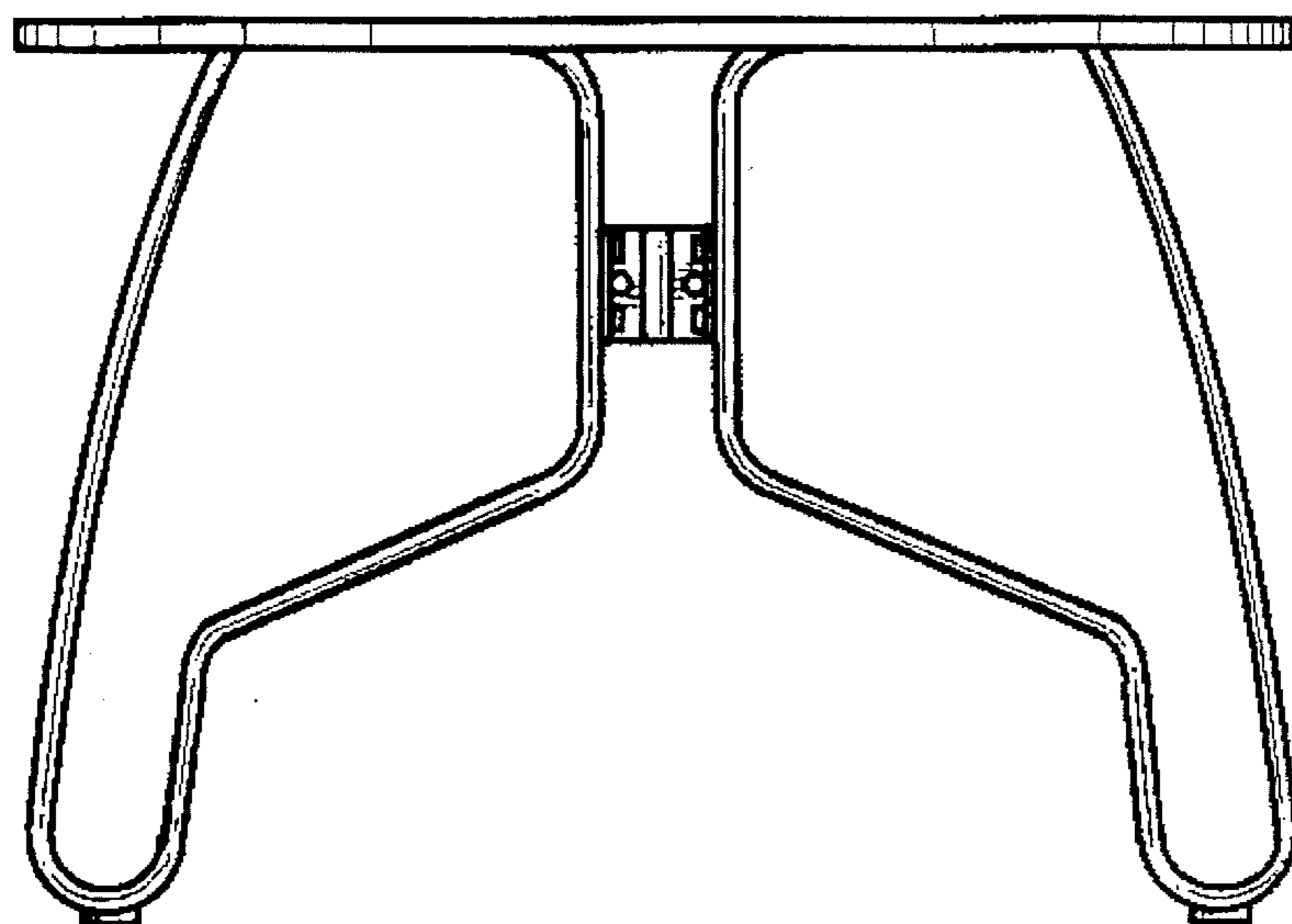

FIG. 5

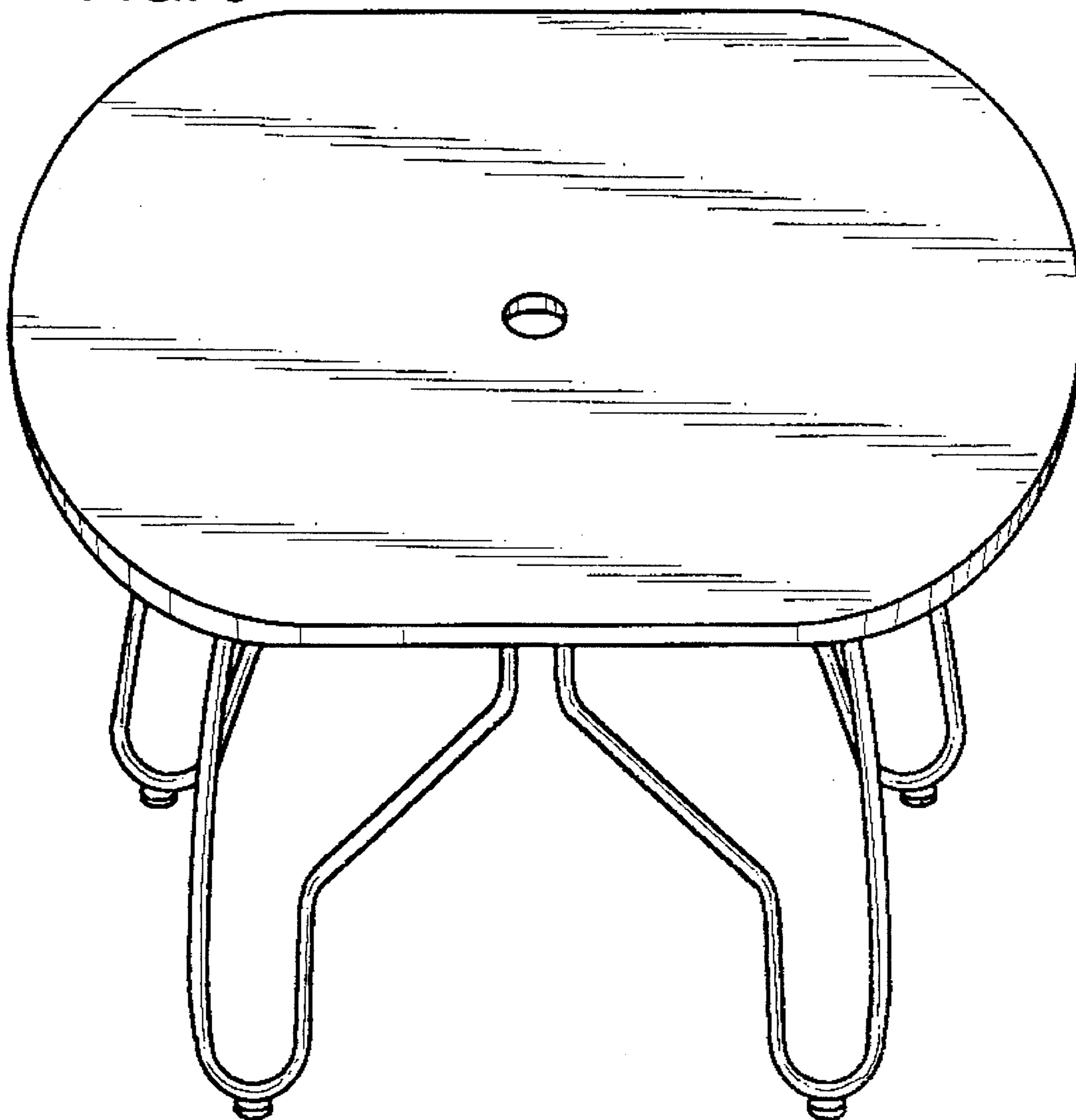

FIG. 6