



US00D372380S

# United States Patent [19]

[11] Patent Number: **Des. 372,380**

Montalbo et al.

[45] Date of Patent: **\*\*Aug. 6, 1996**

## [54] EARRING RACK

[76] Inventors: **Gary Montalbo**, 1165 H Tunnel Rd., Santa Barbara, Calif. 93105; **Mackey W. Davis**, 10520 Ophir Rd., Auburn, Calif. 95603

[\*\*] Term: **14 Years**

[21] Appl. No.: **36,064**

[22] Filed: **Mar. 13, 1995**

[52] U.S. Cl. .... **D6/467**

[58] Field of Search ..... D6/466, 467, 468, D6/469, 570, 449; 206/566, 6.1, 45.14; 211/13, 4; 312/204; 248/309.2; 109/38

## [56] References Cited

### U.S. PATENT DOCUMENTS

D. 141,790	7/1945	Sacoder .....	D6/449
D. 308,451	6/1990	Hughes et al. ....	D6/449
D. 310,926	10/1990	Bass et al. ....	D6/570
D. 338,127	8/1993	Bass et al. ....	D6/570 X
4,966,287	10/1990	Snyder .....	211/13
5,067,617	11/1991	Caldwell et al. ....	211/13
5,242,048	9/1993	Ellingsworth et al. ....	206/6.1

*Primary Examiner*—James M. Gandy  
*Assistant Examiner*—S. Snapp  
*Attorney, Agent, or Firm*—Marvin E. Jacobs

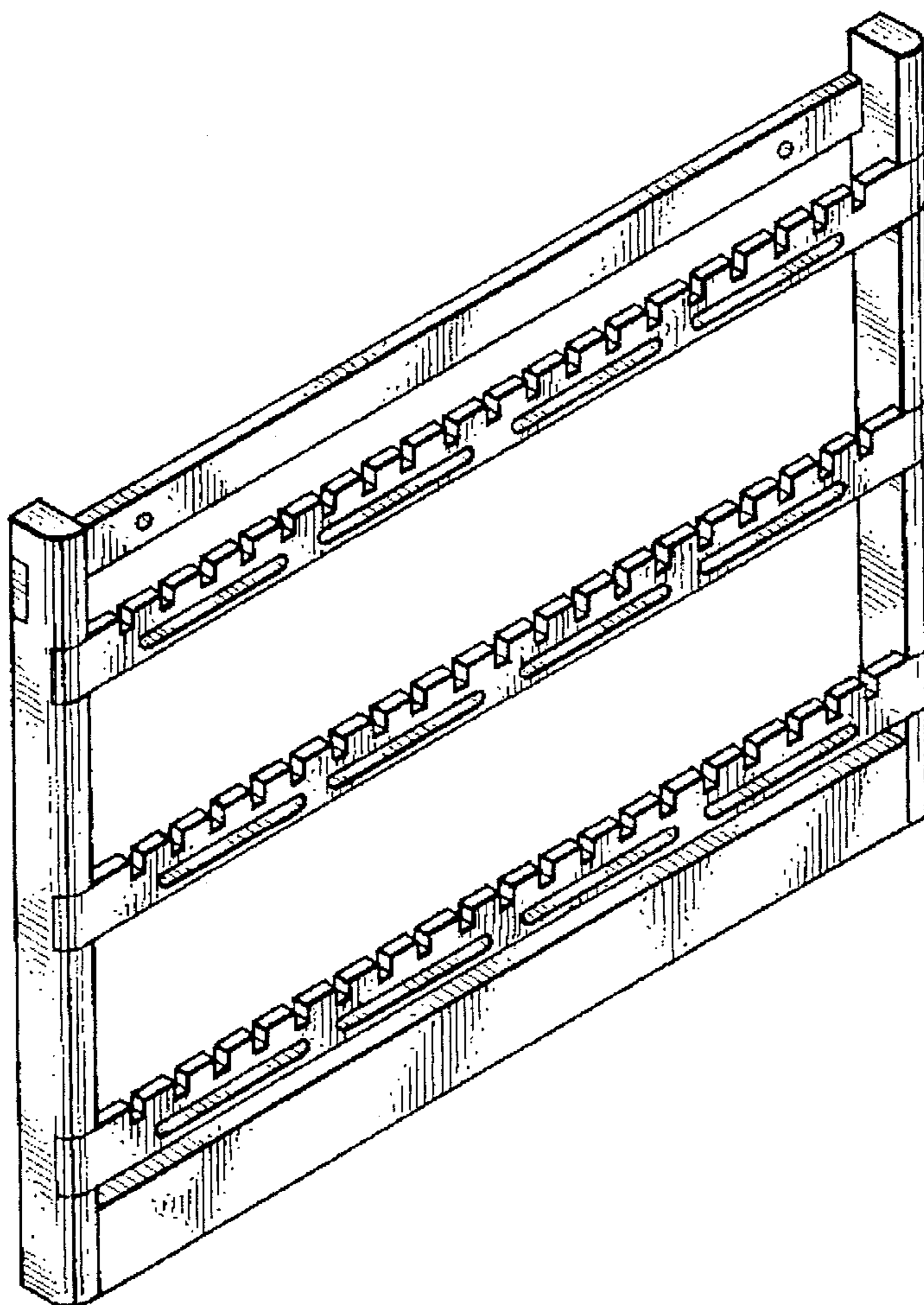
## [57] CLAIM

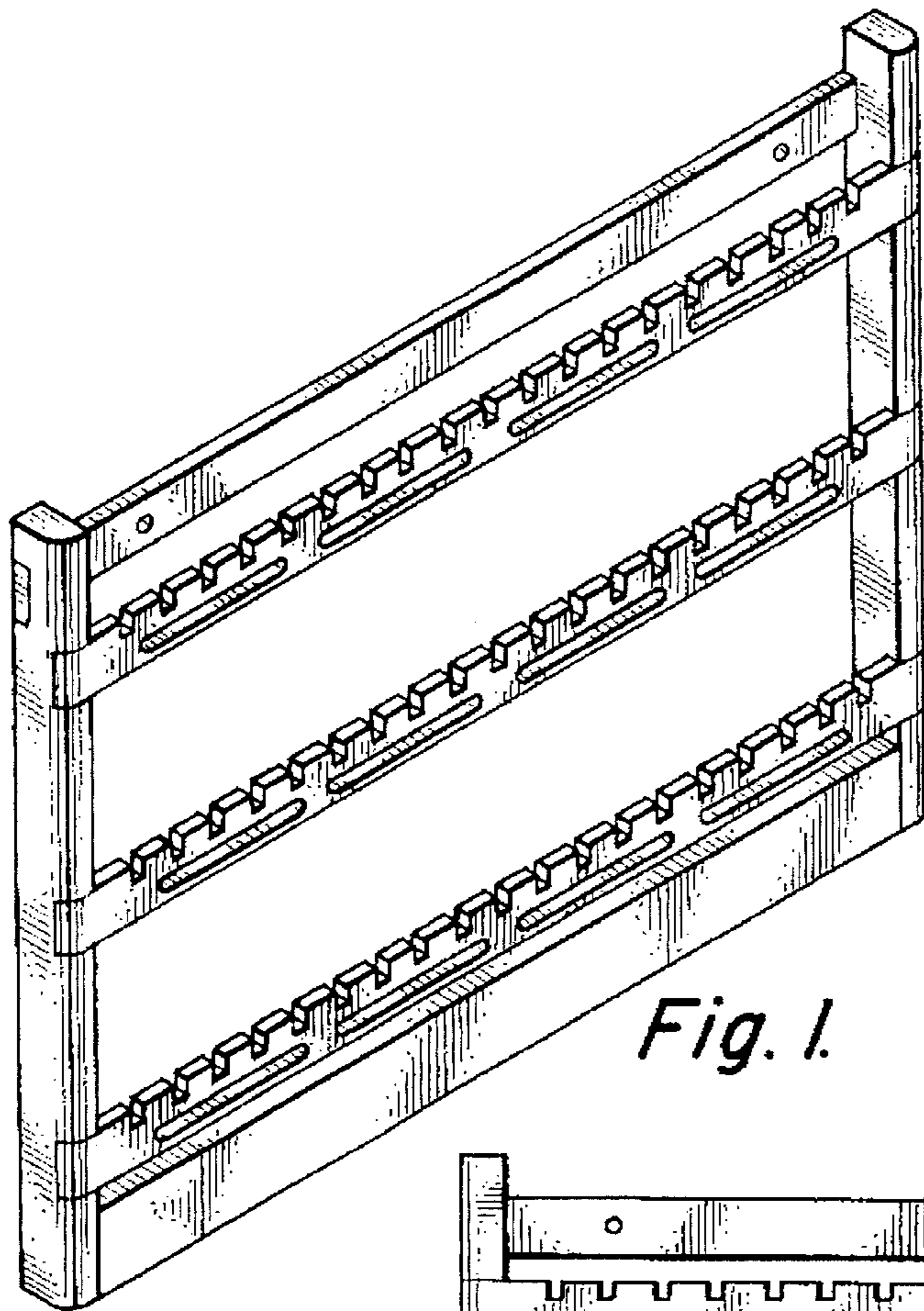
The ornamental design for earring rack, as shown and described.

## DESCRIPTION

FIG. 1 is an isometric view of an earring rack; FIG. 2 is a front view in elevation of the earring rack illustrated in FIG. 1; FIG. 3 is a top plan view of the earring rack illustrated in FIG. 1; FIG. 4 is a plan view of the earring rack illustrated in FIG. 1; FIG. 5 is a left side view of the earring rack, illustrated in FIG. 1, the right side view being a mirror image thereof; FIG. 6 is a rear view in elevation of the earring rack illustrated in FIG. 1; and, FIG. 7 is an isometric view similar to FIG. 1 of an alternate embodiment of the earring rack, the only difference residing in the width and the length of the rack as well as the number of horizontal supports.

**1 Claim, 2 Drawing Sheets**

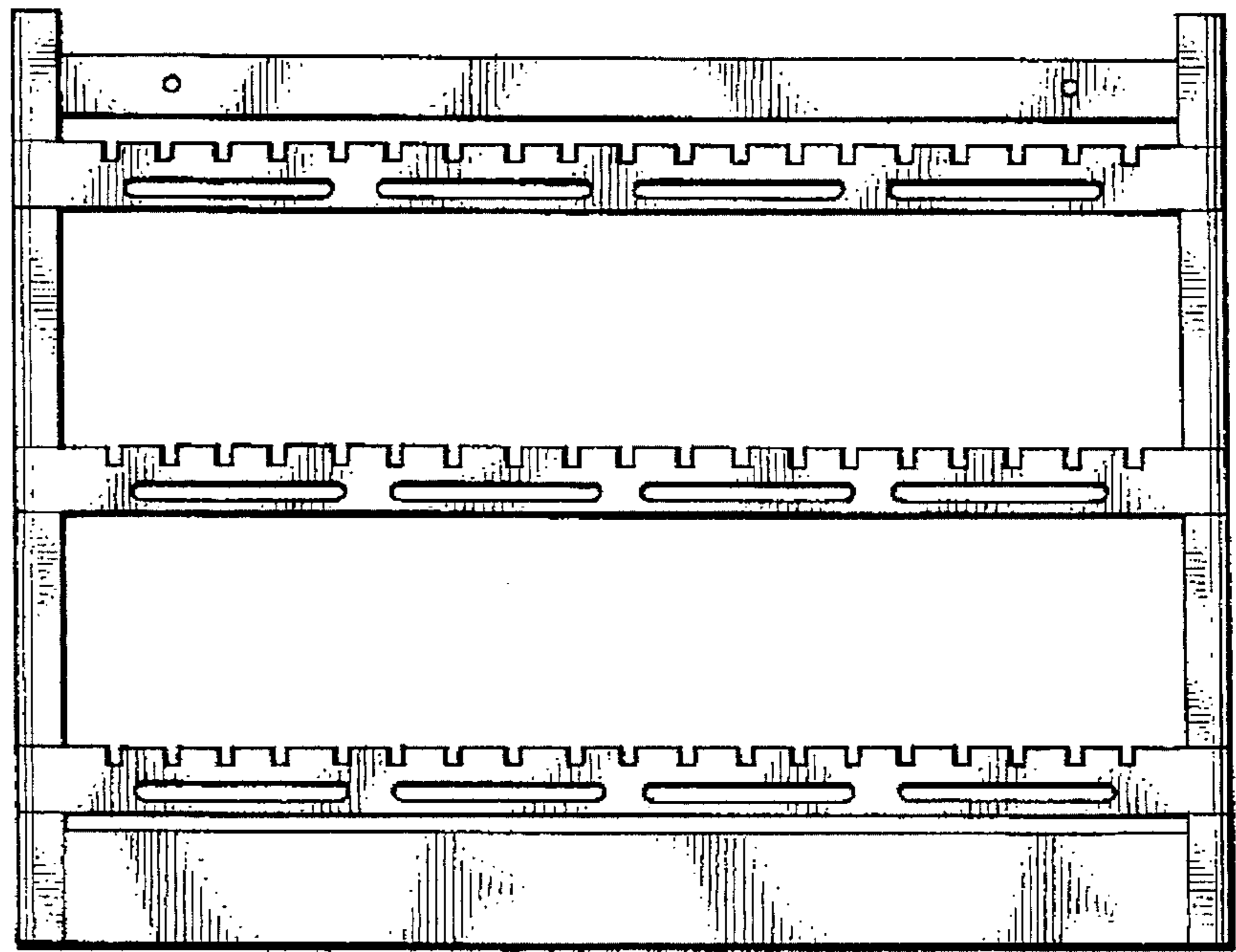




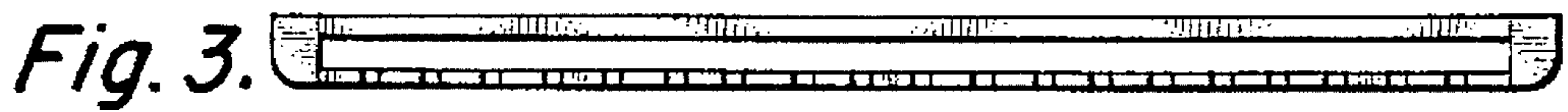
*Fig. 1.*



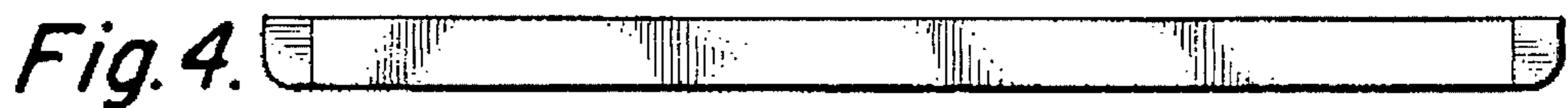
*Fig. 5.*



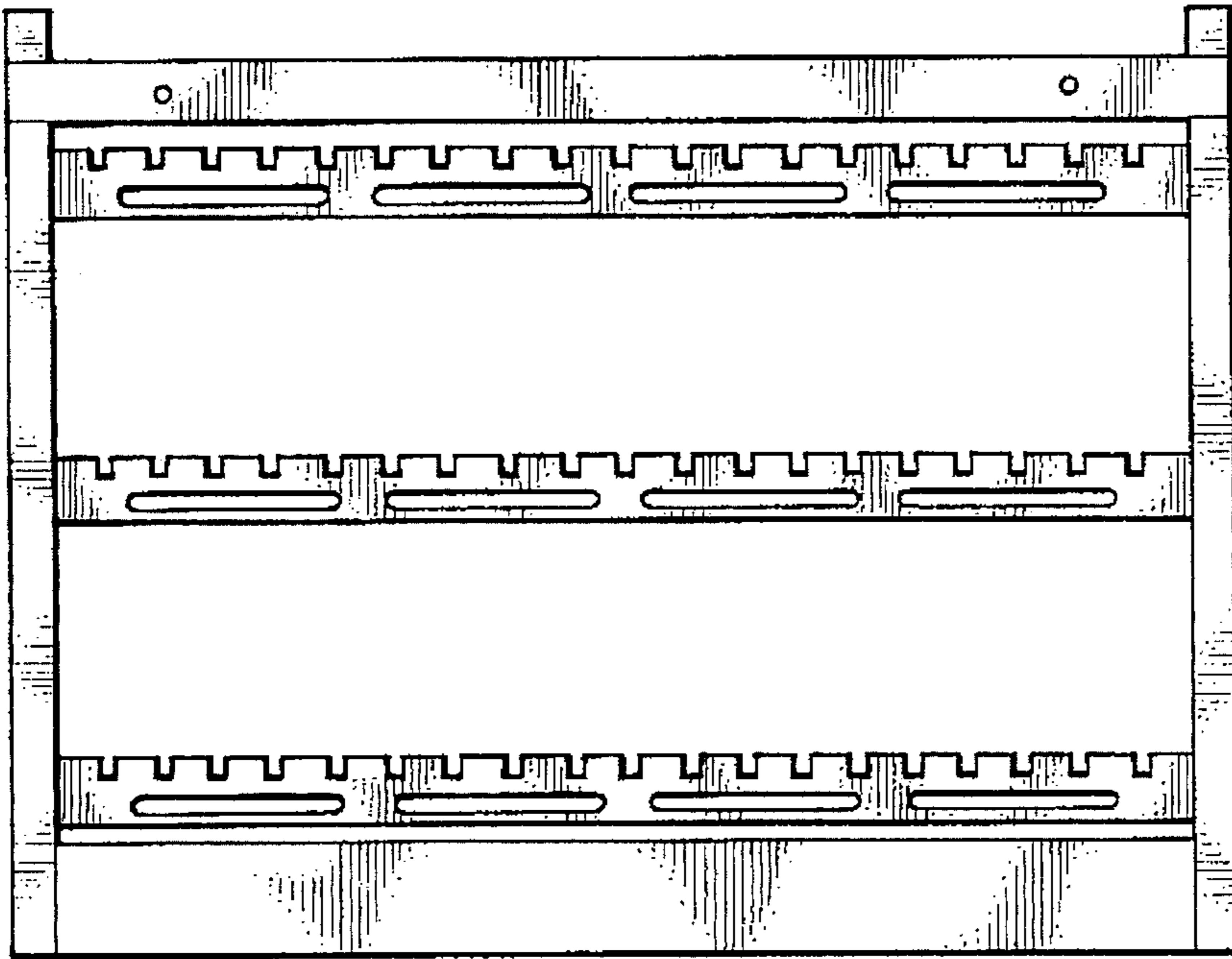
*Fig. 2.*



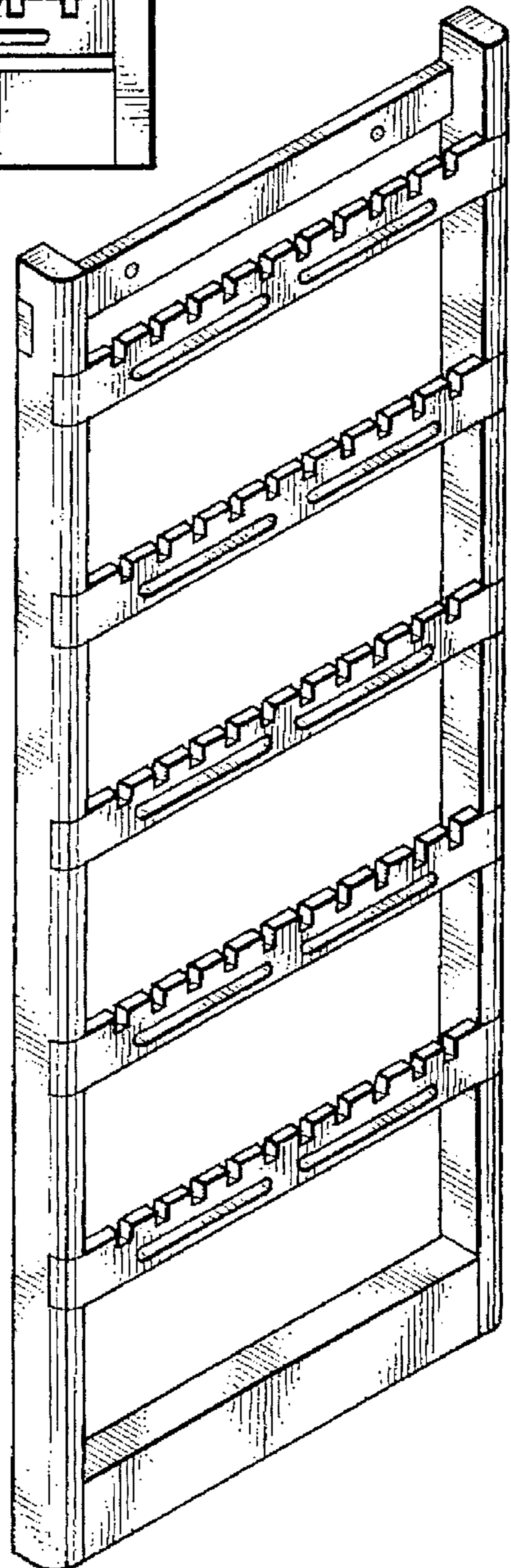
*Fig. 3.*



*Fig. 4.*



*Fig. 6.*



*Fig. 7.*