



US00D372362S

United States Patent [19]

[11] Patent Number: **Des. 372,362**

Bryant et al.

[45] Date of Patent: ****Aug. 6, 1996**

[54] **GOLF BAG BOTTOM ASSEMBLY**

[75] Inventors: **Leslie J. Bryant**, Peoria; **John A. Solheim**, Phoenix, both of Ariz.

[73] Assignee: **Karsten Manufacturing Corporation**, Phoenix, Ariz.

[**] Term: **14 Years**

[21] Appl. No.: **42,571**

[22] Filed: **Aug. 14, 1995**

[52] U.S. Cl. **D3/320**

[58] Field of Search D3/255, 320; 206/315.1, 206/315.2, 315.3, 315.4, 315.5, 315.6, 315.7, 315.8, 315.9

1,628,186 5/1927 Pierce et al. 206/315.3
 1,684,111 9/1928 Rau 206/315.3
 1,767,548 6/1930 Noe 206/315.3
 1,902,644 3/1933 Hotze 206/315.8

Primary Examiner—Doris V. Coles
Assistant Examiner—Catherine R. Oliver
Attorney, Agent, or Firm—Darrell F. Marquette; Herbert E. Haynes, Jr.

[57] CLAIM

The ornamental design for a golf bag bottom assembly, as shown and described.

DESCRIPTION

FIG. 1 is a perspective view of a golf bag bottom assembly showing our new design;
 FIG. 2 is a top plan view thereof;
 FIG. 3 is a side elevational view thereof;
 FIG. 4 is a bottom view thereof;
 FIG. 5 is a sectional view, taken along the lines 5—5 in FIG. 2; and,
 FIG. 6 is a front elevational view.

1 Claim, 3 Drawing Sheets

[56] References Cited

U.S. PATENT DOCUMENTS

D. 205,363 7/1966 Penna D3/255
 D. 206,009 10/1966 Wilkens D3/255
 D. 208,481 9/1967 Murray, Jr. D3/255 X
 D. 252,774 8/1979 Gregory D3/255 X

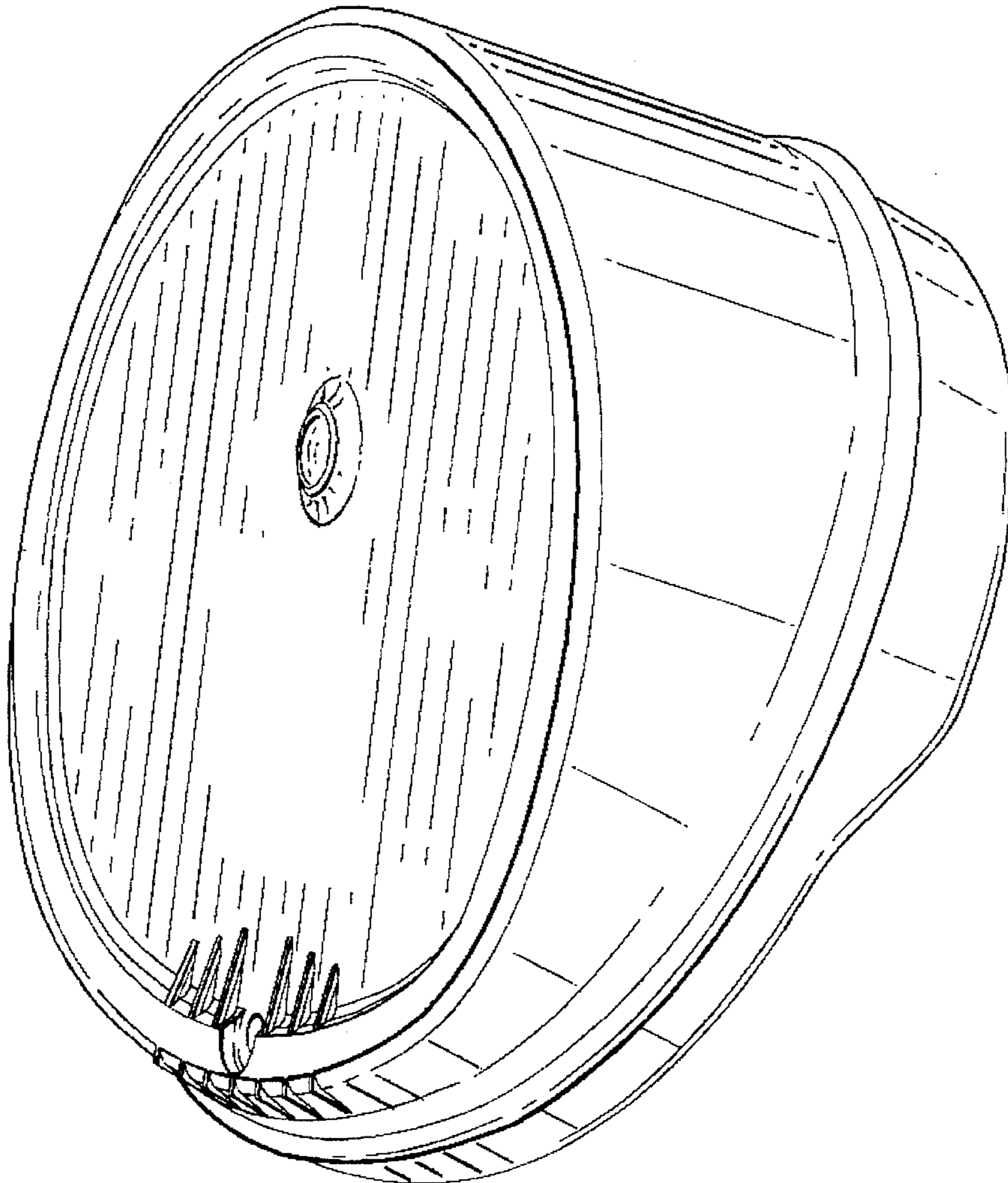

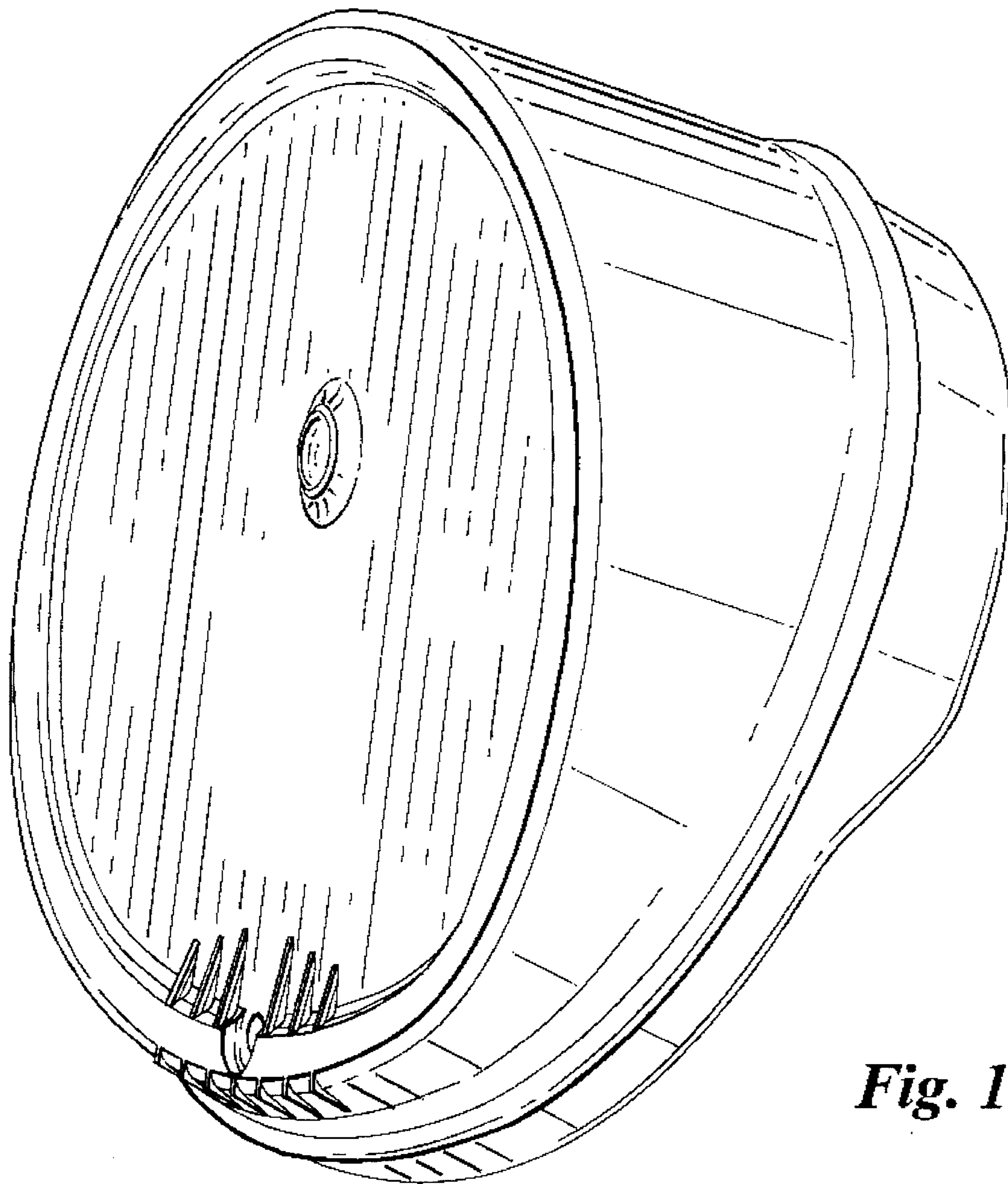

Fig. 1

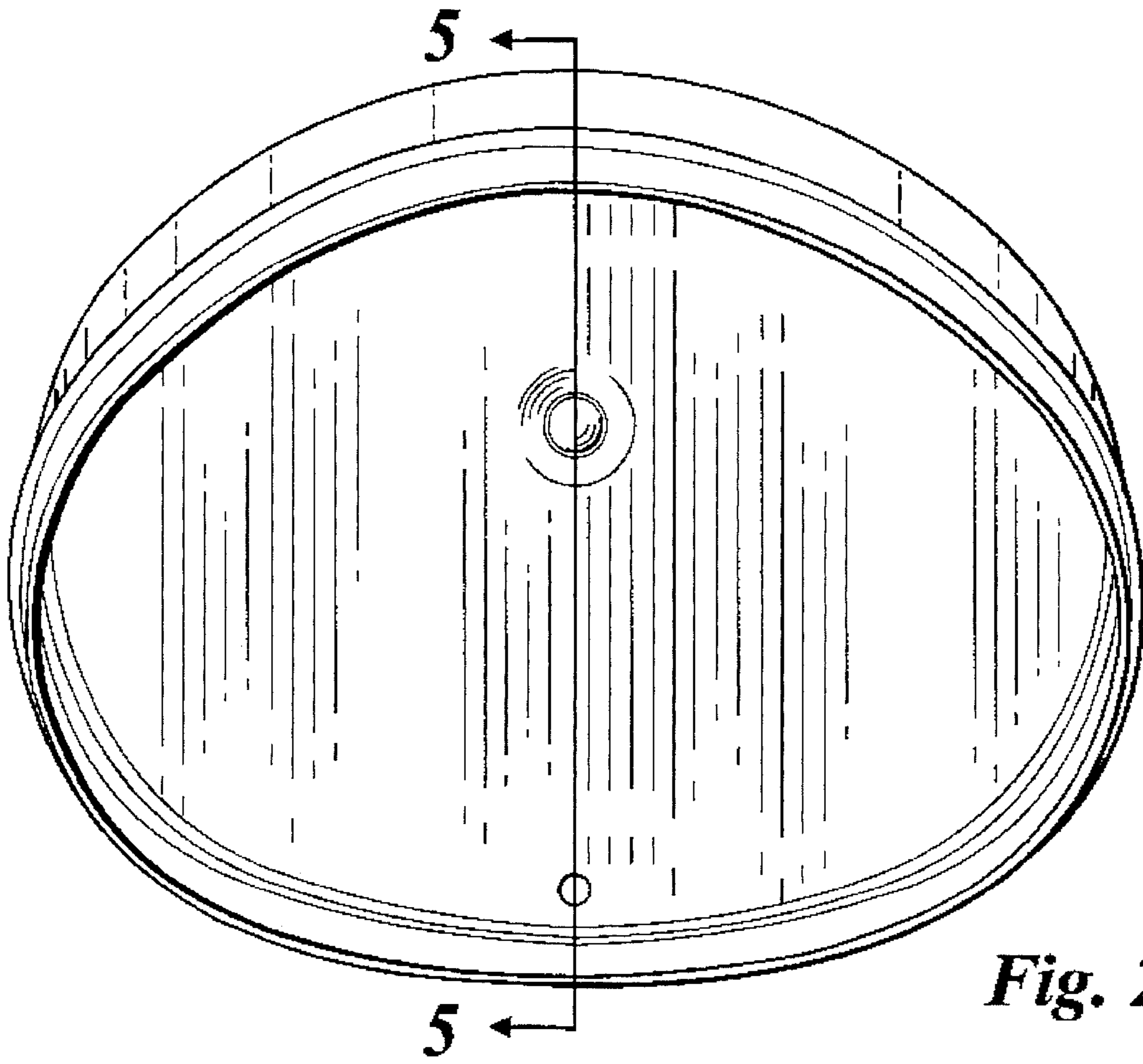

Fig. 2

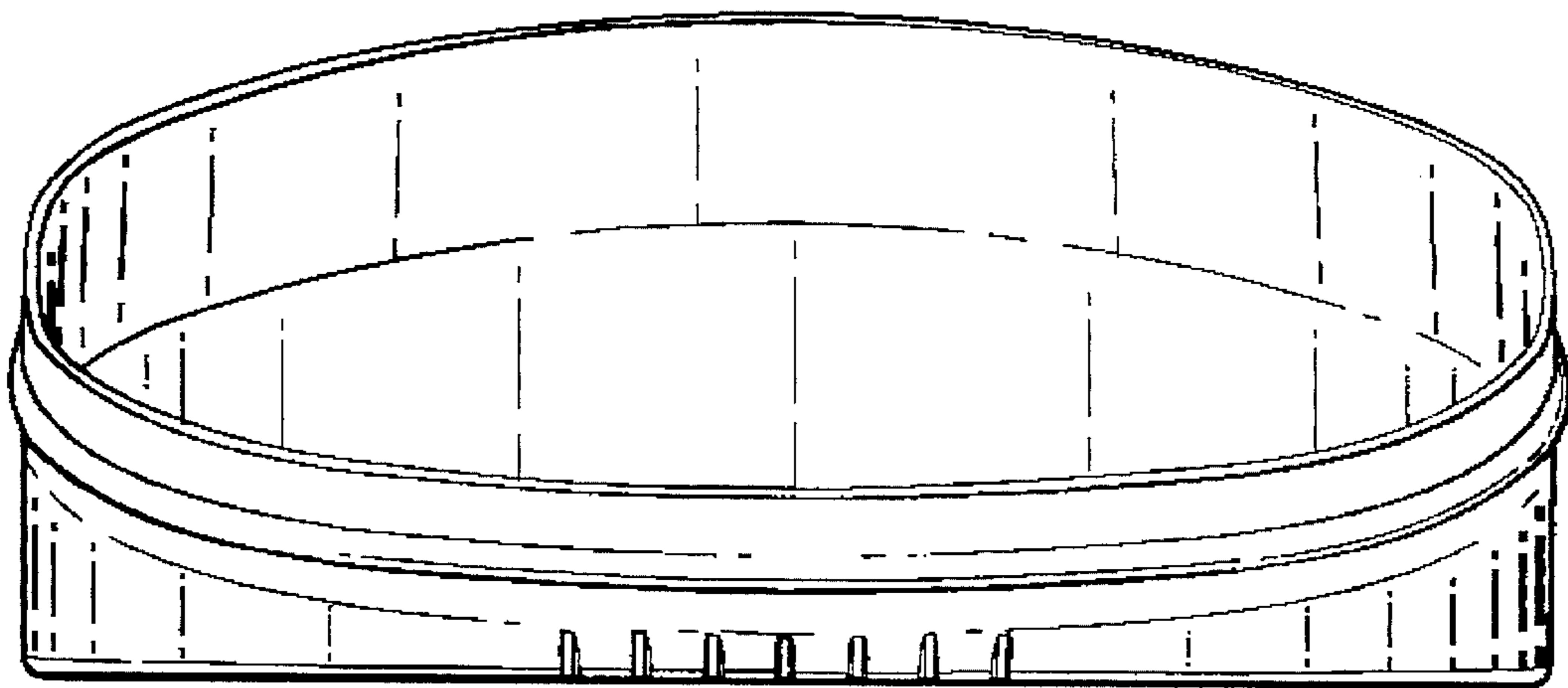

Fig. 3

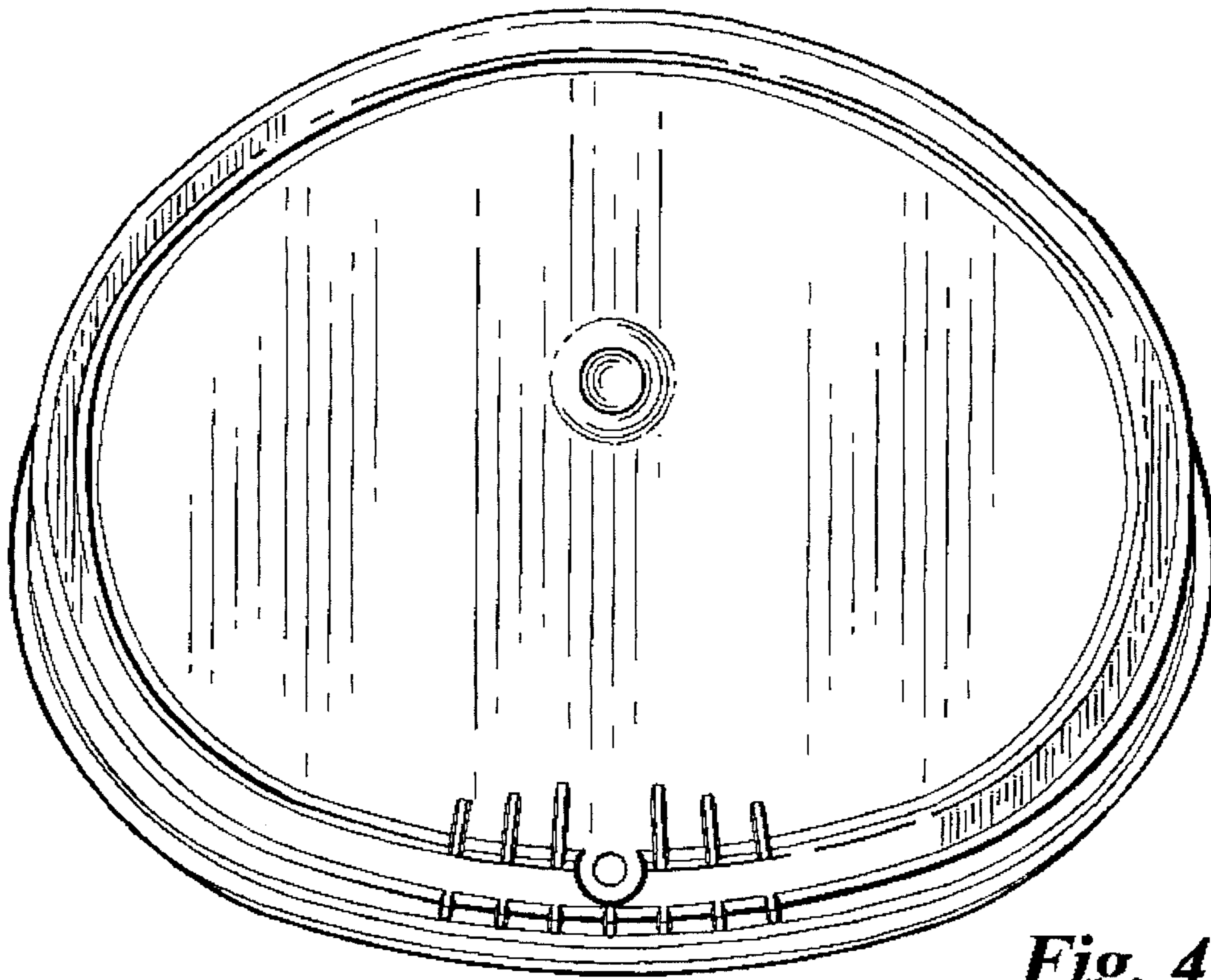

Fig. 4

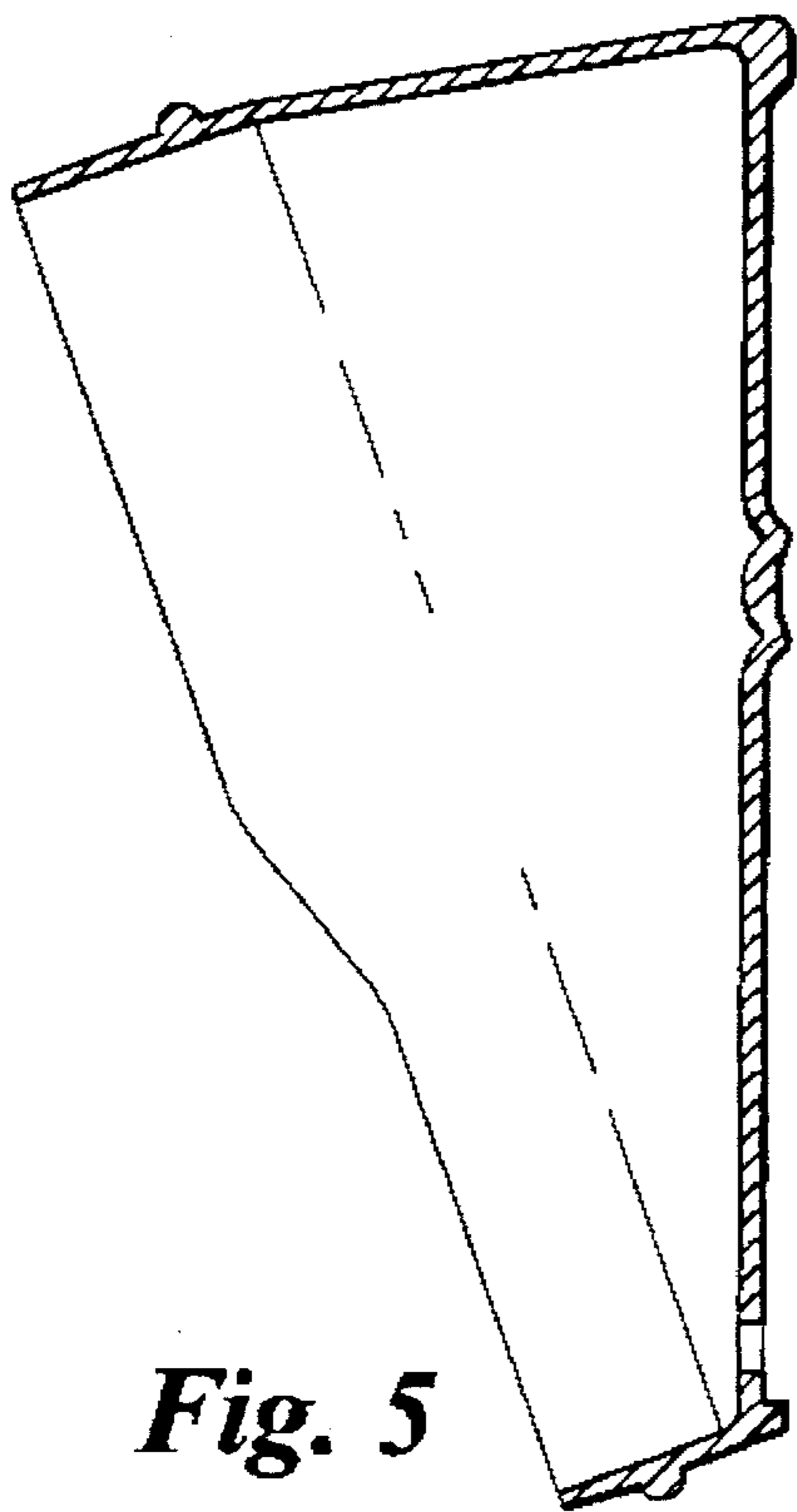

Fig. 5

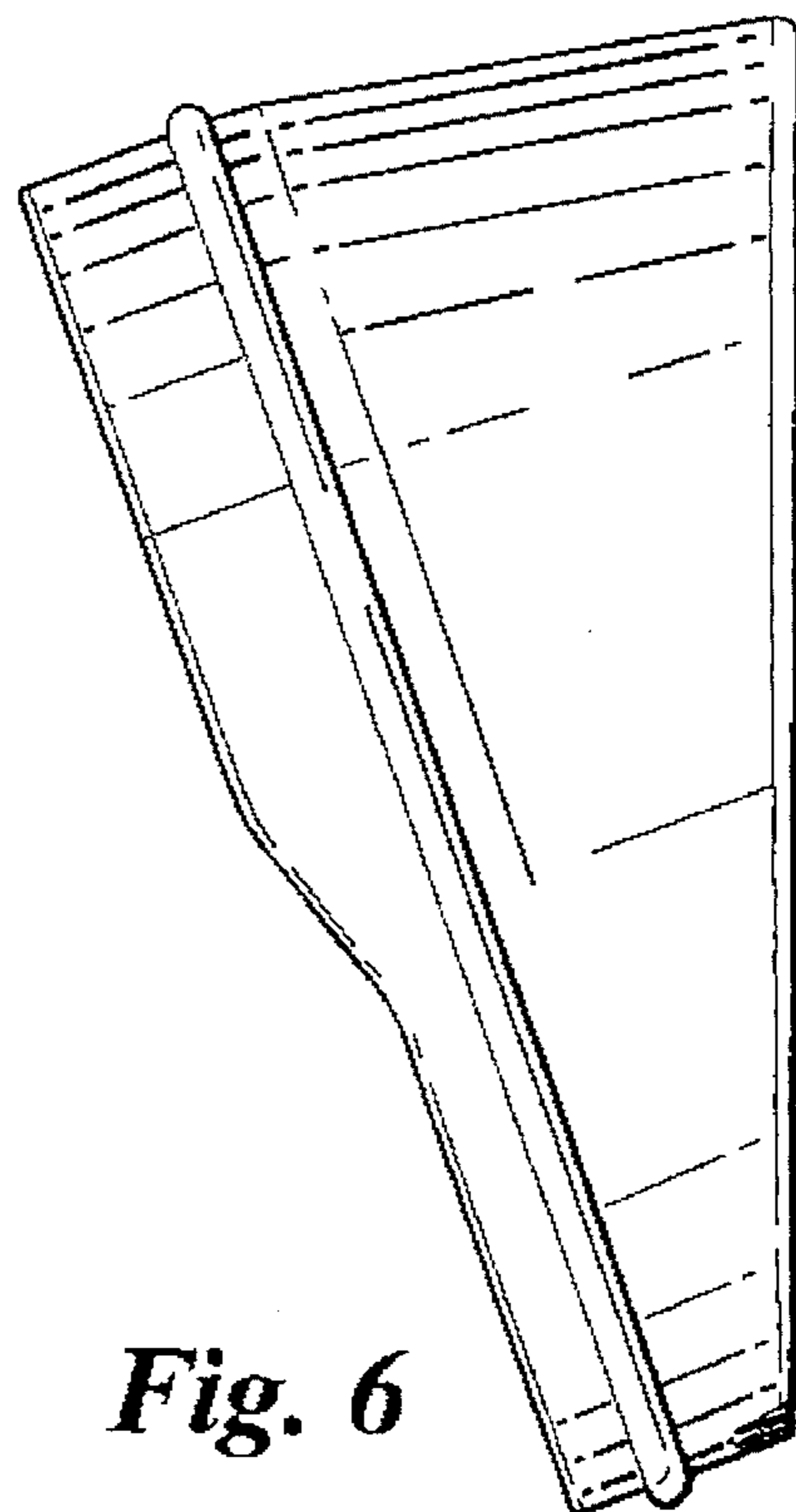

Fig. 6