



US00D372230S

United States Patent [19] Samborsky

[11] Patent Number: **Des. 372,230**

[45] Date of Patent: ****Jul. 30, 1996**

[54] **TENNIS MOTIF COMPUTER DUST COVER KIT**

2,492,262 12/1949 Boyden et al. 312/208.3 X
4,922,980 5/1990 Parker 150/165

[76] Inventor: **Virgil L. Samborsky**, 5202 Hahn Ave.,
Fairborn, Ohio 45324

[**] Term: **14 Years**

[21] Appl. No.: **39,058**

[22] Filed: **May 19, 1995**

[52] U.S. Cl. **D14/114**

[58] **Field of Search** D14/114; D3/274;
D6/165, 307, 417; D2/615; D21/2, 7, 11,
14, 204, 212, 223; 150/154, 158, 164, 165;
181/200, 201; 206/315.1, 315.4, 320, 586;
312/208.3

[56] **References Cited**

U.S. PATENT DOCUMENTS

D. 264,229	5/1982	Hanzawa	D21/13
D. 265,561	7/1982	Cottrell	D14/114
D. 291,203	8/1987	Silver	D14/114
D. 319,218	8/1991	Sakaguchi et al.	D14/100
D. 323,929	2/1992	Hodson	D3/30.1
D. 349,893	8/1994	Bennett	D14/114
D. 361,558	8/1995	Siano, Jr.	D14/114
D. 361,559	8/1995	Siano, Jr.	D14/114

OTHER PUBLICATIONS

MacWarehouse Mar. 1992 p. 69 *Basic Needs Nylon Dust Covers.*

Primary Examiner—Freda Nunn
Attorney, Agent, or Firm—Biebel & French

[57] **CLAIM**

The ornamental design for a tennis motif computer dust cover kit, as shown and described.

DESCRIPTION

FIG. 1 is a perspective view of a tennis motif computer dust cover kit in accordance with my invention;
FIG. 2 is a top view thereof;
FIG. 3 is a front view thereof;
FIG. 4 is a back view thereof;
FIG. 5 is a left-hand side view thereof;
FIG. 6 is a right-hand side view thereof; and,
FIG. 7 is a bottom view thereof.
The broken lines are shown in the figures for illustrative purposes only and form no part of the claimed design.

1 Claim, 3 Drawing Sheets

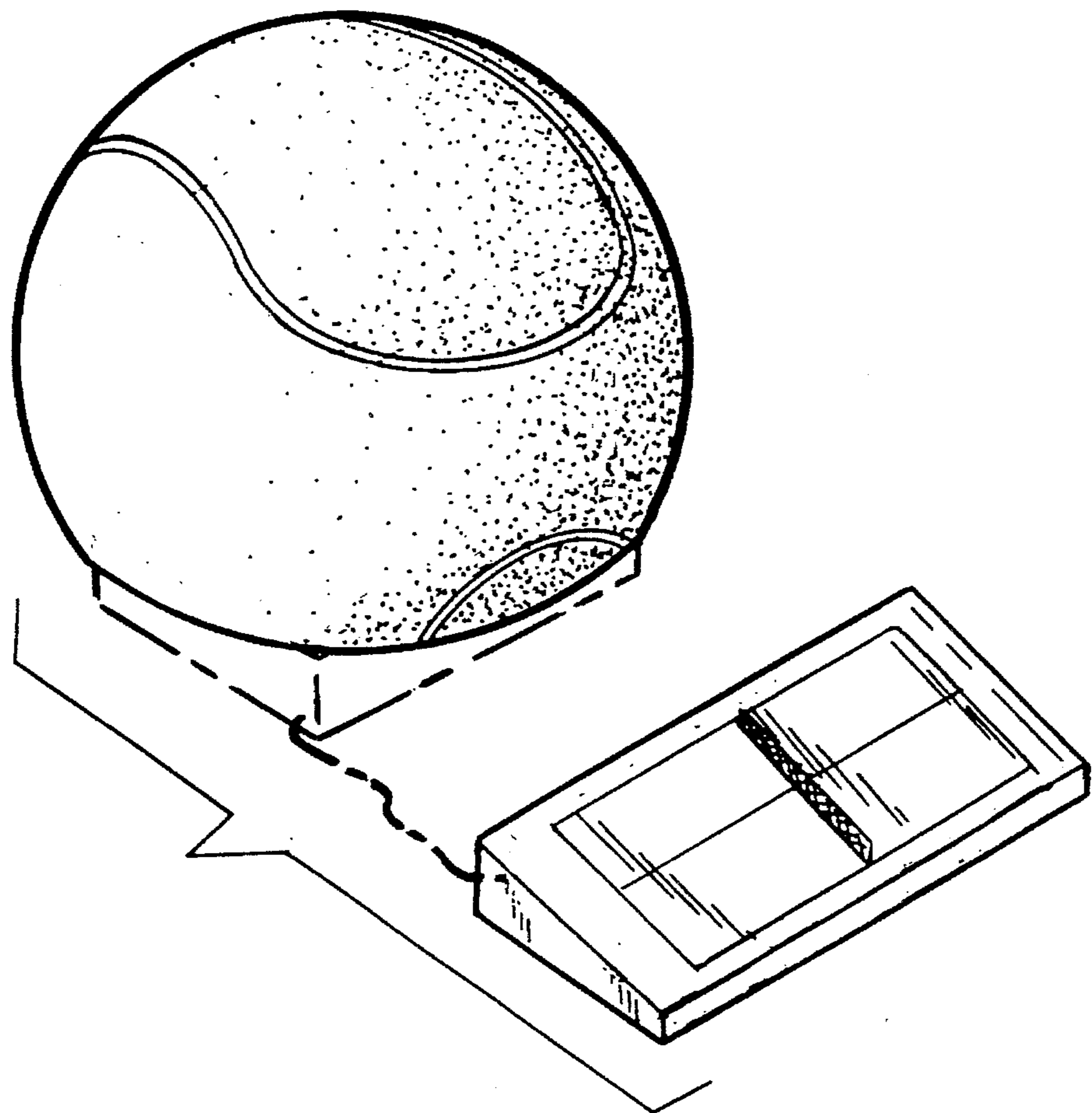

FIG-1

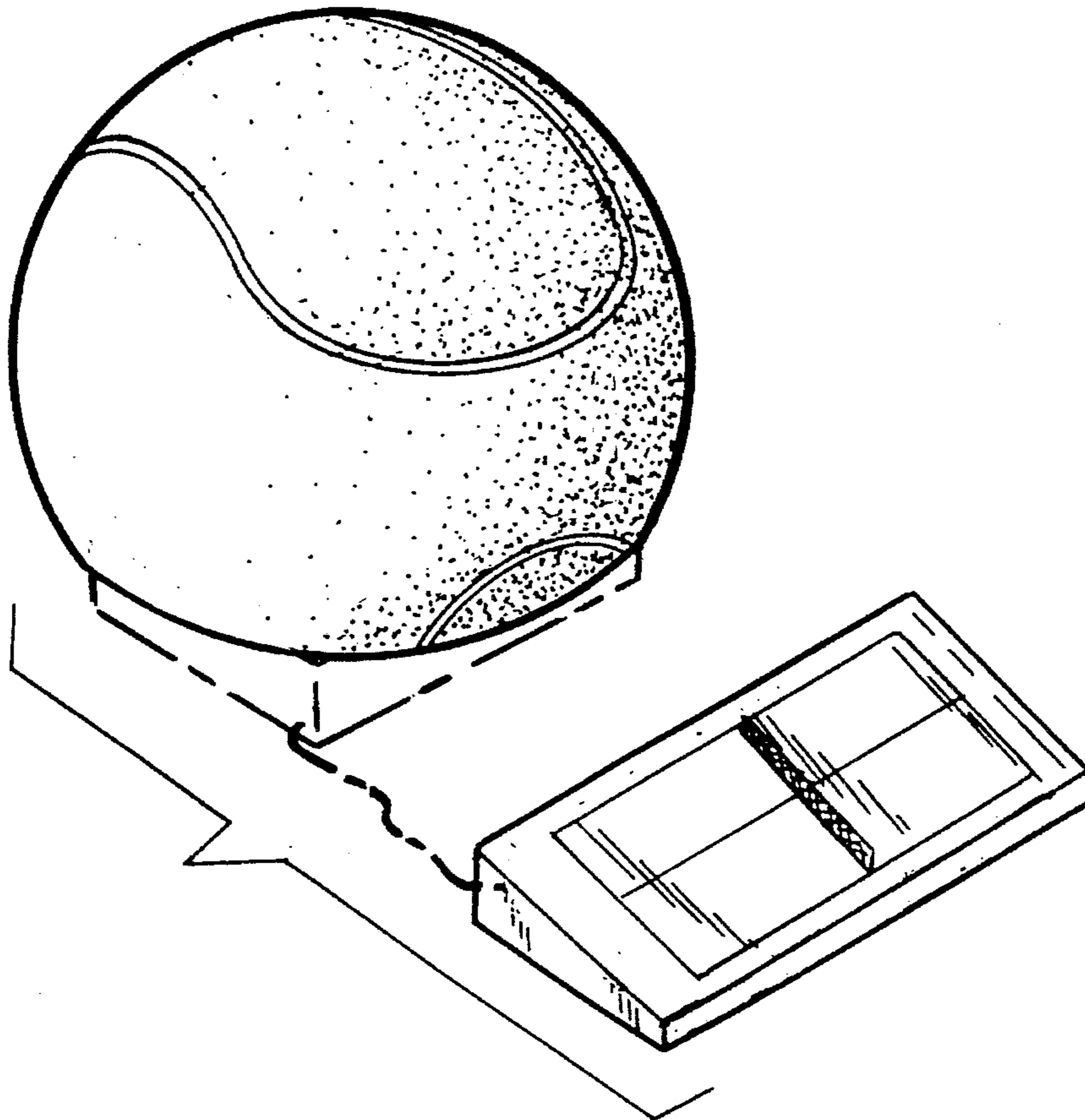

FIG-2

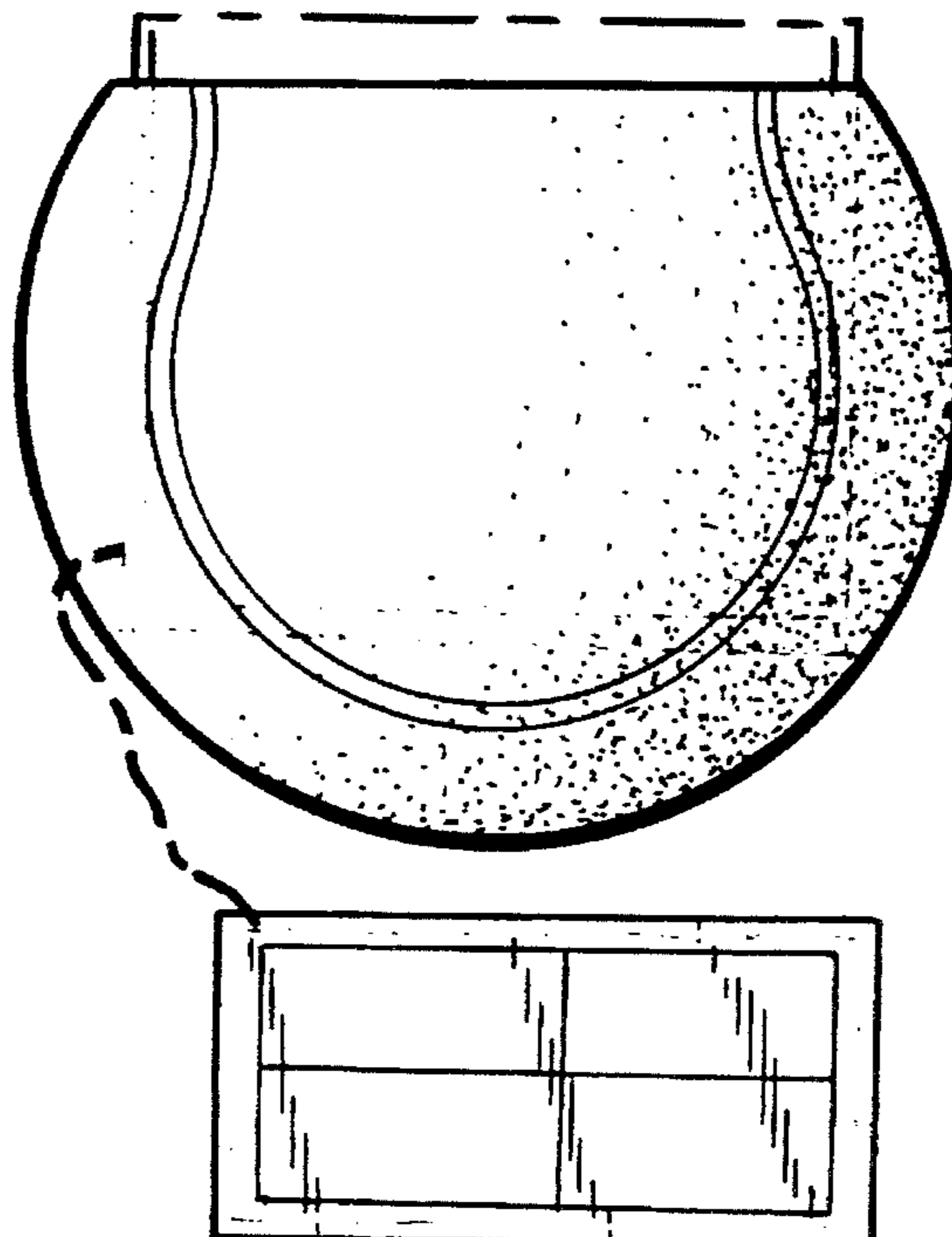

FIG - 3

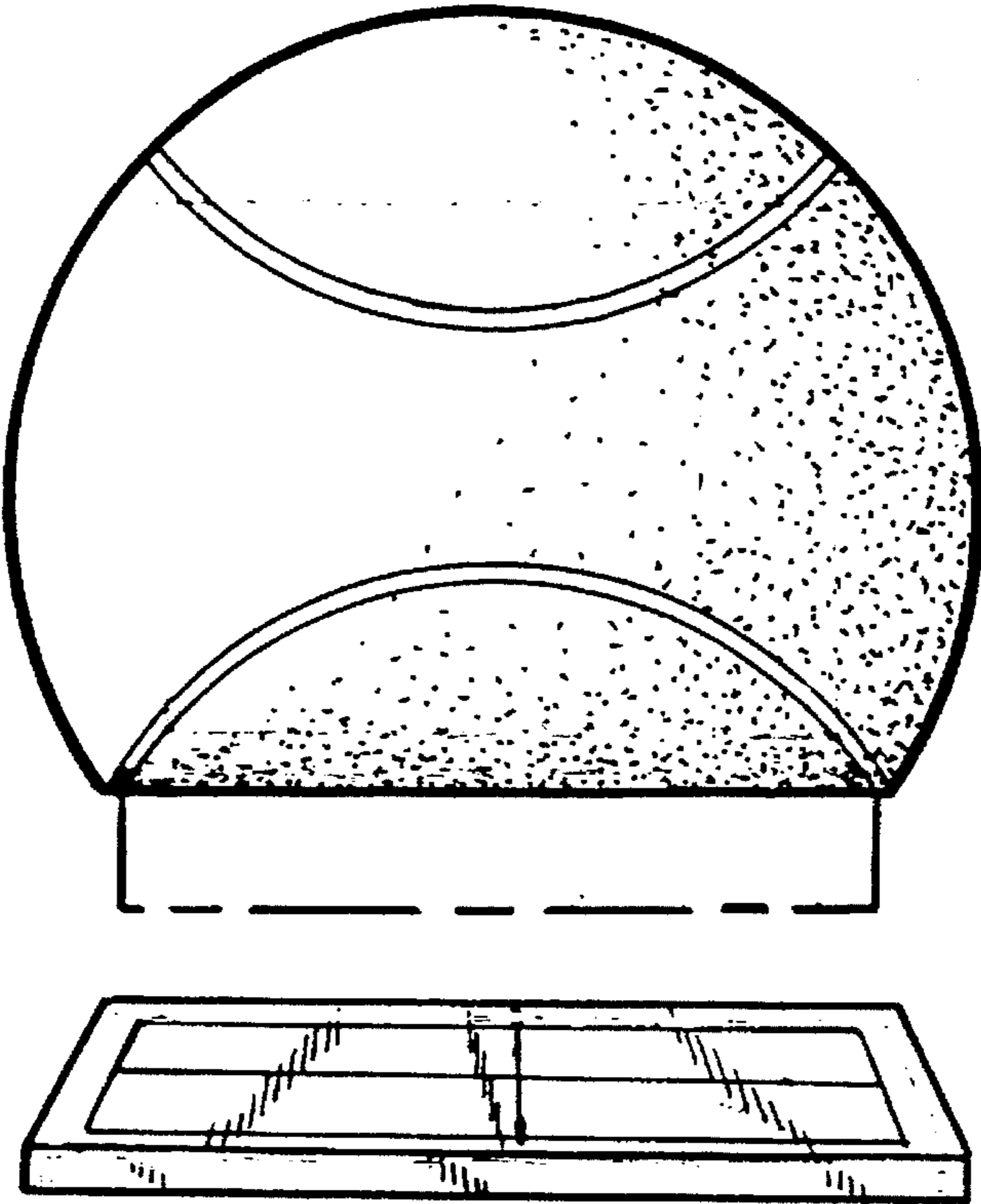

FIG - 4

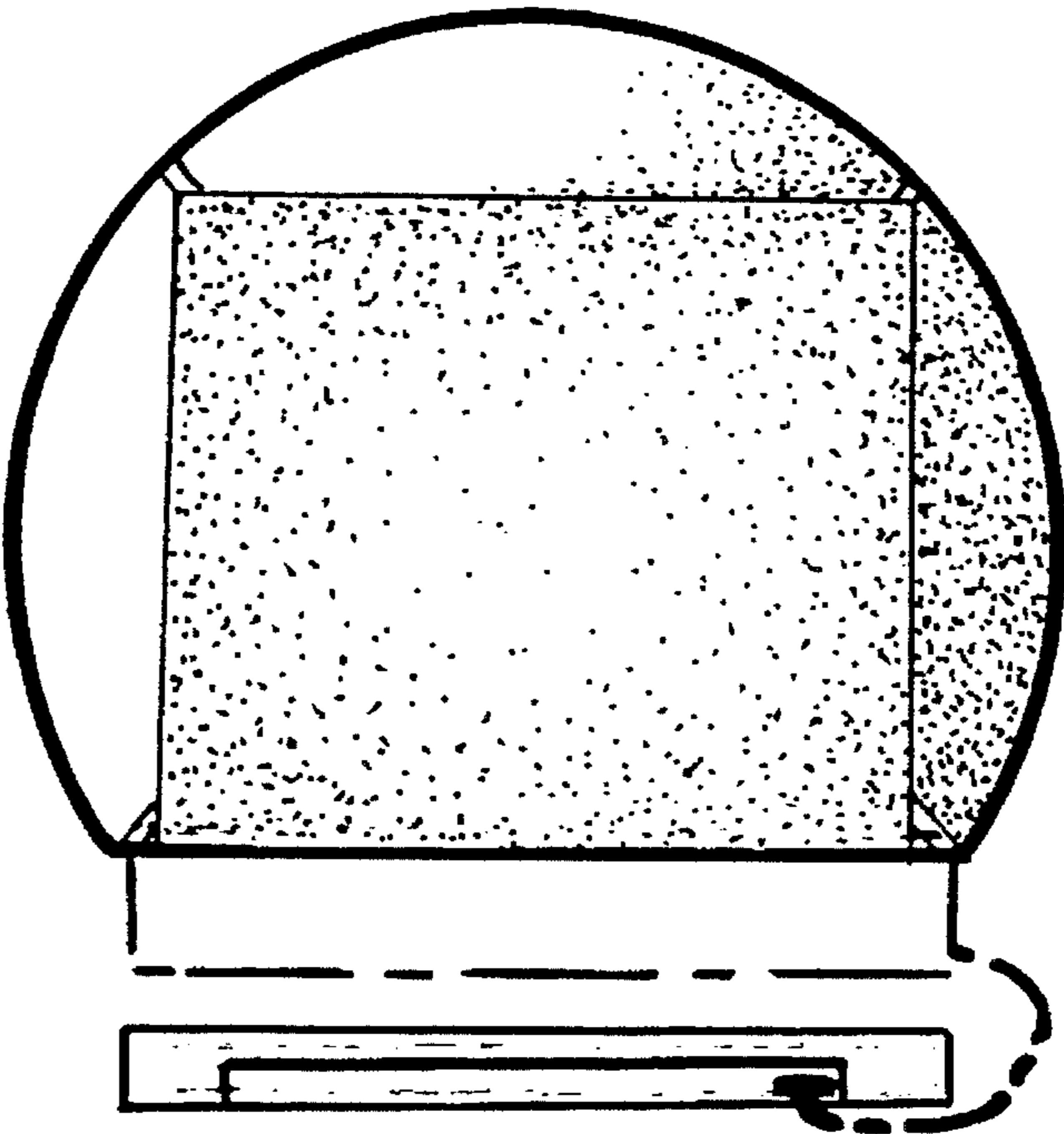

FIG-5

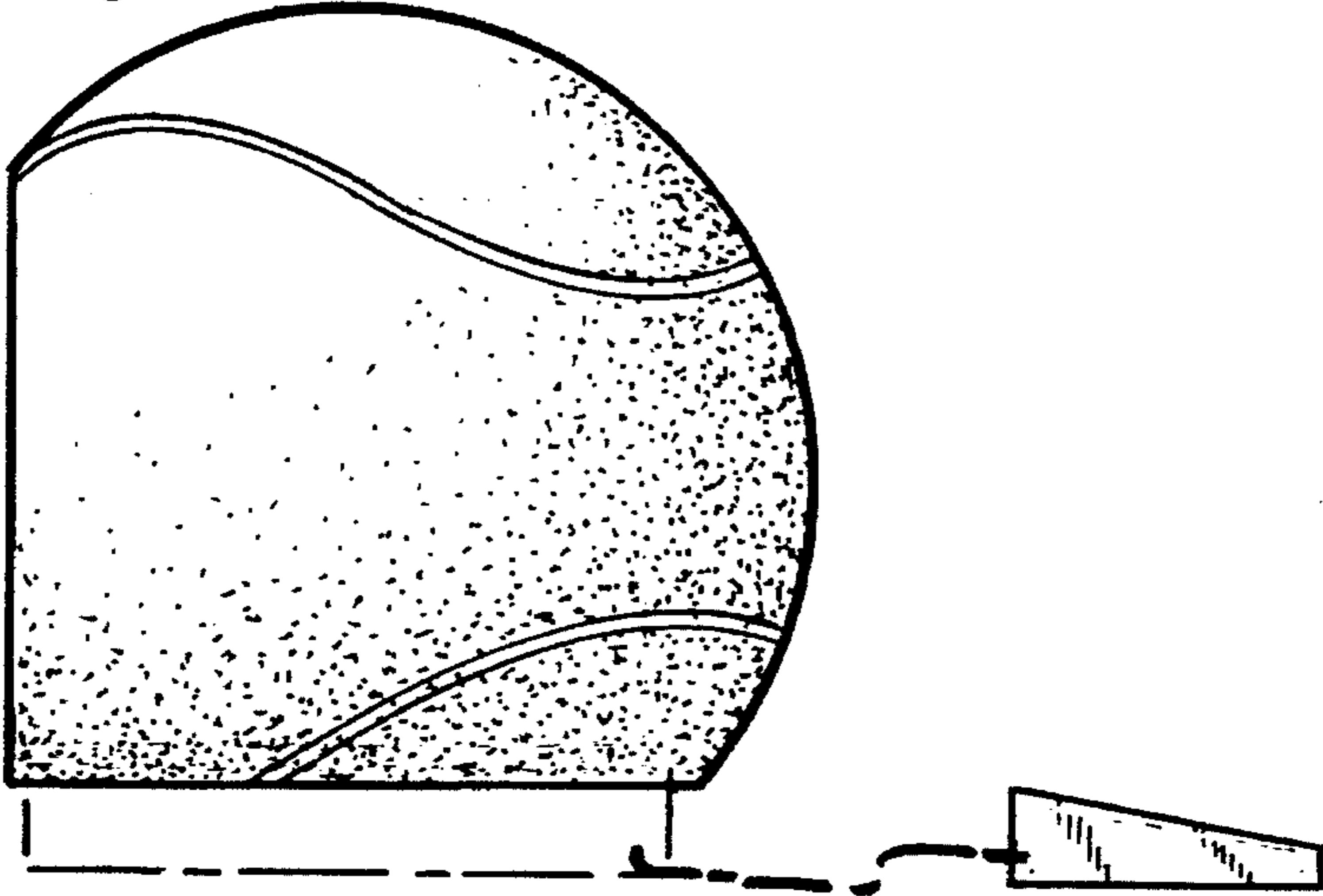

FIG-6

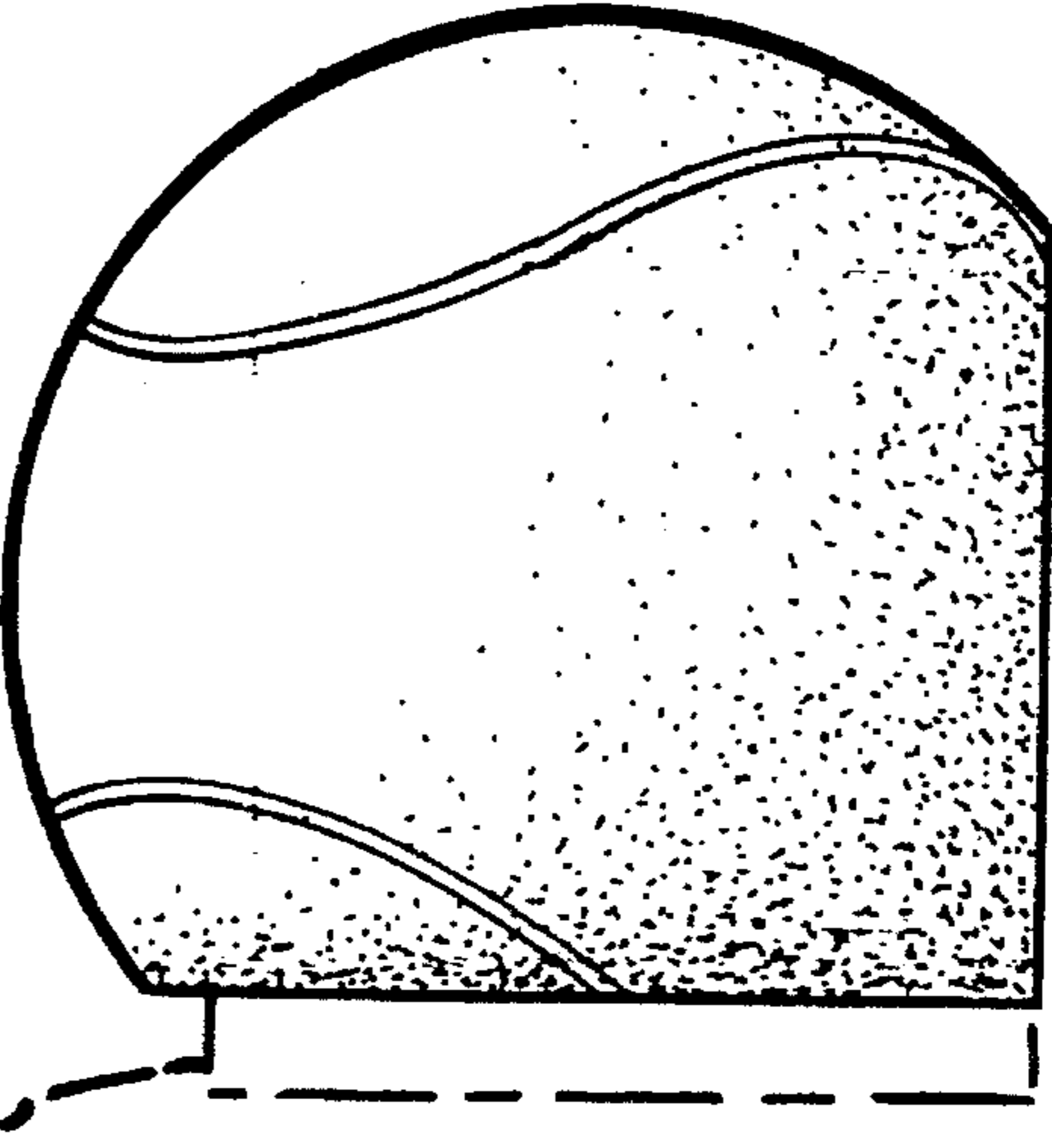

FIG-7

