



US00D372124S

United States Patent [19] Dammers

[11] Patent Number: **Des. 372,124**

[45] Date of Patent: ****Jul. 30, 1996**

[54] **CLEANING BRUSH CADDY**

[76] Inventor: **Keith A. Dammers**, 433 Mill Rd., Unit 75, Calverton, N.Y. 11933

[**] Term: **14 Years**

[21] Appl. No.: **34,650**

[22] Filed: **Feb. 9, 1995**

[52] U.S. Cl. **D3/315**

[58] Field of Search D3/315, 310, 905; D4/199; D32/35; D6/512, 513, 416; 220/507; 206/209, 211, 214, 361, 362, 362.3, 379; 408/241; 217/7, 18

[56] **References Cited**

U.S. PATENT DOCUMENTS

D. 282,317	1/1986	Herzfeld	D4/104
D. 282,752	2/1986	Olivetti	D19/26
D. 301,422	6/1989	Schmidt	D4/199 X
149,479	4/1874	Hunt	217/18
188,609	3/1877	Duc, Jr.	217/18
262,313	8/1882	Reed	217/18

2,552,333	5/1951	Lieberman	220/507 X
3,745,025	7/1973	Hollinger	217/18 X
4,144,609	3/1979	Dubs	15/104.2
4,955,478	9/1990	Rau et al.	206/379
5,035,553	7/1991	Lo	408/241 R

Primary Examiner—Doris V. Coles
Assistant Examiner—Catherine R. Oliver

[57] **CLAIM**

The ornamental design for the cleaning brush caddy, as shown and described.

DESCRIPTION

FIG. 1 is a front assembly view of the cleaning brush caddy showing my new design;
FIG. 2 is a rear assembly view thereof;
FIG. 3 is a left side assembly view thereof;
FIG. 4 is a right side assembly view thereof;
FIG. 5 is a top assembly view thereof;
FIG. 6 is a bottom assembly view thereof;
FIG. 7 is a cross-sectional view thereof; and,
FIG. 8 is a perspective view thereof.

1 Claim, 4 Drawing Sheets

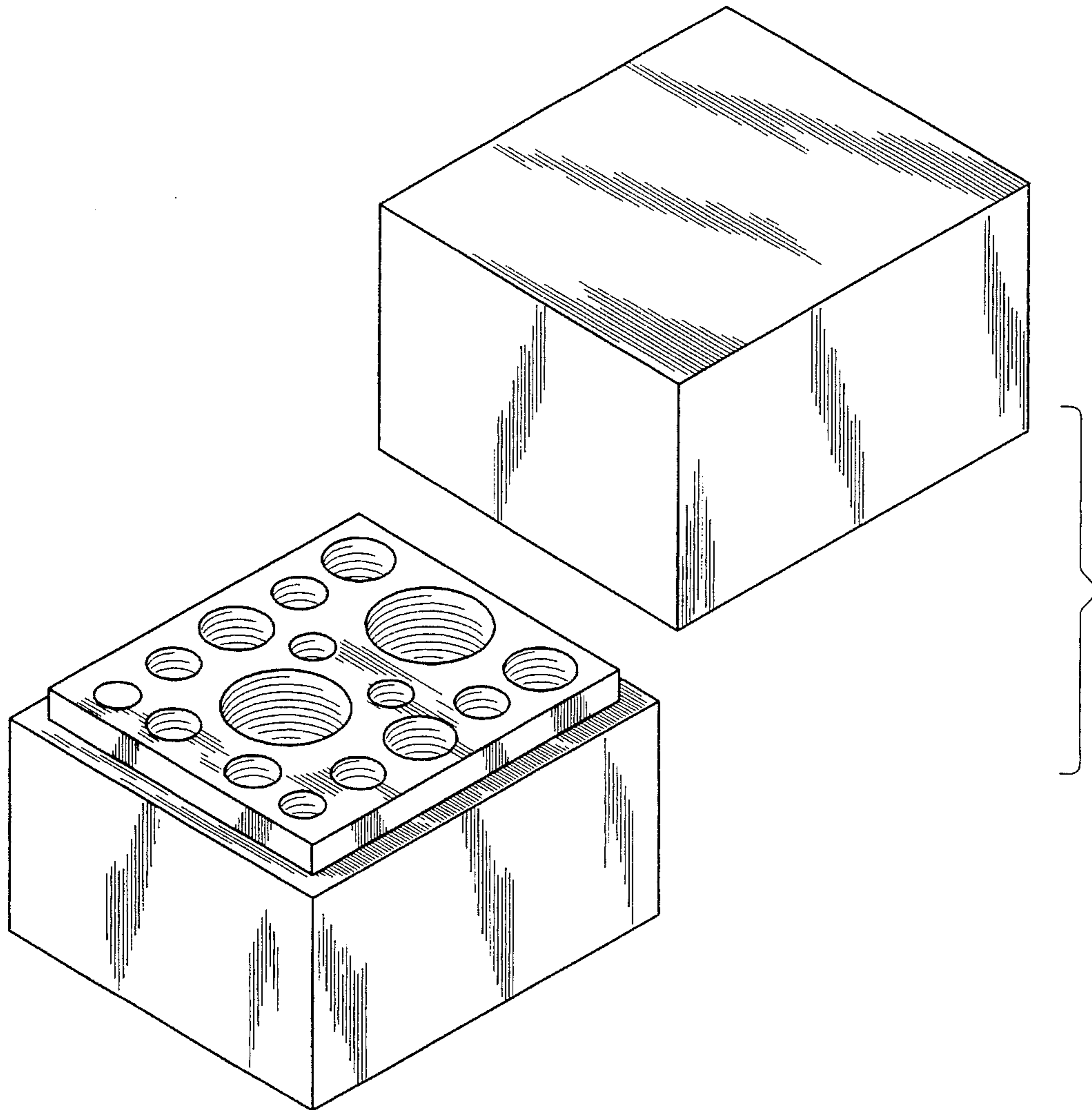

FIG. 1

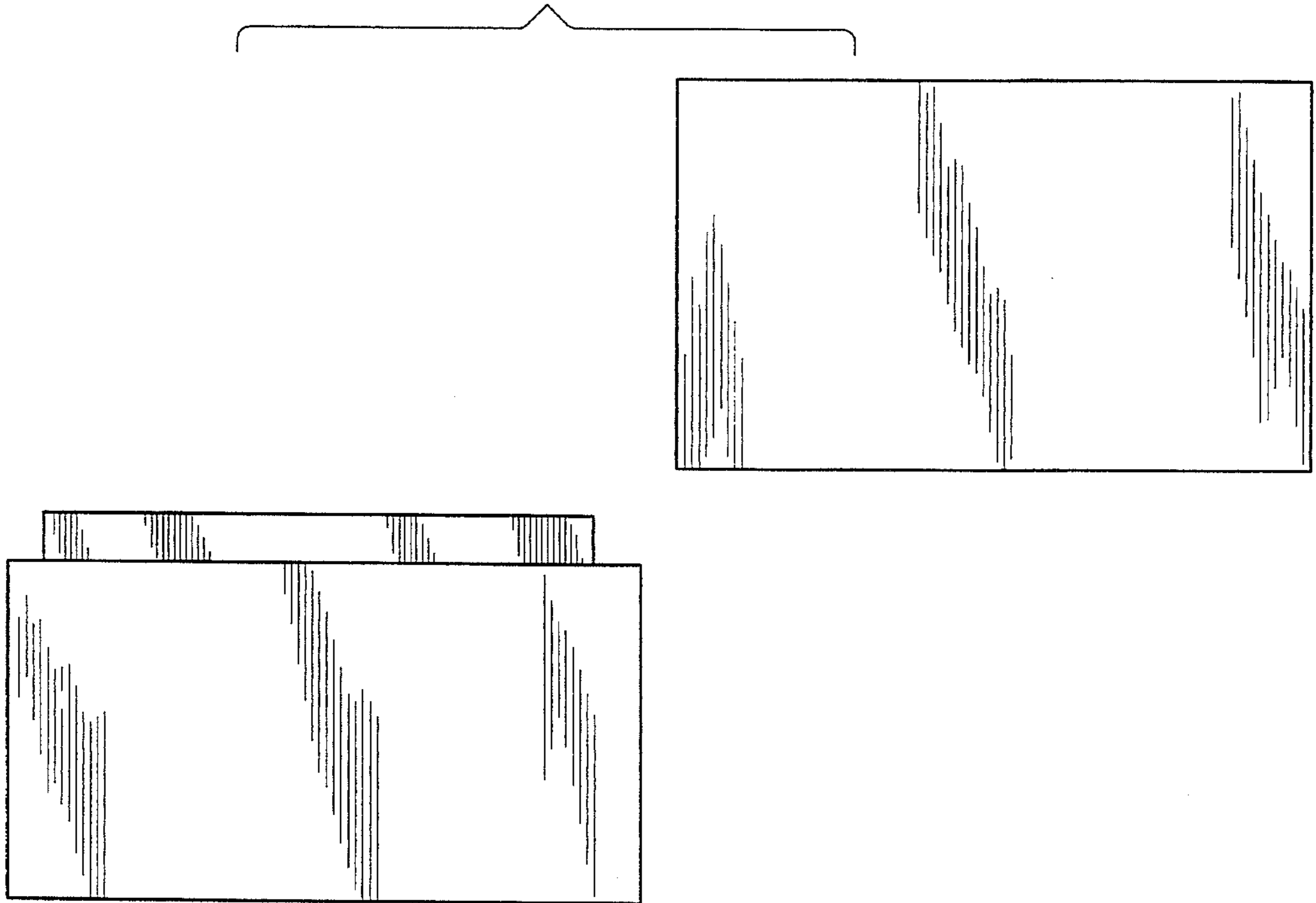

FIG. 2

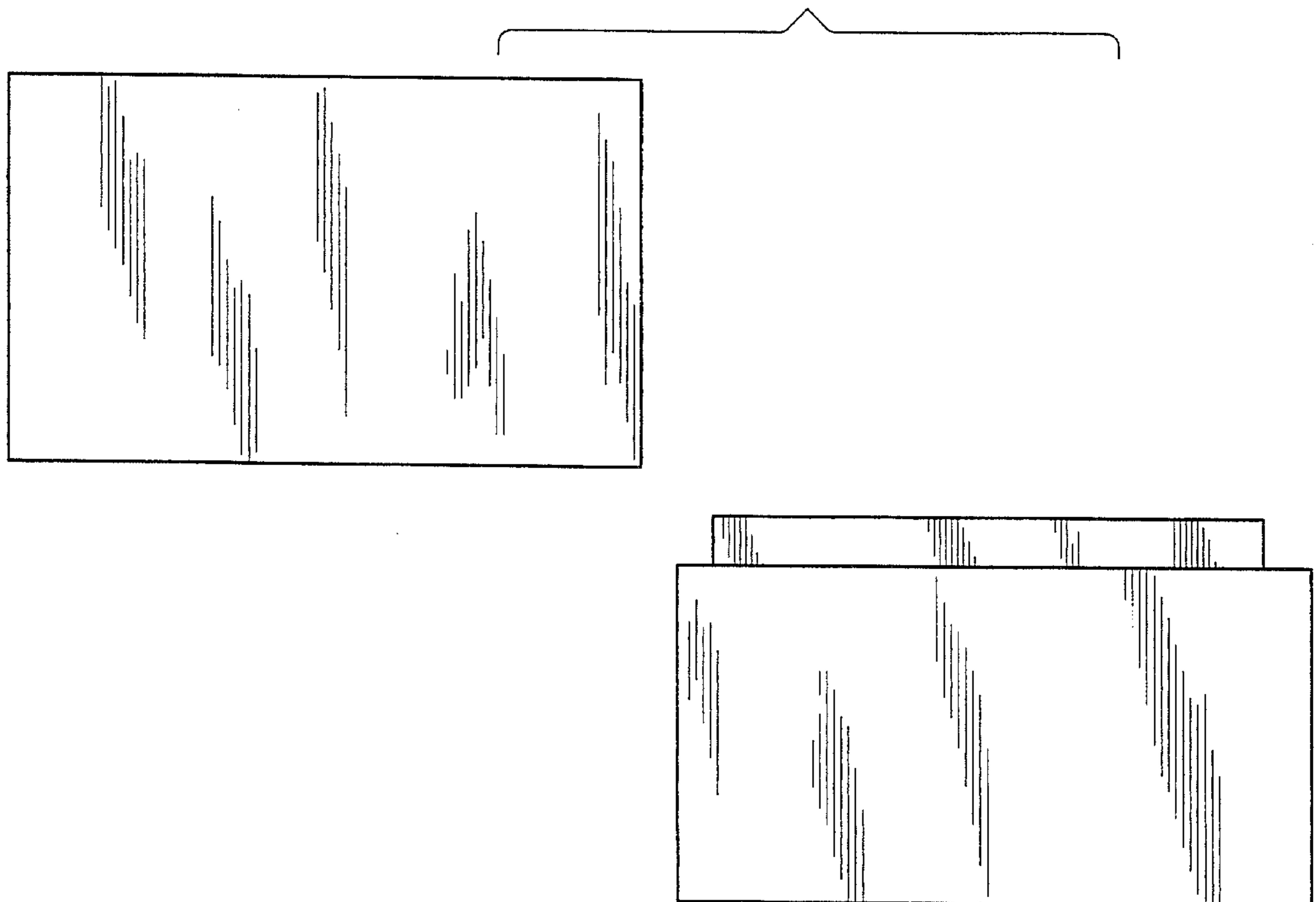

FIG. 3

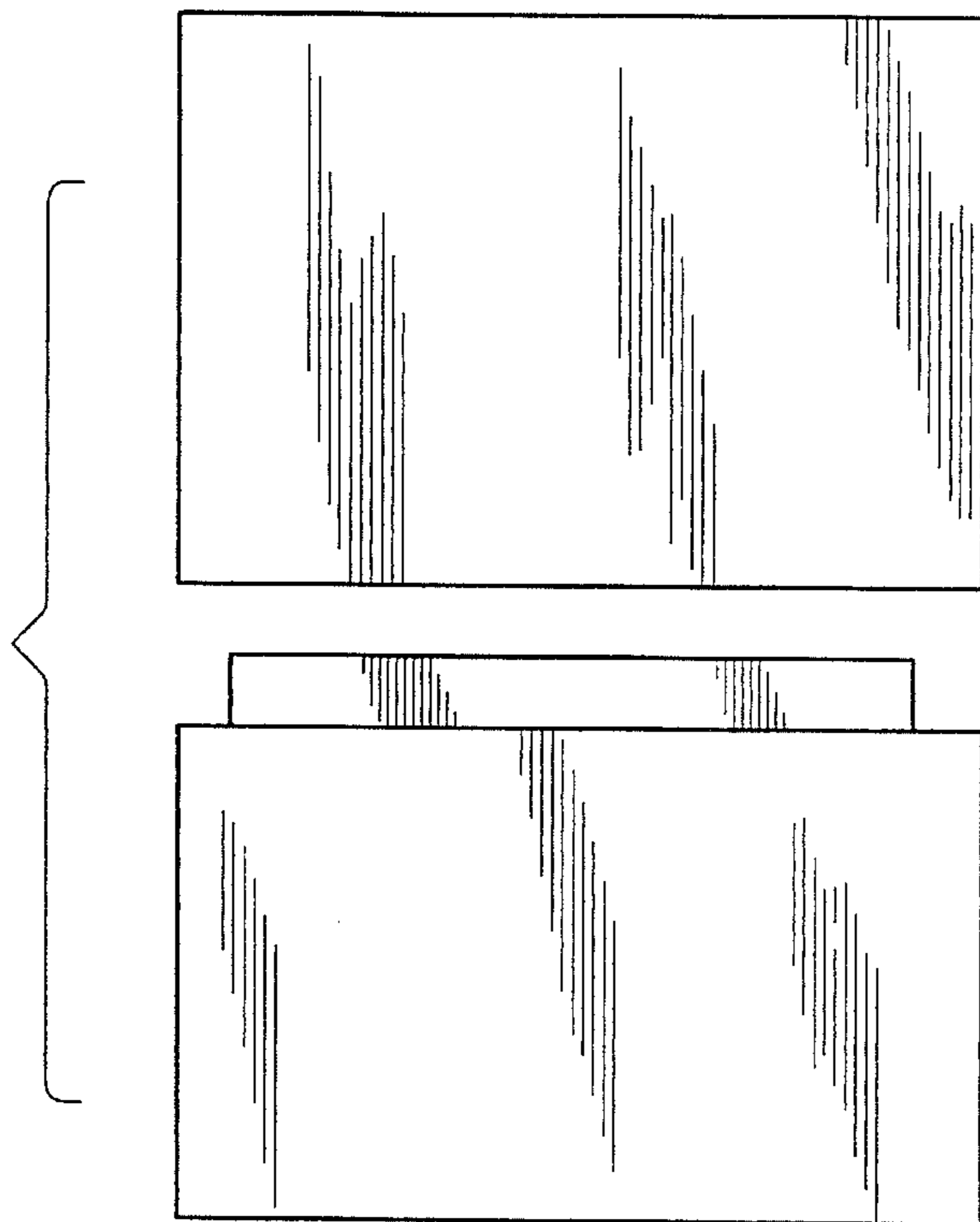

FIG. 4

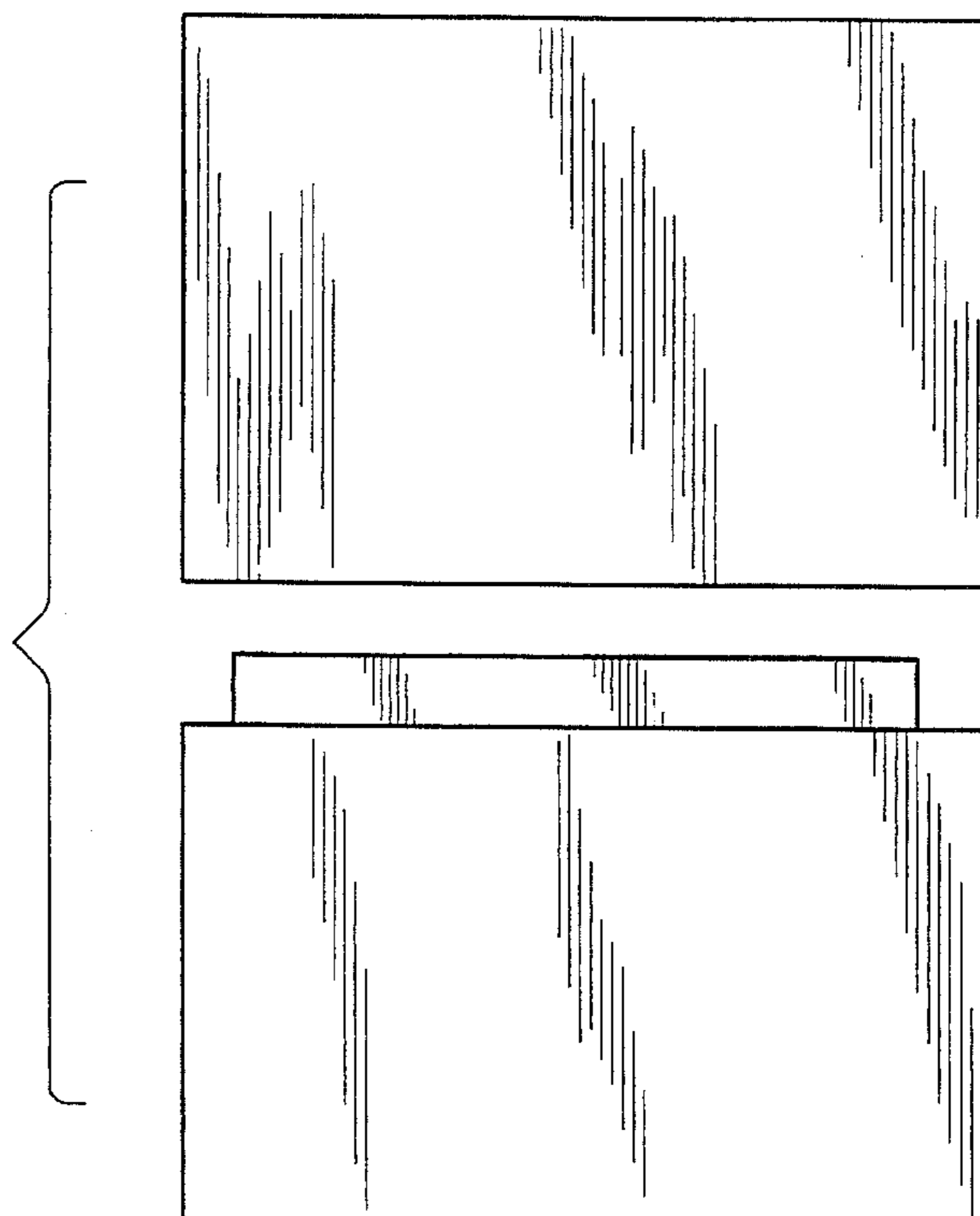

FIG. 5

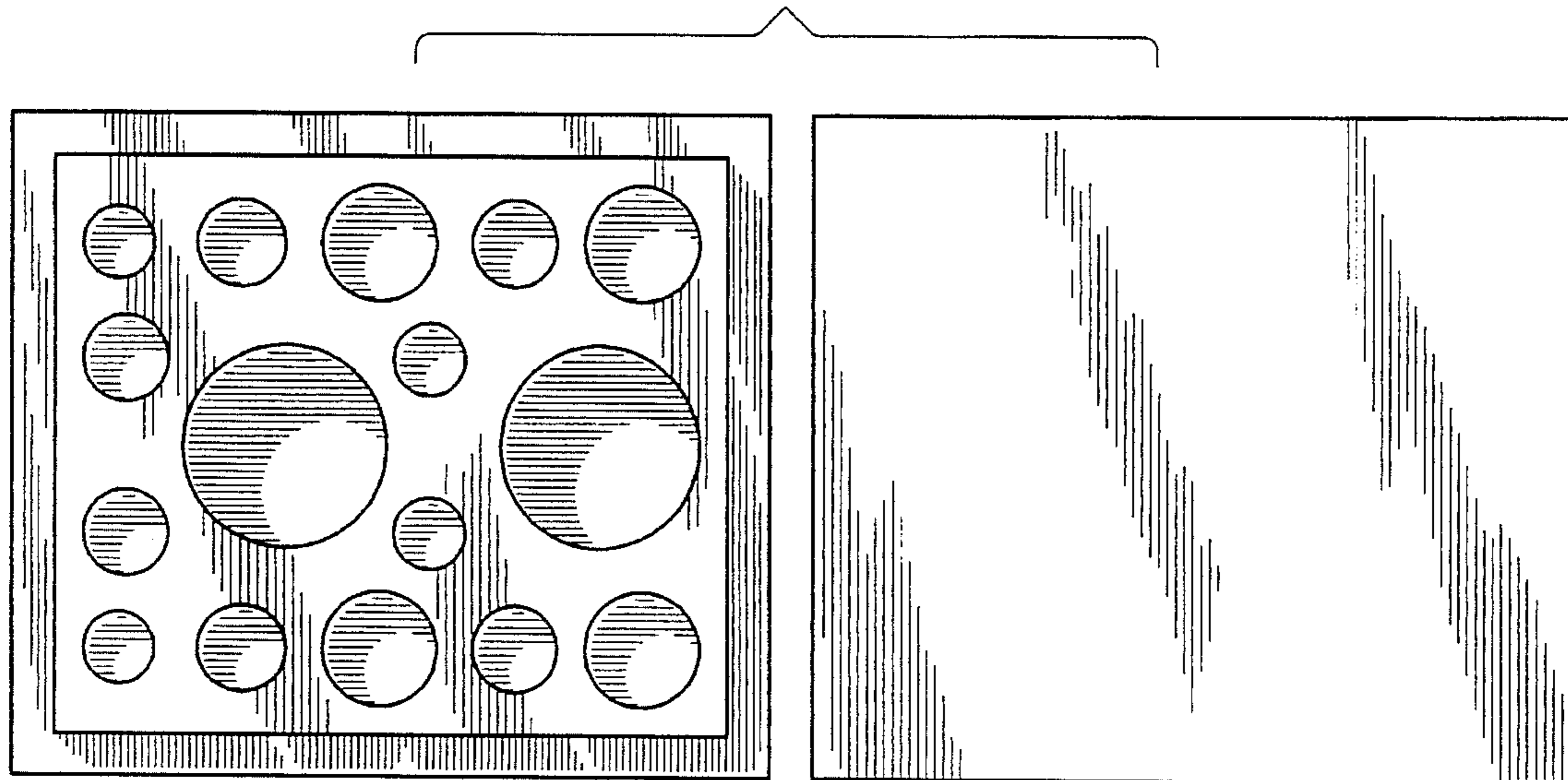

FIG. 6

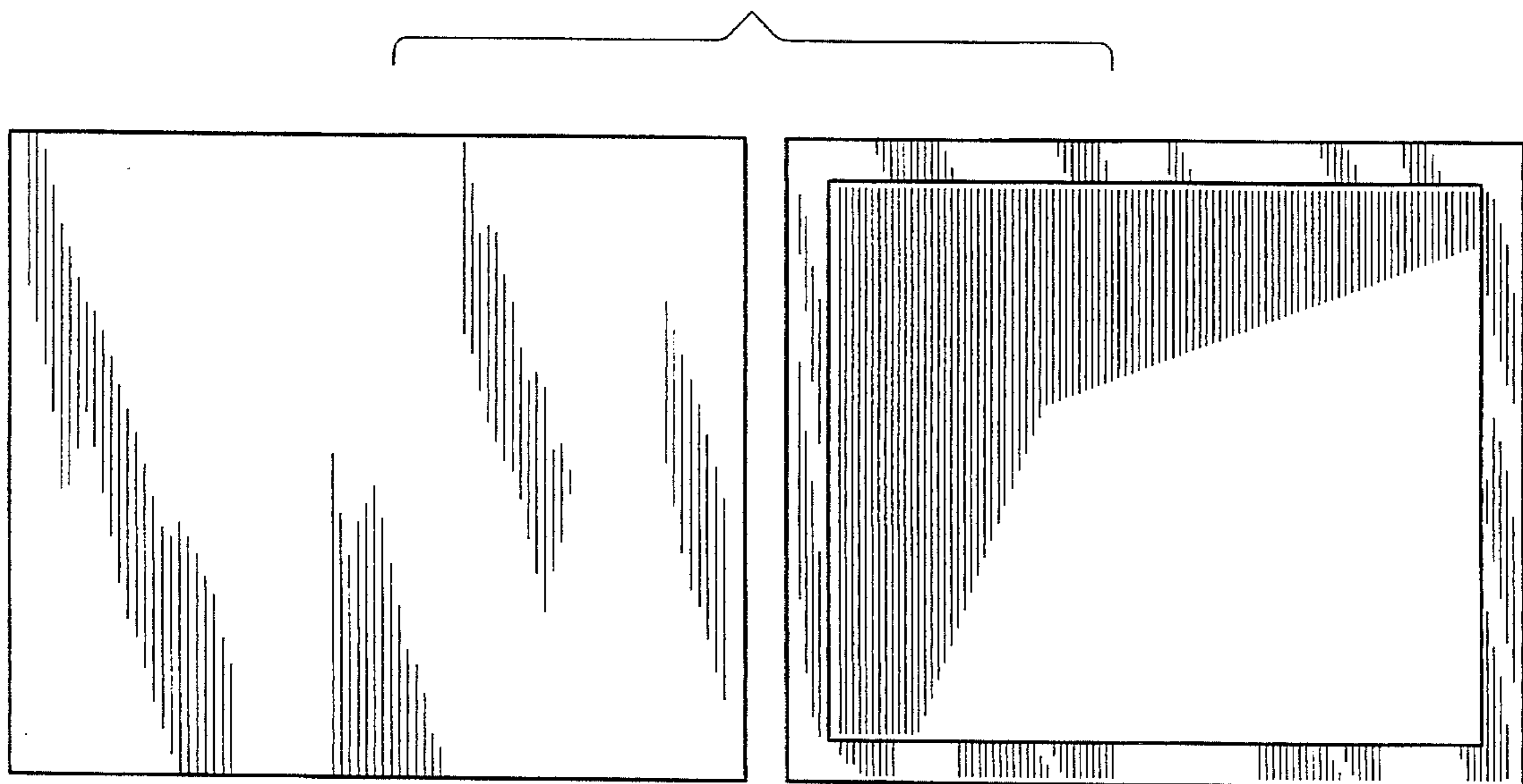

FIG. 7

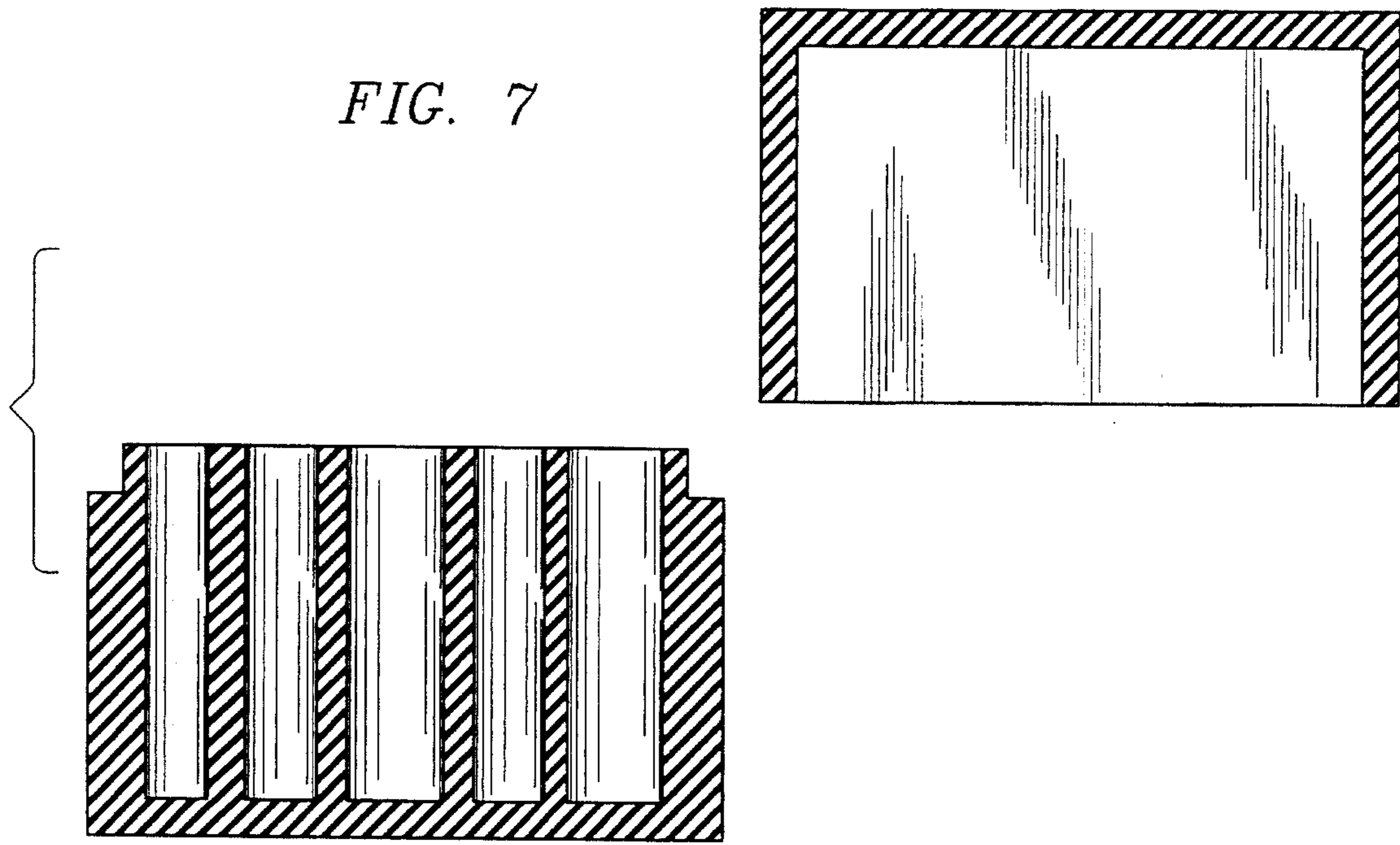

FIG. 8

