



US00D372111S

United States Patent [19] Zeigler

[11] Patent Number: **Des. 372,111**

[45] Date of Patent: ****Jul. 30, 1996**

[54] **COMBINED GLOVE AND SANDPAPER**

4,843,650 7/1989 Kangas et al. 2/159

[76] Inventor: **Karla M. Zeigler**, Rte. 6 Box 492,
Havana, Fla. 32333

FOREIGN PATENT DOCUMENTS

8100 of 1899 United Kingdom 2/159

[**] Term: **14 Years**

Primary Examiner—Paula A. Mortimer
Attorney, Agent, or Firm—Harold H. Dutton, Jr.; William C.
L. Jamison; Diane F. Liebman

[21] Appl. No.: **28,660**

[22] Filed: **Sep. 19, 1994**

[57] CLAIM

[52] U.S. Cl. **D2/612**

The ornamental design for a combined glove and sandpaper,
as shown.

[58] Field of Search D2/610, 611, 612,
D2/613, 614, 615, 616, 617, 621; 2/159,
160, 161, 161.8, 162, 158; D8/90

DESCRIPTION

[56] References Cited

U.S. PATENT DOCUMENTS

792,662	6/1905	Liebenstein	2/162	X
1,922,095	8/1933	Jones	2/159	
2,438,611	3/1948	Lindfelt	2/162	
2,590,015	3/1952	Kennedy	2/162	
2,831,196	4/1958	Scheiber	2/159	X
3,119,118	1/1964	Beebe	D2/621	X
3,267,486	8/1966	Madnick	D2/621	X
4,270,228	6/1981	Gaiser	2/161.8	X
4,750,218	6/1988	Ziegler	2/159	

FIG. 1 is a front elevational view of a combined glove and sandpaper showing my new design;
FIG. 2 is a rear view thereof;
FIG. 3 is a front view thereof with a piece of sandpaper thereon;
FIG. 4 is a rear view thereof with a piece of sandpaper thereon;
FIG. 5 is a right side view thereof;
FIG. 6 is a left side view thereof; and,
FIG. 7 is an exploded perspective view thereof.

1 Claim, 4 Drawing Sheets

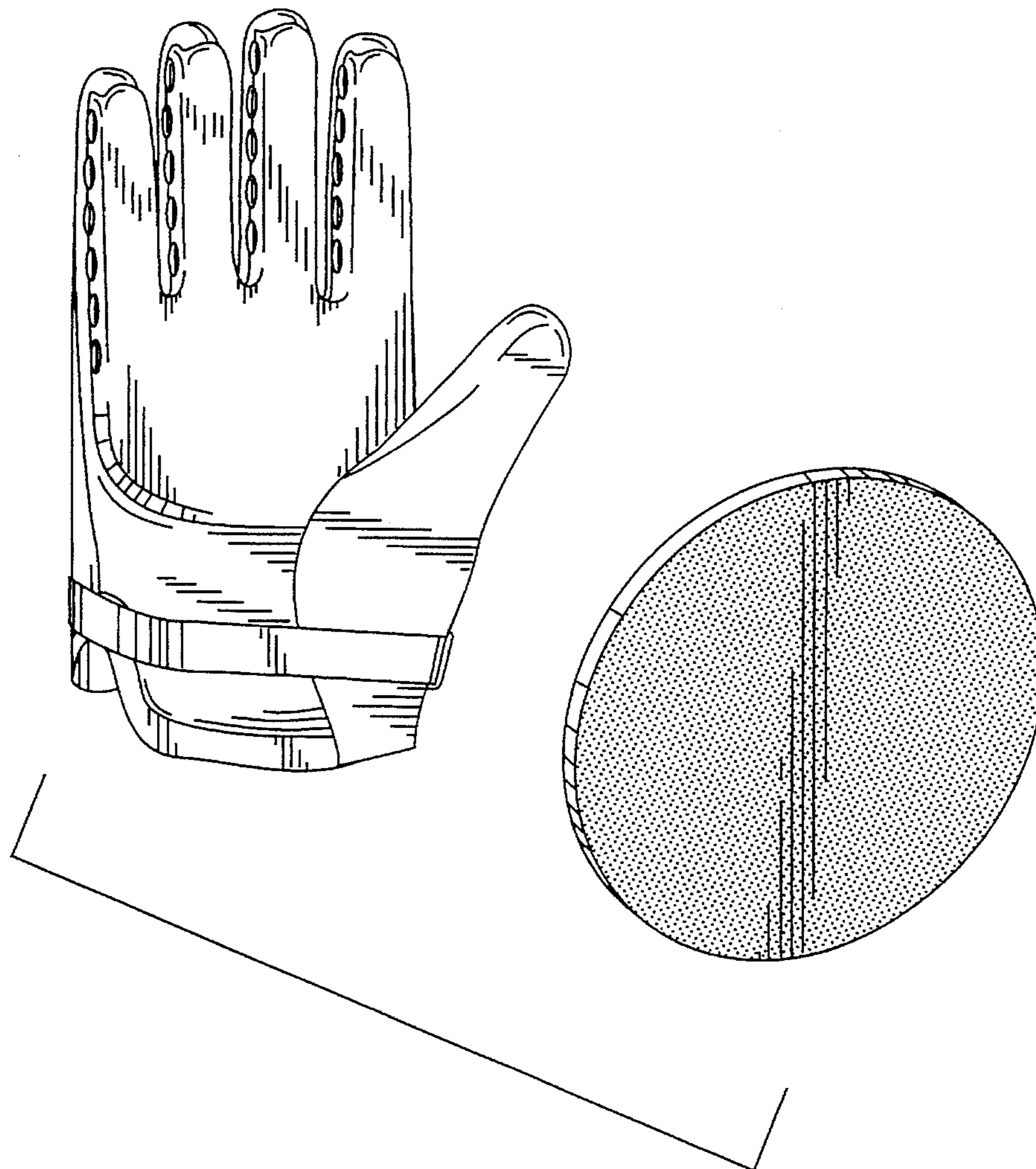

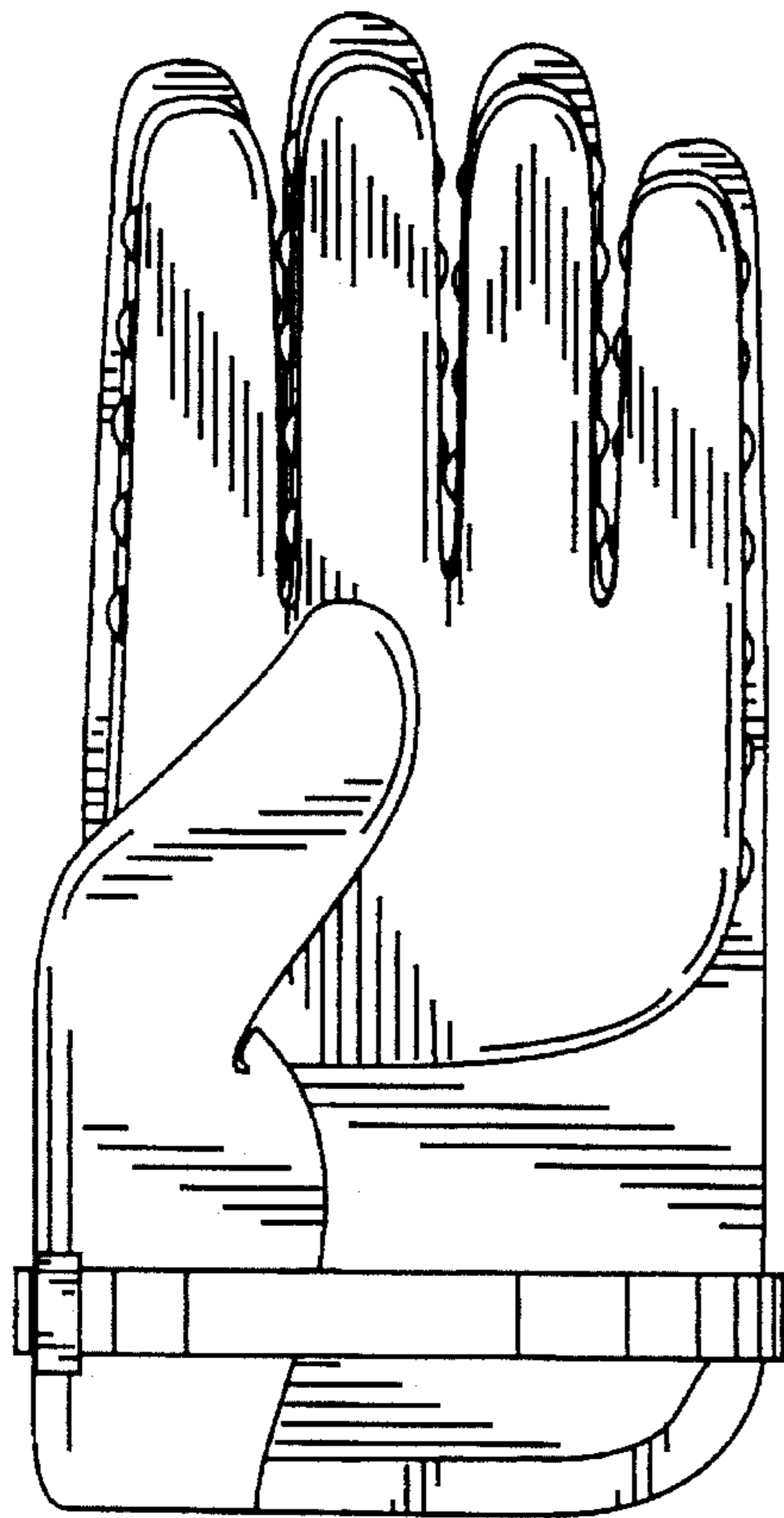

FIG. 1

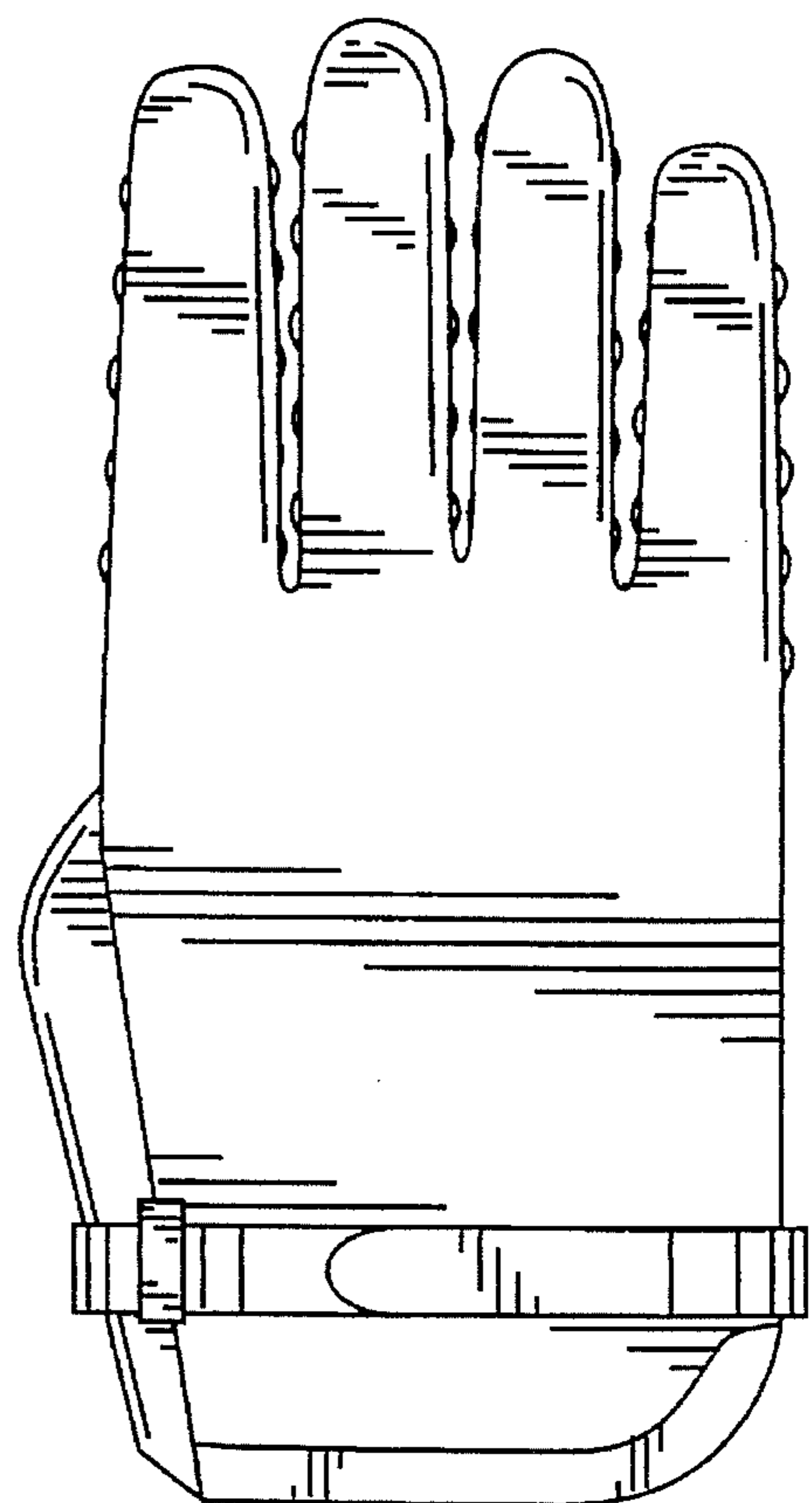

FIG. 2

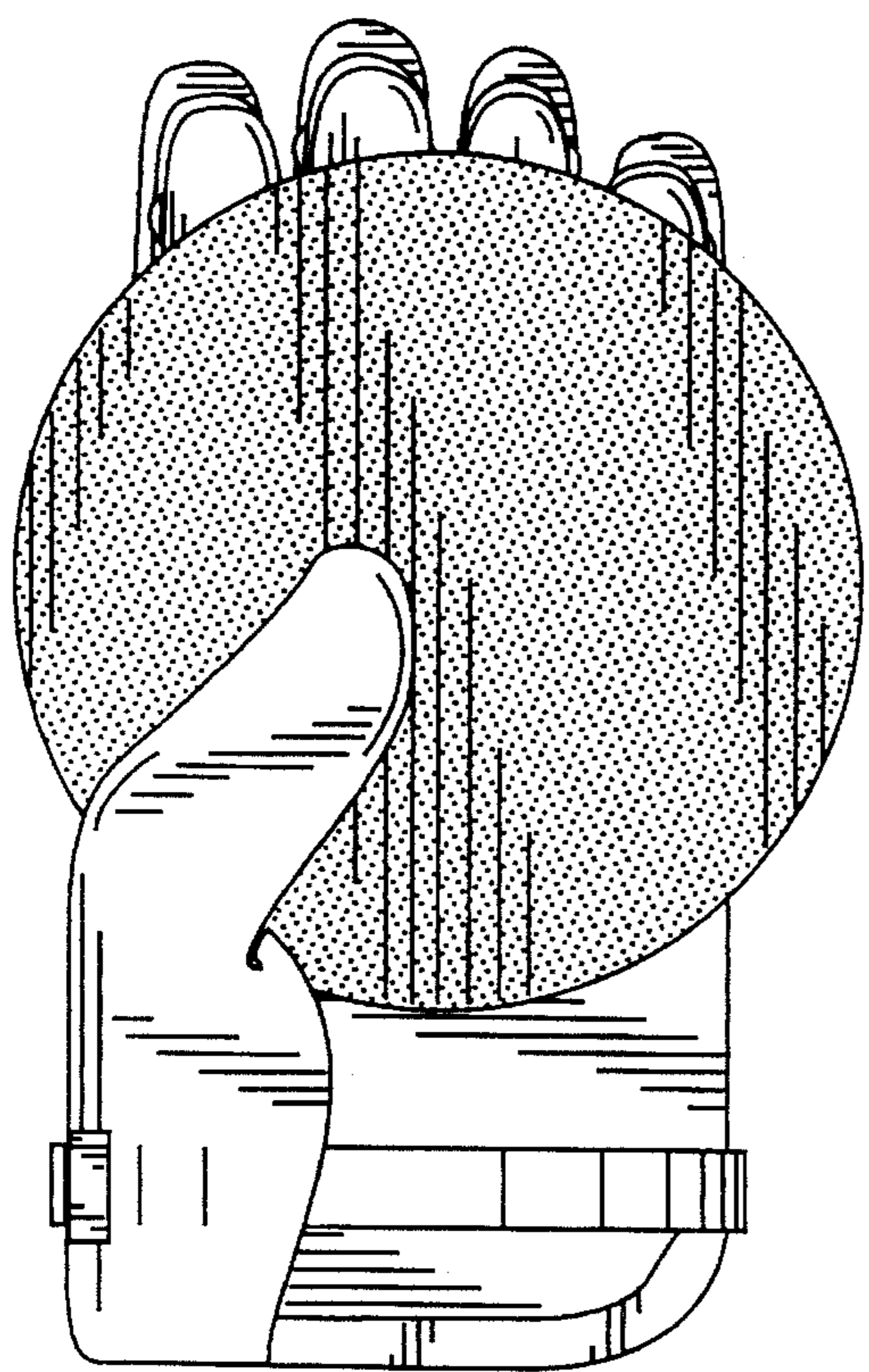

FIG. 3

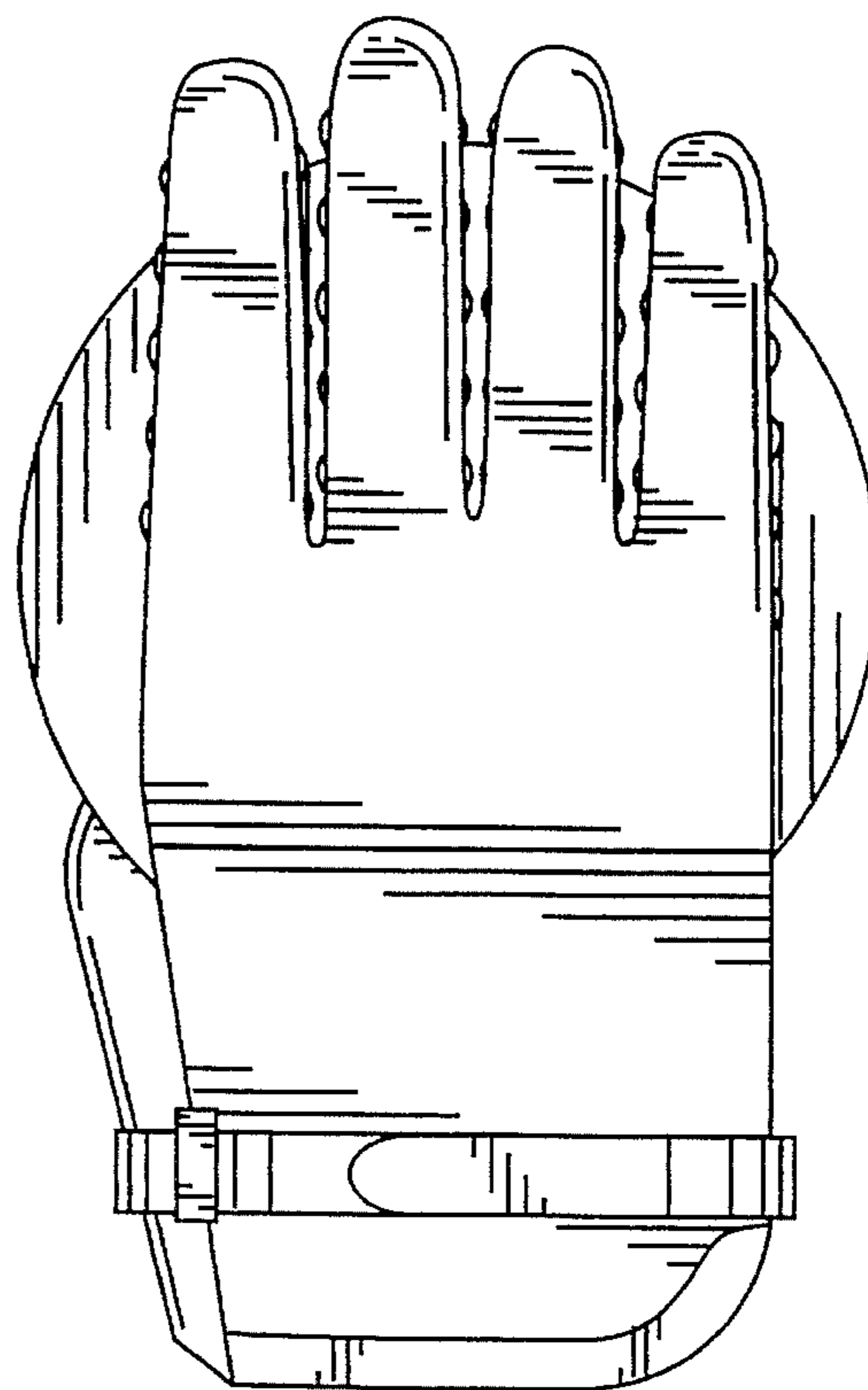

FIG. 4

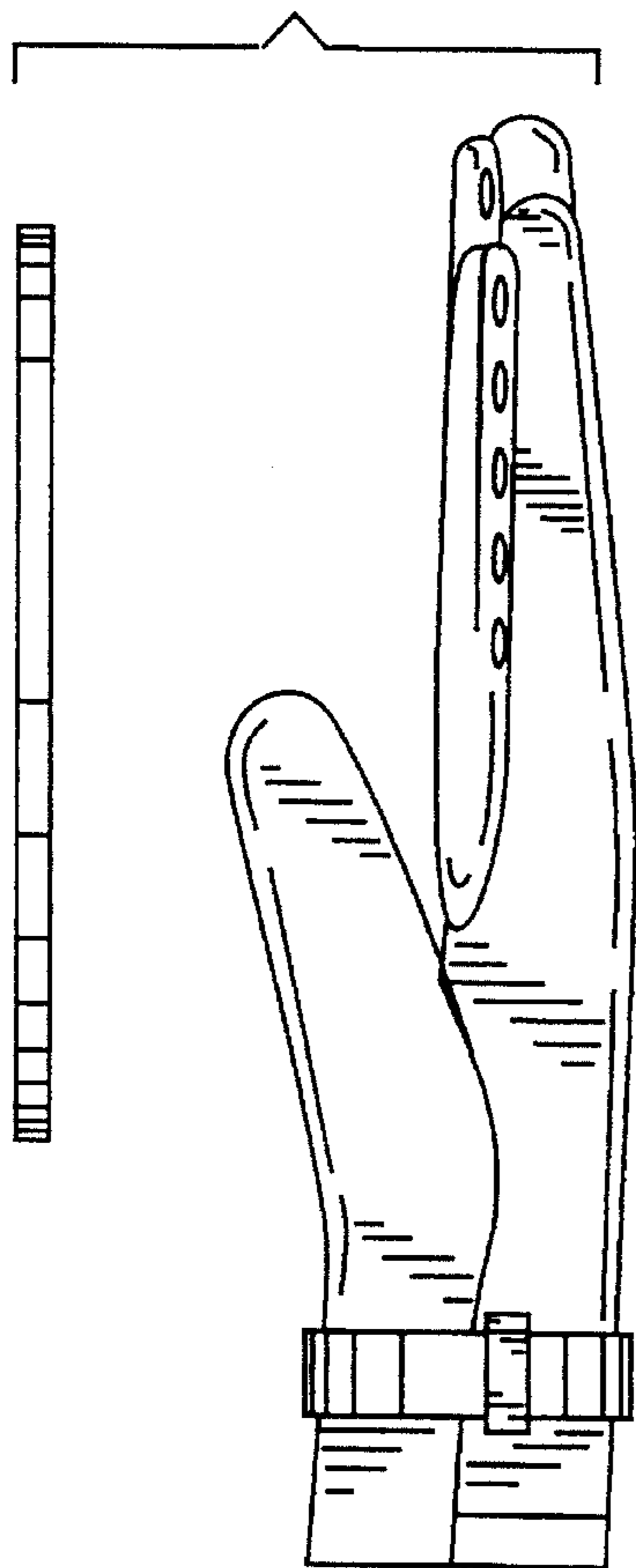

FIG. 5

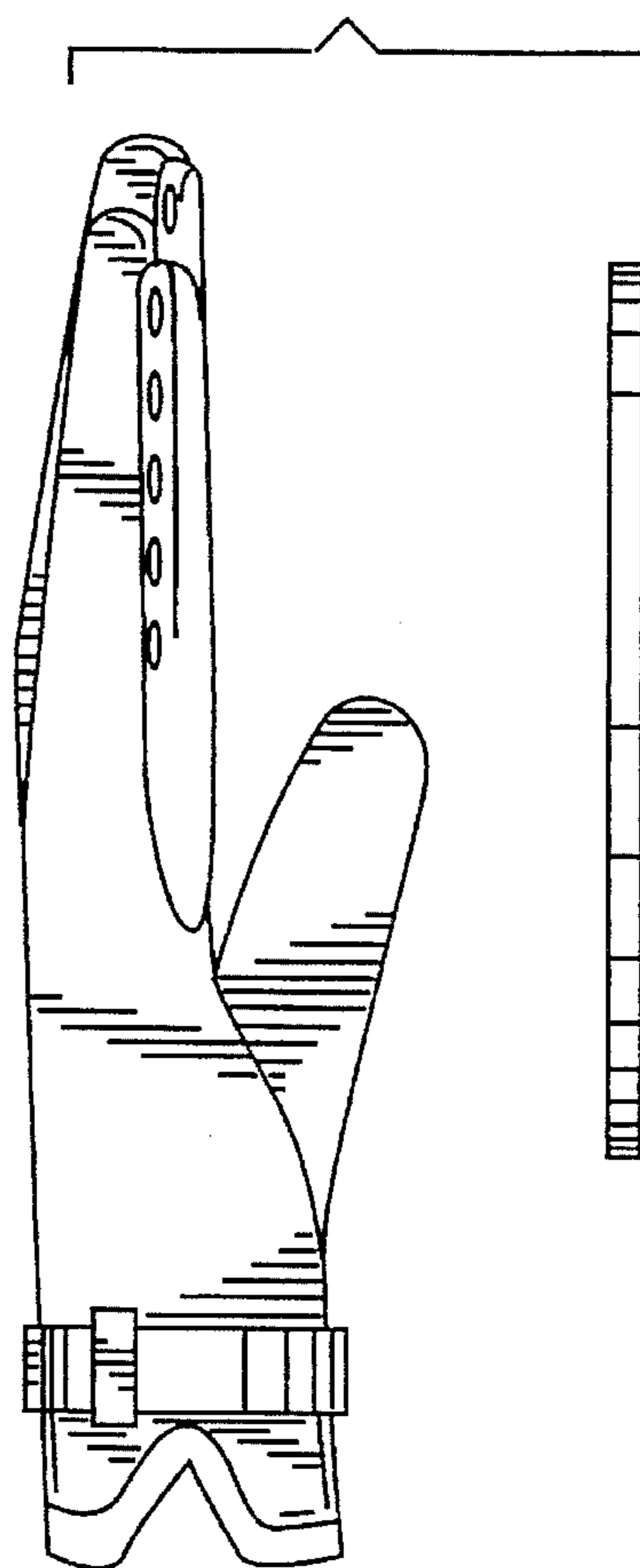

FIG. 6

