



US00D372057S

United States Patent [19] Yang

[11] Patent Number: **Des. 372,057**

[45] Date of Patent: ****Jul. 23, 1996**

[54] TOY TOASTER

[76] Inventor: **Chin-Long Yang**, No. 48, Lane 502,
Wen Shyan Rd., Tainan, Taiwan

[**] Term: **14 Years**

[21] Appl. No.: **37,414**

[22] Filed: **Apr. 12, 1995**

[52] U.S. Cl. **D21/122; D7/330**

[58] Field of Search **D21/122; D7/350,
D7/351, 328, 329, 330; 446/481, 408, 143;
99/327, 335, 385, 389, 391**

[56] References Cited

U.S. PATENT DOCUMENTS

D. 266,732	11/1982	Kelley	D7/330
D. 304,661	11/1989	Van Asten	D7/330
D. 328,833	8/1992	Myers et al.	D7/330
D. 337,476	7/1993	Raab	D7/330
D. 338,368	8/1993	Naft et al.	D7/330
3,765,120	10/1973	Waak	446/481

OTHER PUBLICATIONS

Sears Wishbook 1991 p. 392, toaster at bottom of page.

Primary Examiner—Raphael Barkai

Attorney, Agent, or Firm—Morton J. Rosenberg; David I. Klein

[57] CLAIM

The ornamental design for a toy toaster, as shown and described.

DESCRIPTION

FIG. 1 is a perspective view of a toy toaster showing my present design;

FIG. 2 is a front view thereof;

FIG. 3 is a rear view thereof;

FIG. 4 is a left view thereof;

FIG. 5 is a right view thereof;

FIG. 6 is a top plan view thereof; and,

FIG. 7 is a bottom plan view.

1 Claim, 5 Drawing Sheets

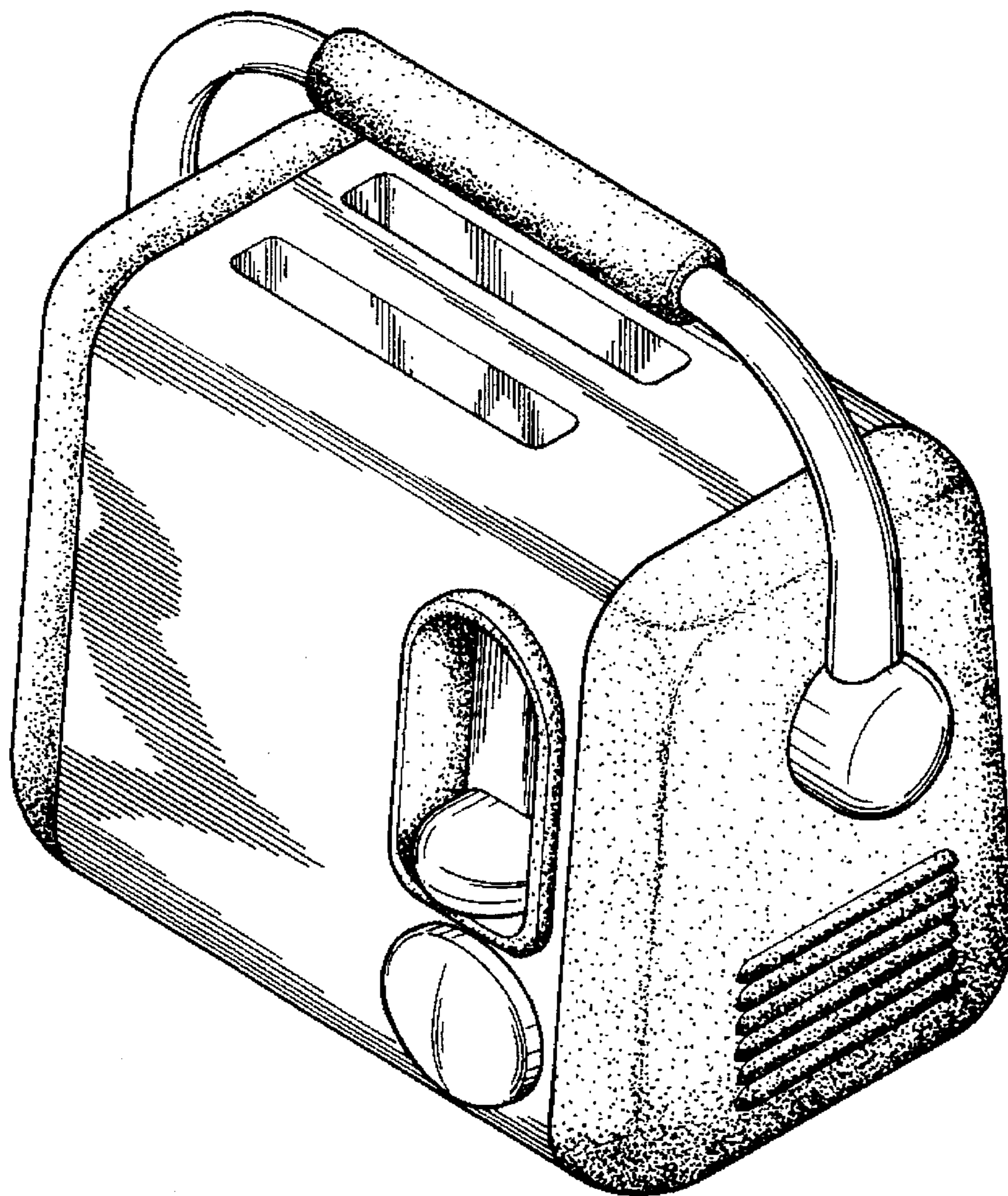

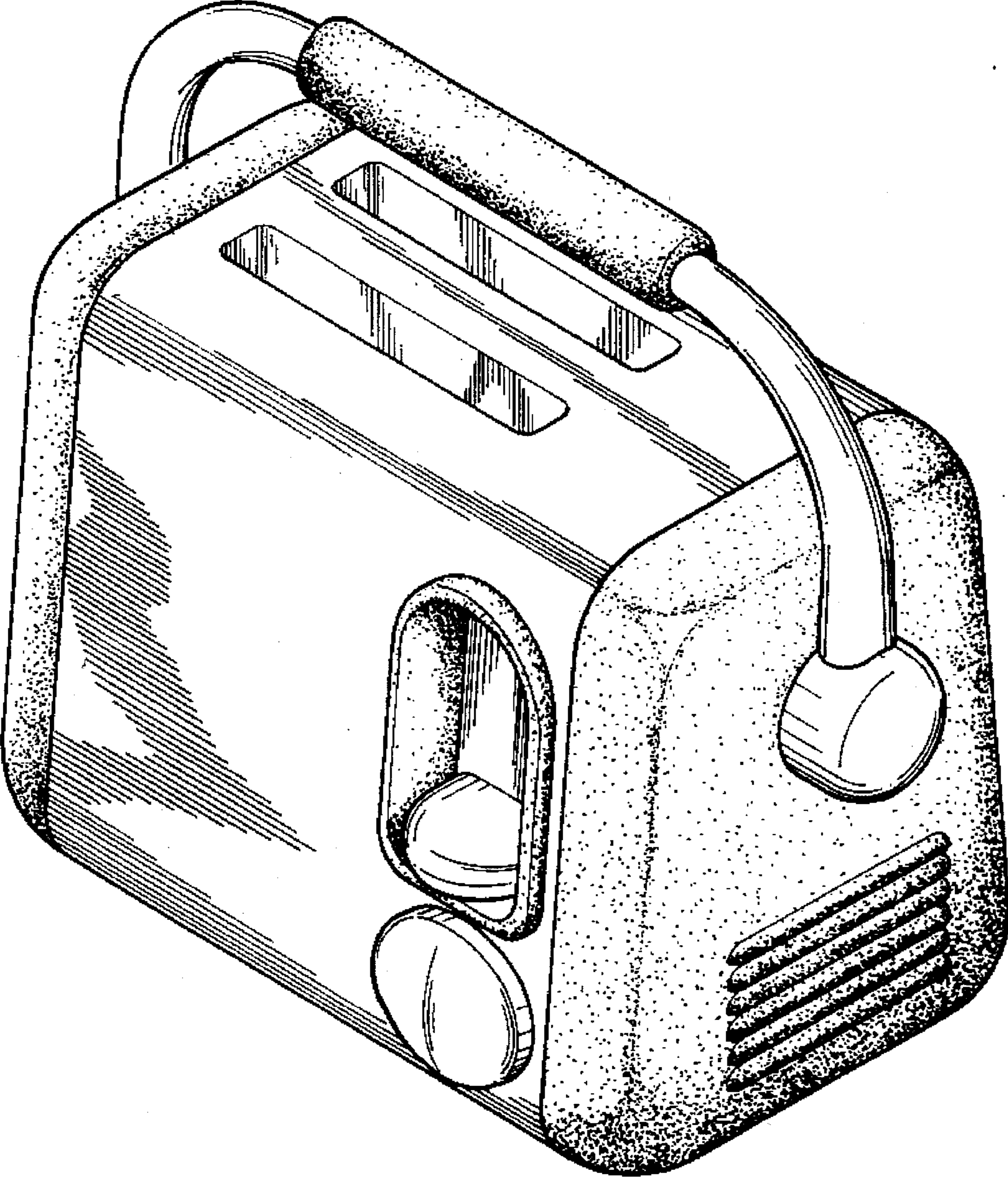

FIG. 1

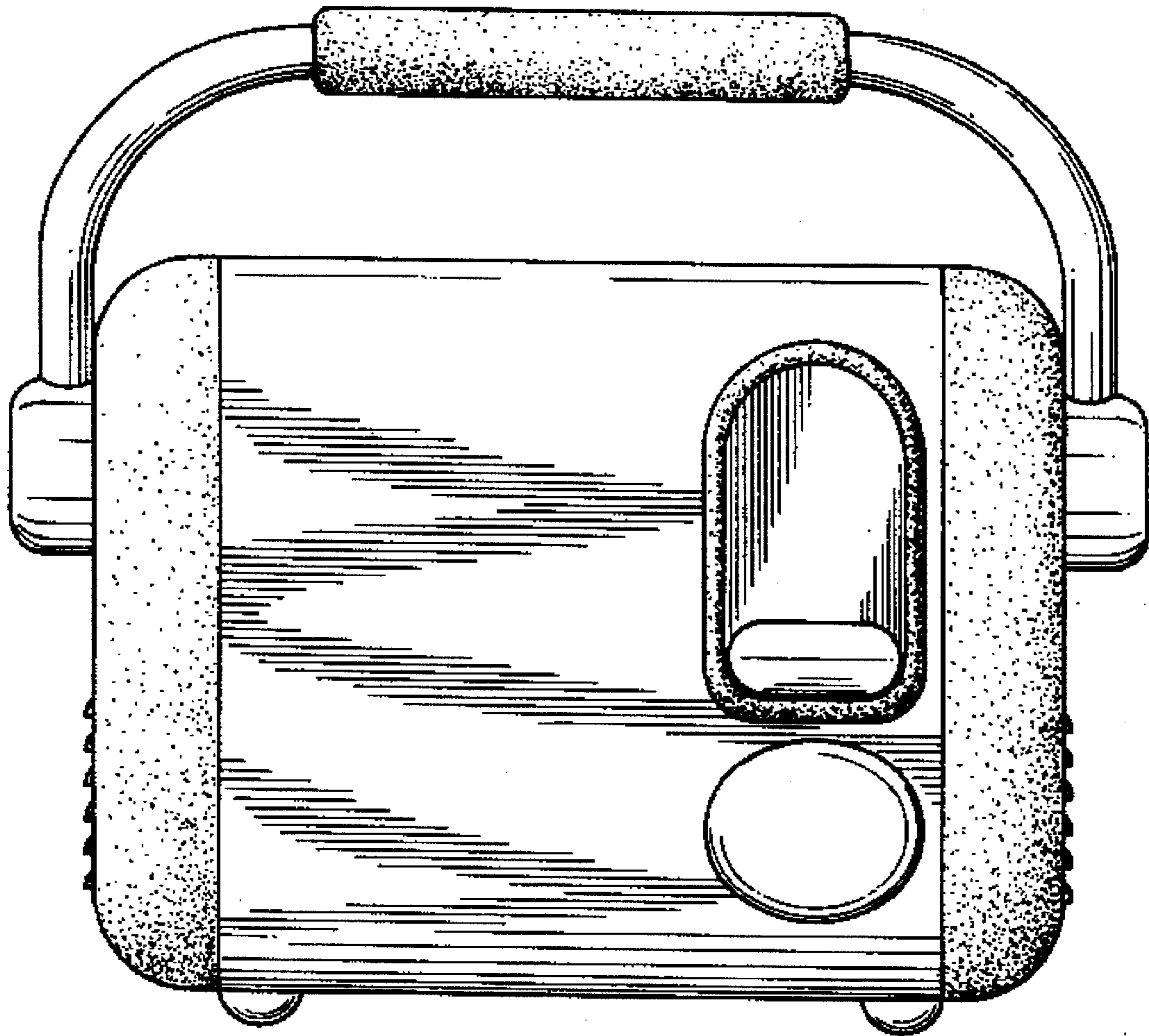

FIG. 2

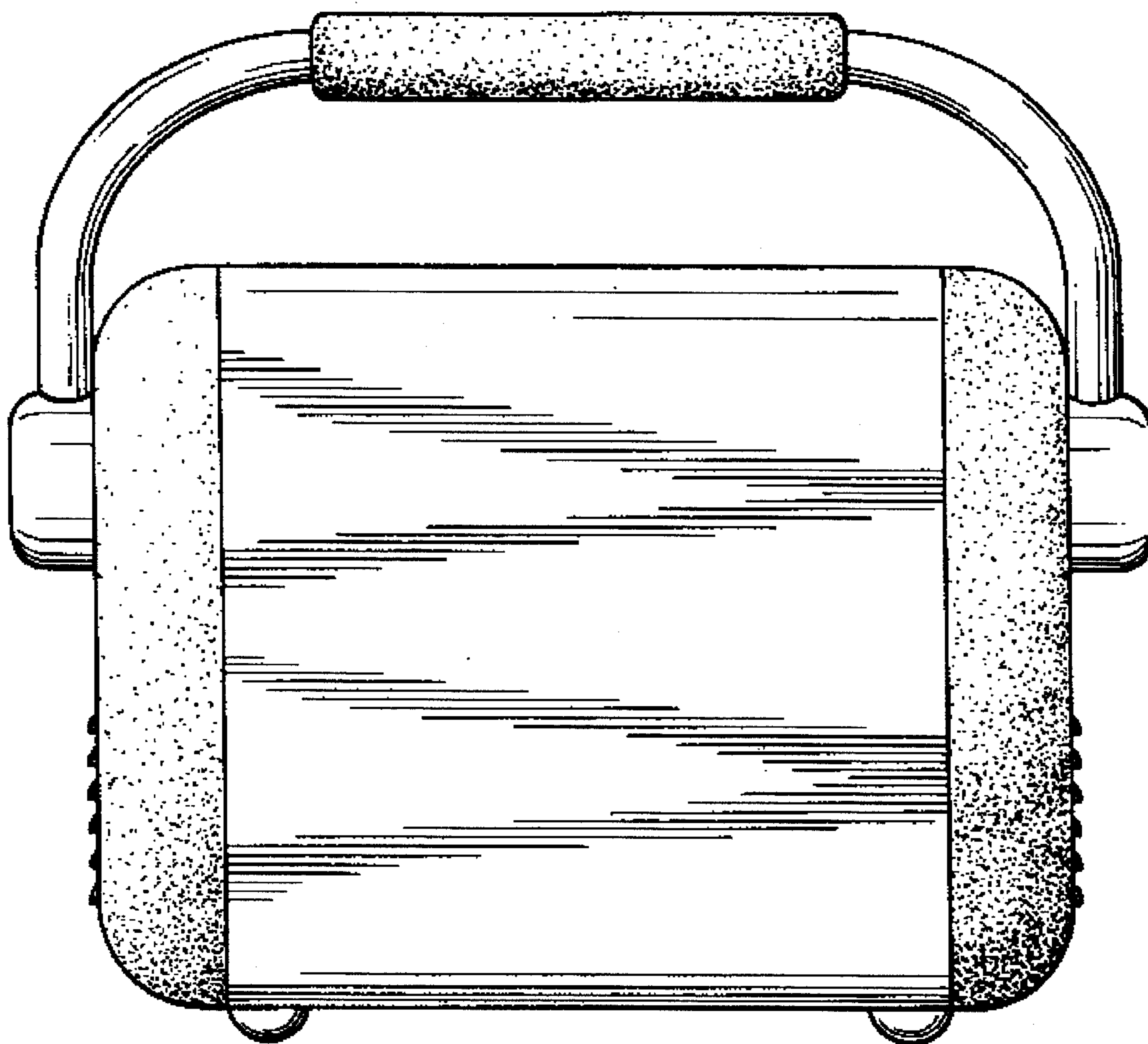

FIG. 3

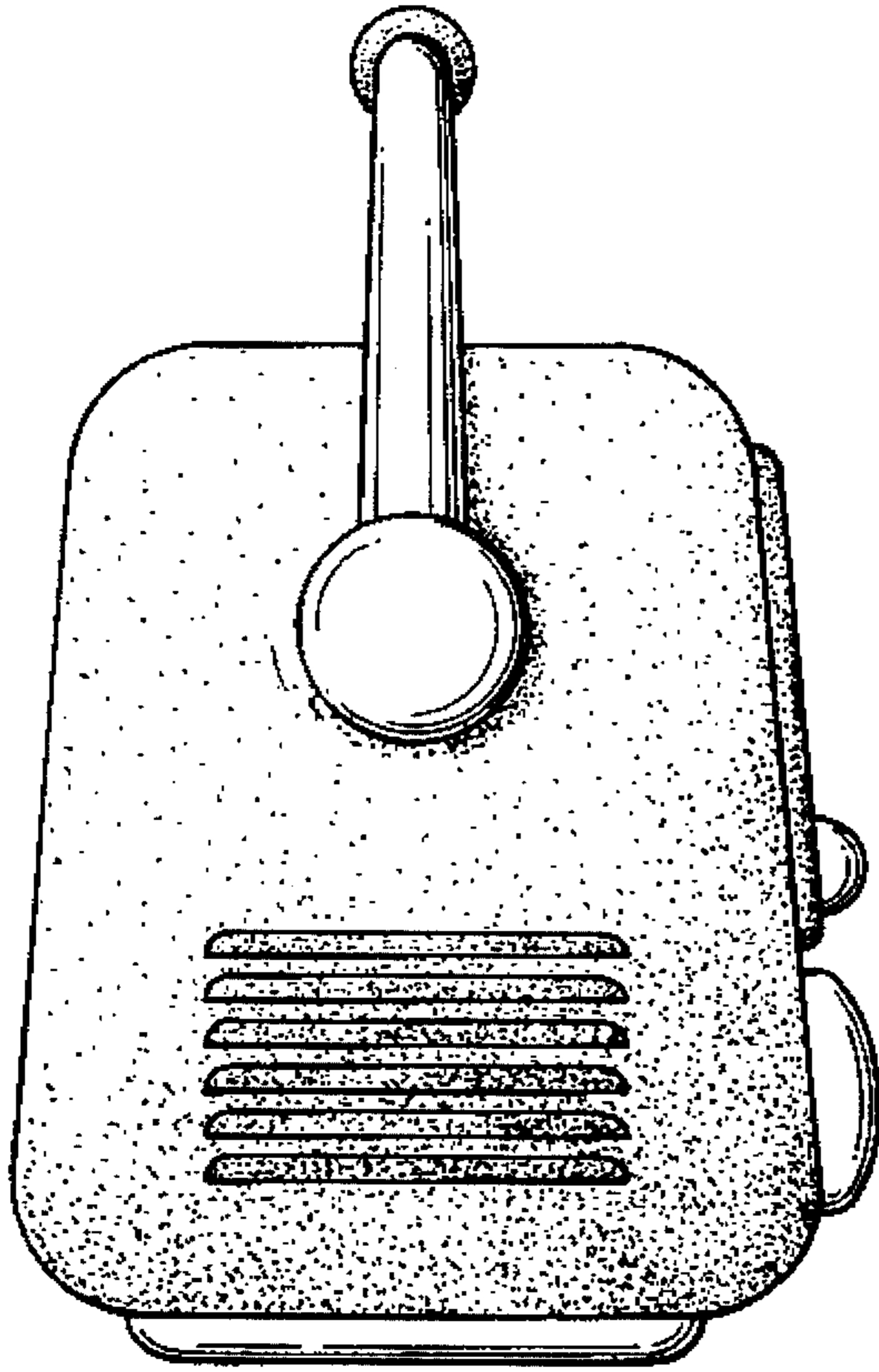

FIG. 4

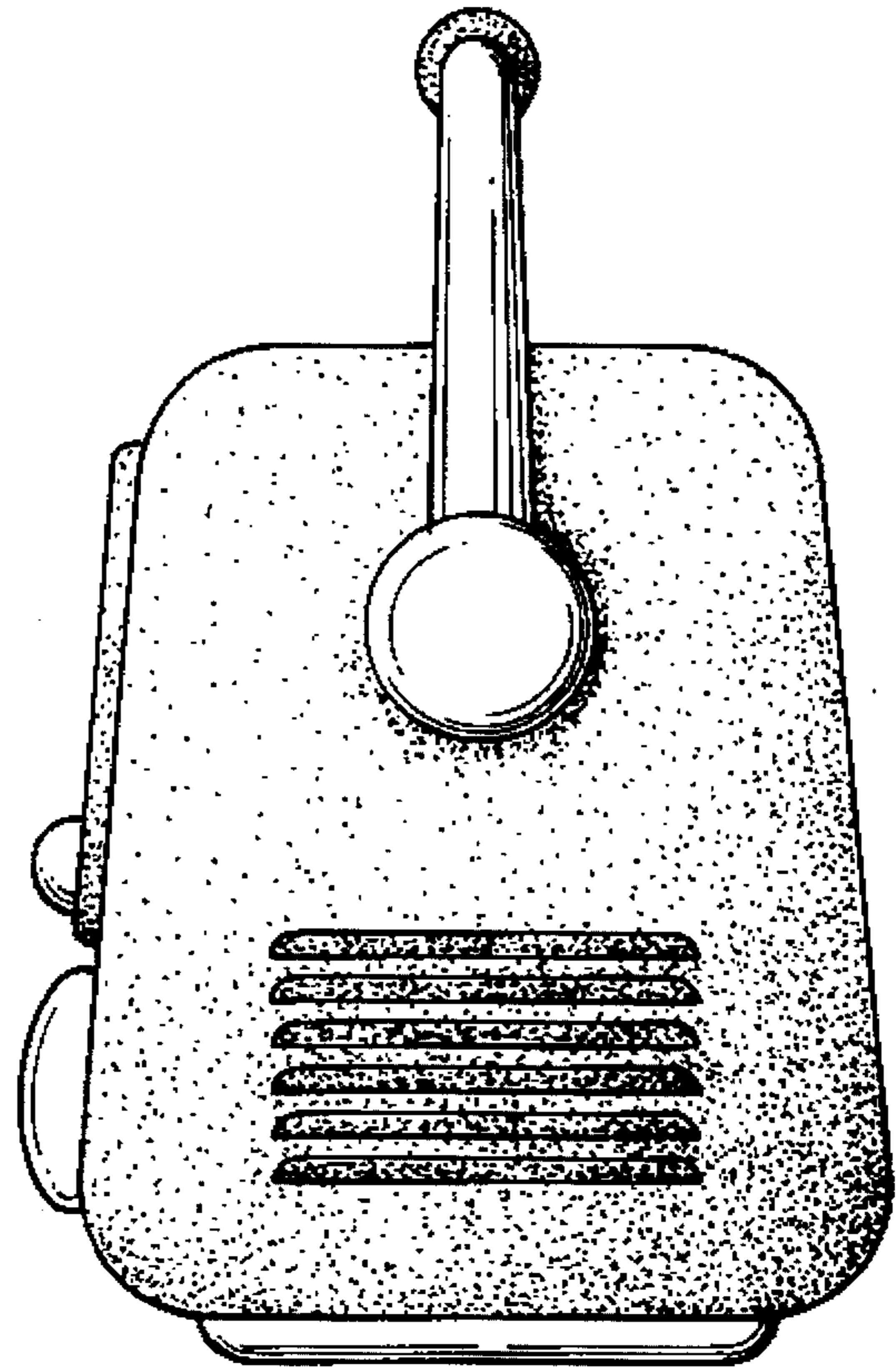

FIG. 5

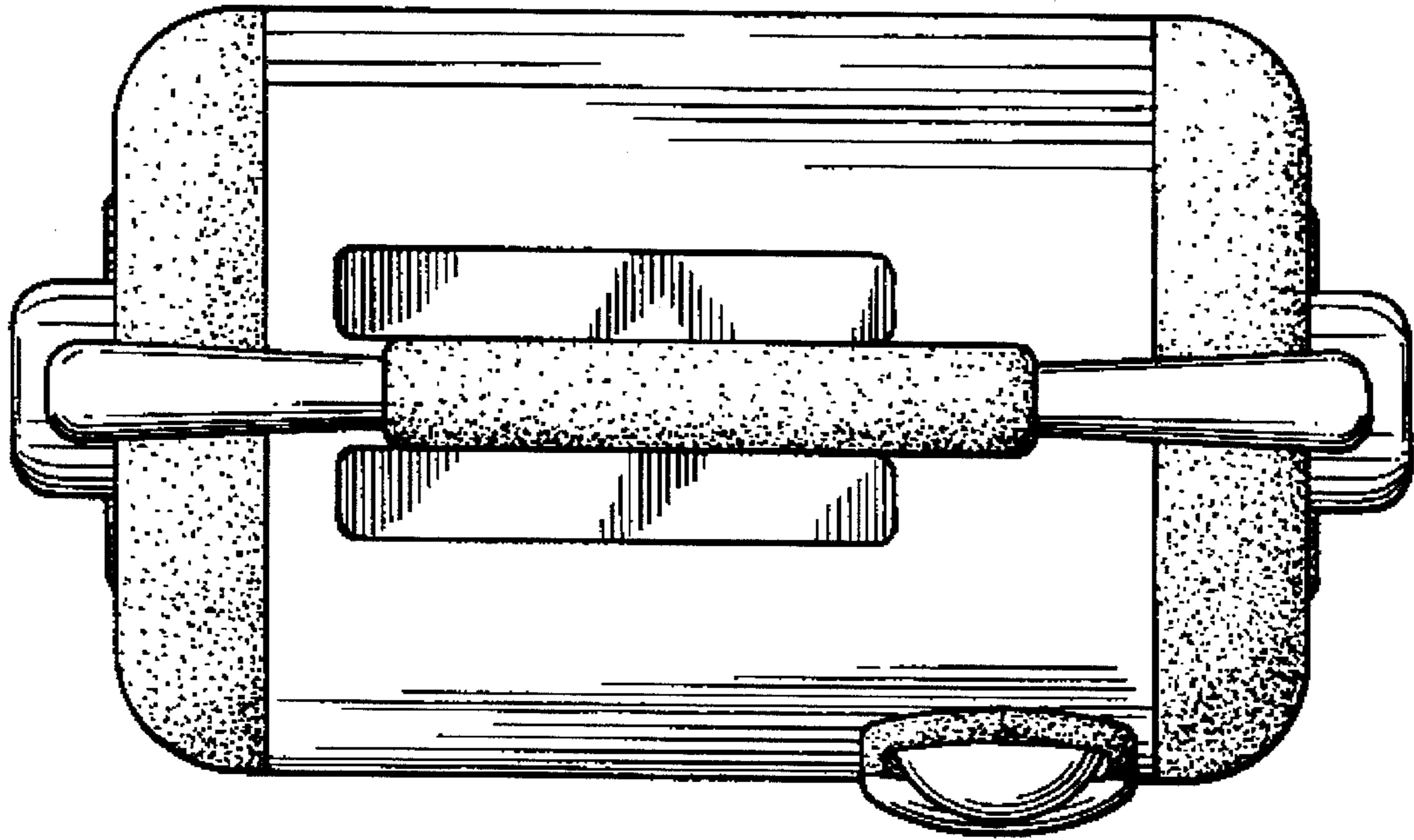

FIG. 6

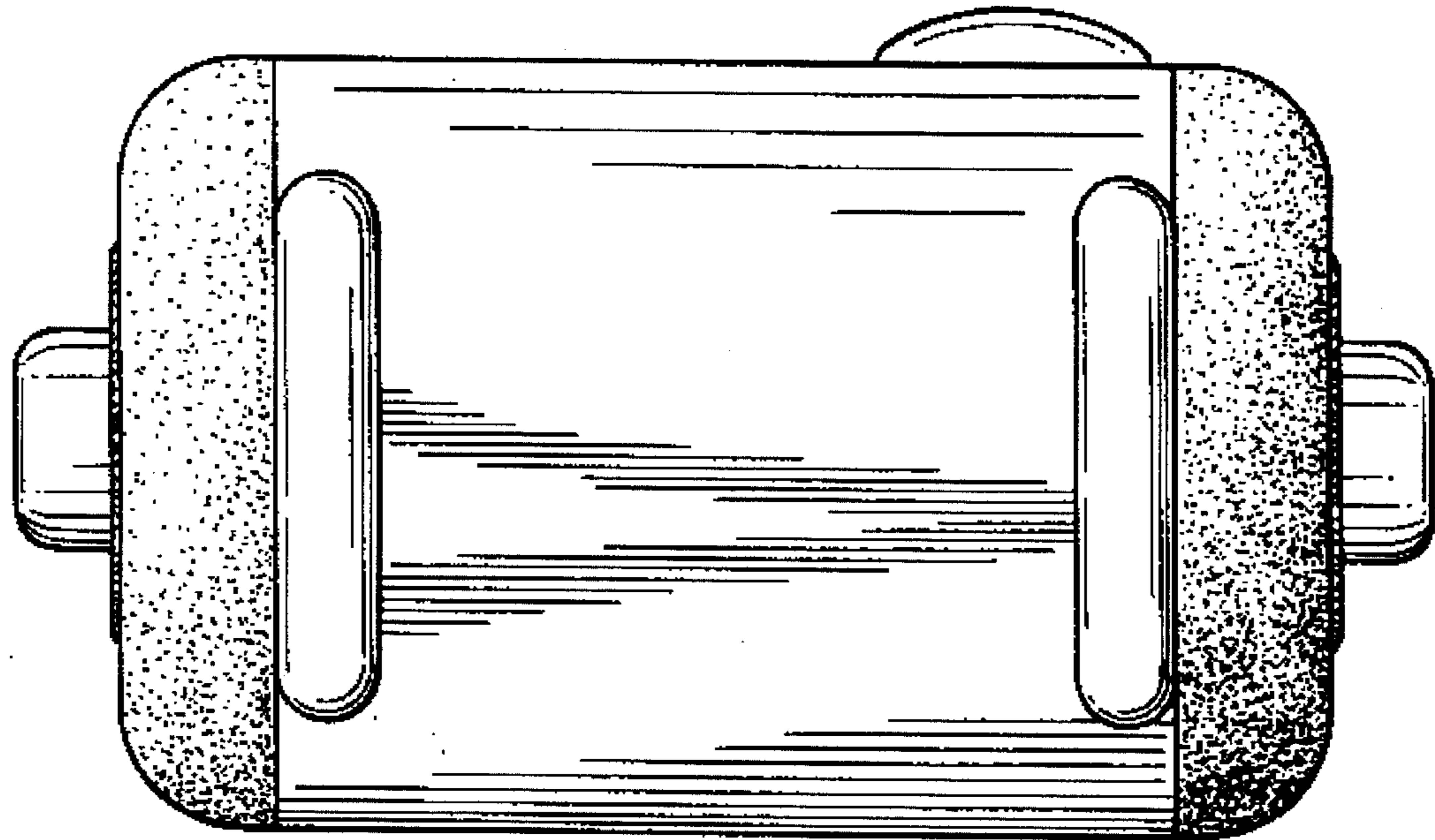

FIG. 7