



US00D372025S

United States Patent [19] Mo

[11] Patent Number: **Des. 372,025**

[45] Date of Patent: ****Jul. 23, 1996**

[54] TELEPHONE

[75] Inventor: **Michael Mo**, Taipei Hsien, Taiwan

[73] Assignee: **Dialer & Business Electronic Co., Ltd.**, Taipei Hsien, Taiwan

[**] Term: **14 Years**

[21] Appl. No.: **43,474**

[22] Filed: **Aug. 29, 1995**

[52] U.S. Cl. **D14/151**

[58] Field of Search D14/140, 142,
D14/149-151, 240, 241, 147, 148, 137,
138, 101; 379/419, 420, 428, 440, 434-436,
454, 455; D21/111

[56] **References Cited**

U.S. PATENT DOCUMENTS

D. 255,680	7/1980	Read et al.	D14/151
D. 293,318	12/1987	Rhodes	D14/151
D. 300,319	3/1989	Stokholm et al.	D14/151
D. 307,429	4/1990	Pfiefer et al.	D14/151
D. 320,985	10/1991	Danielson et al.	D14/142 X
D. 320,987	10/1991	Grinyer	D14/151

D. 338,670	8/1993	Egipciaco	D14/149
D. 345,975	4/1994	Biskup et al.	D14/149
5,131,034	7/1992	Read	379/435

OTHER PUBLICATIONS

B. A. Pargh Spring/Summer 1991, p. 307, Cobra Telephone 2nd from top at left.

Primary Examiner—Jeffrey Asch
Attorney, Agent, or Firm—Bacon & Thomas

[57] **CLAIM**

The ornamental design for a telephone, as shown and described.

DESCRIPTION

FIG. 1 is a perspective view of a telephone showing my new design;
FIG. 2 is a front elevational view thereof;
FIG. 3 is a rear elevational view thereof;
FIG. 4 is a side elevational view thereof;
FIG. 5 is an elevational view of the side opposite to FIG. 4;
FIG. 6 is a top plan view thereof; and,
FIG. 7 is a bottom plan view thereof.

1 Claim, 6 Drawing Sheets

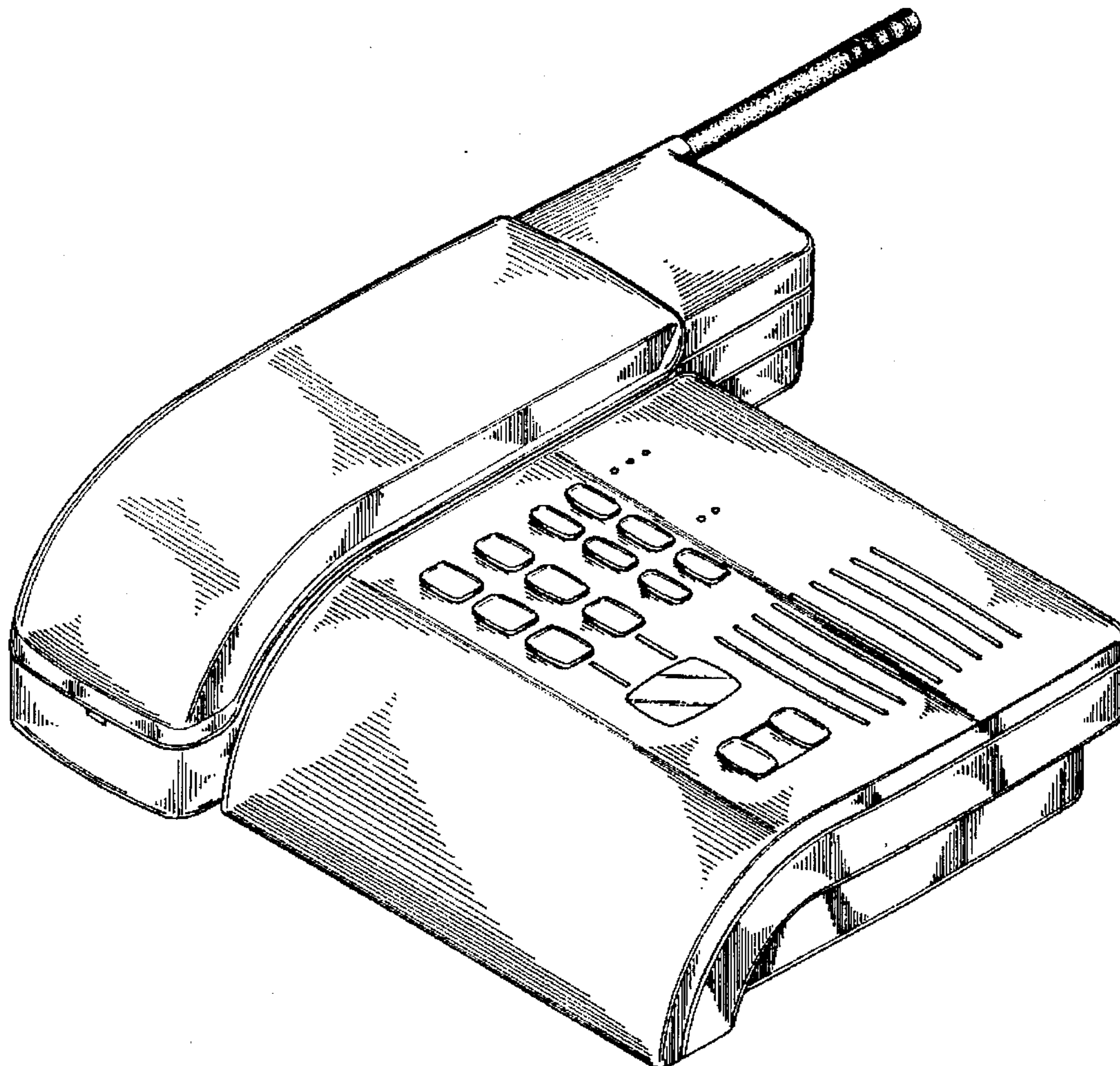

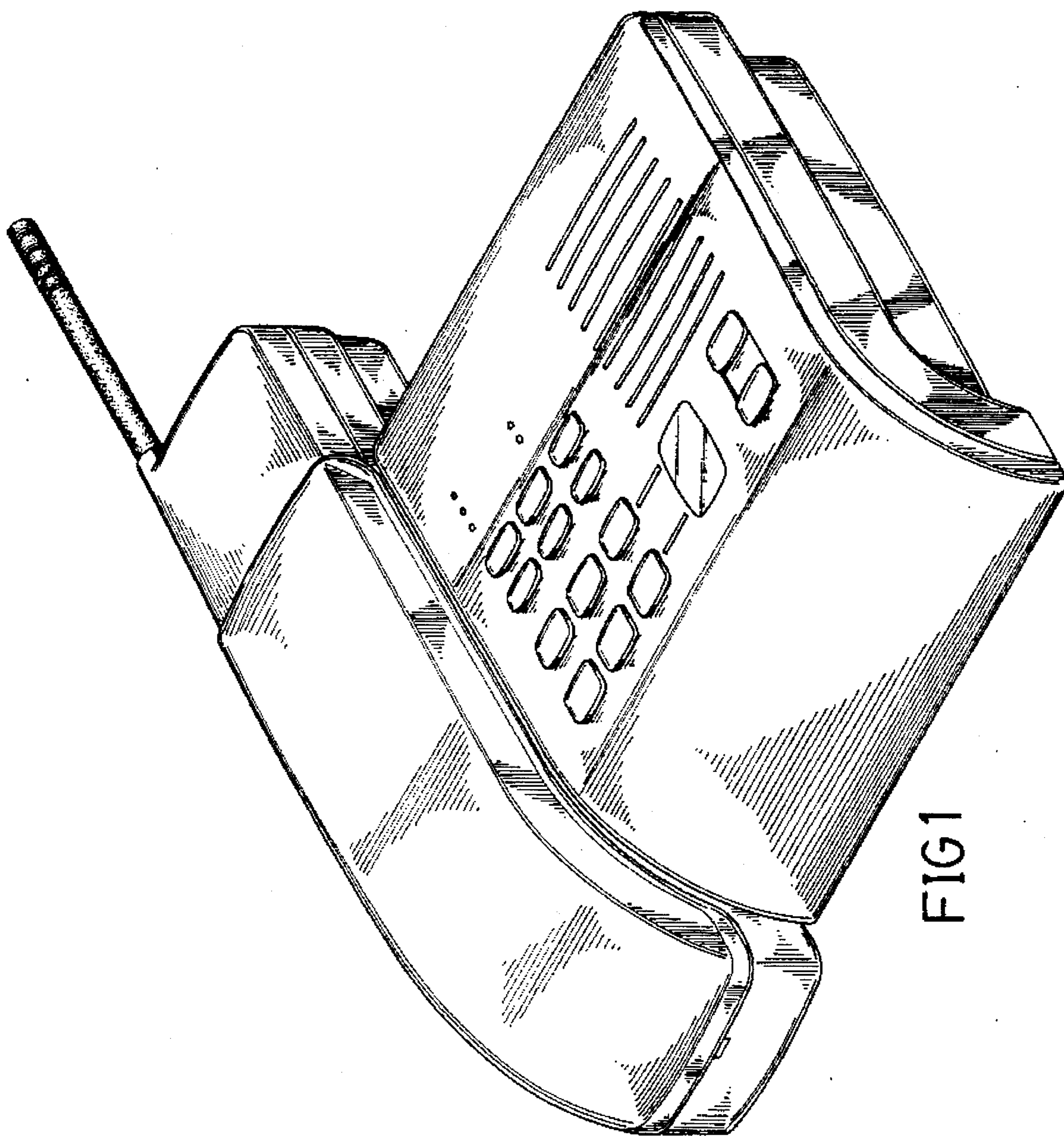

FIG1

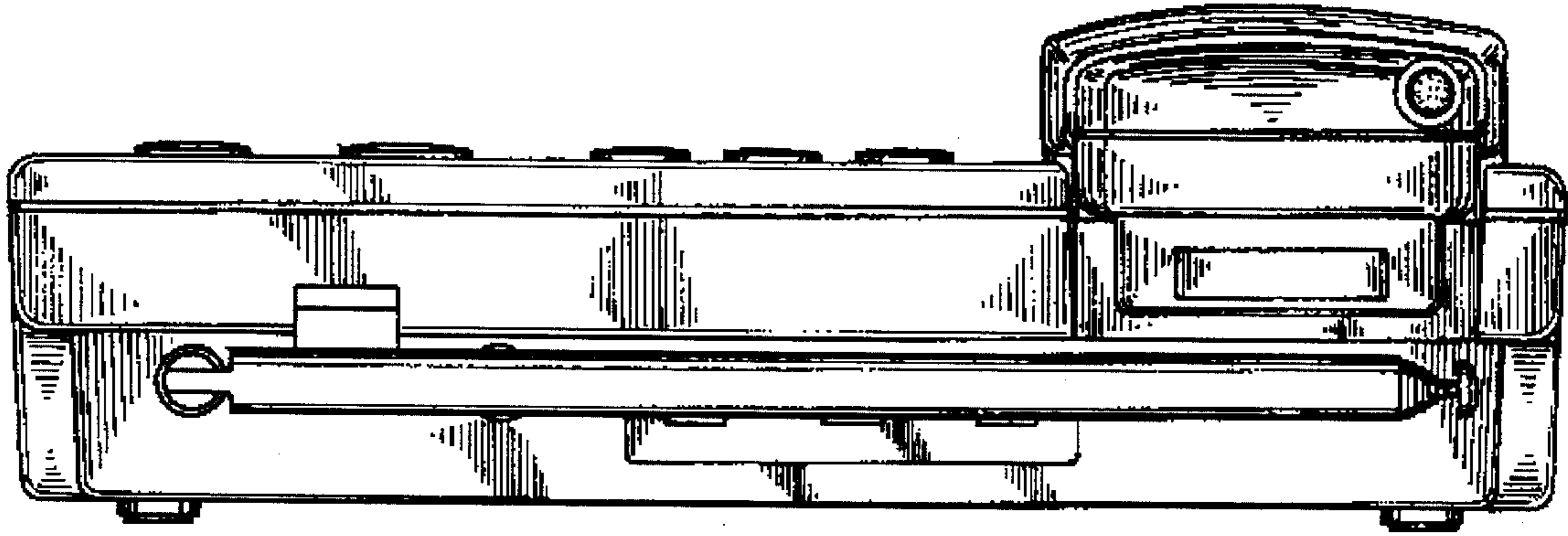

FIG 3

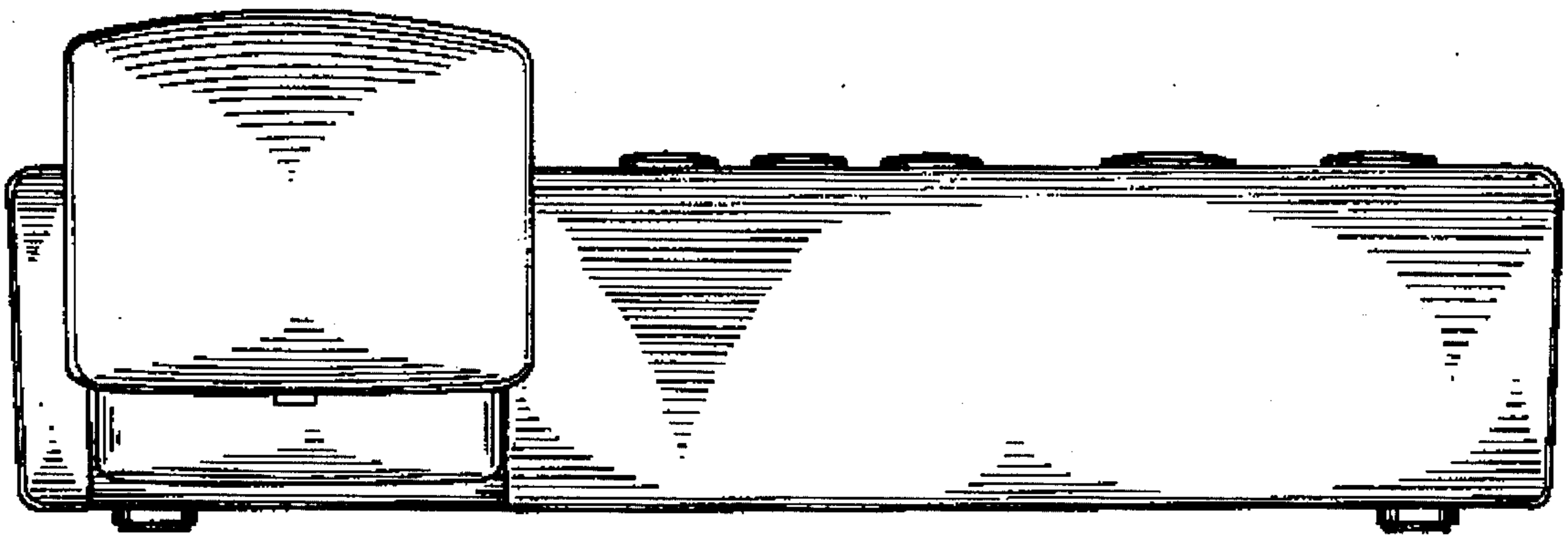

FIG 2

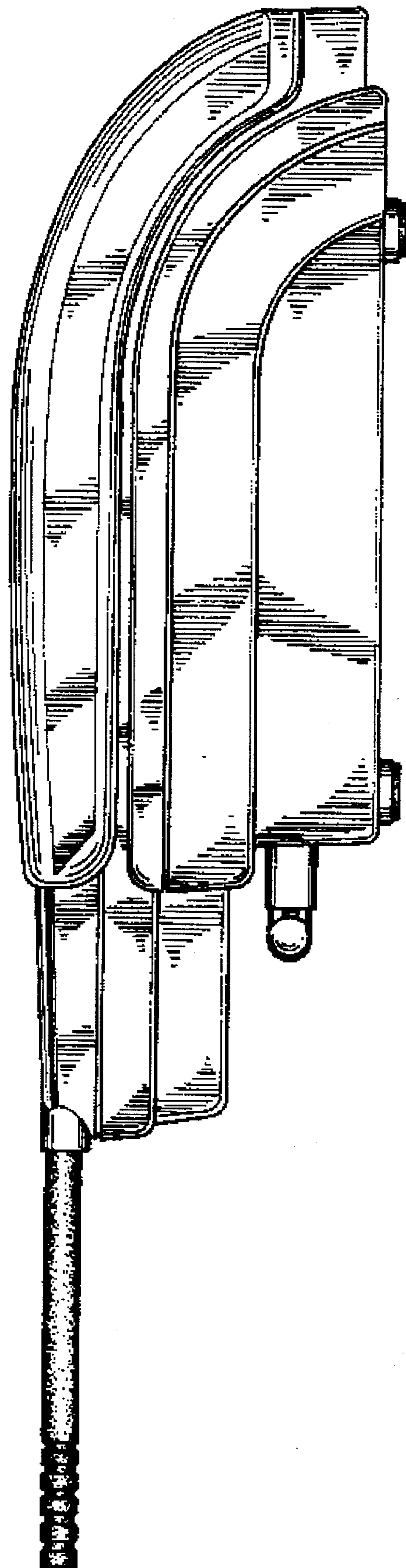

FIG 4

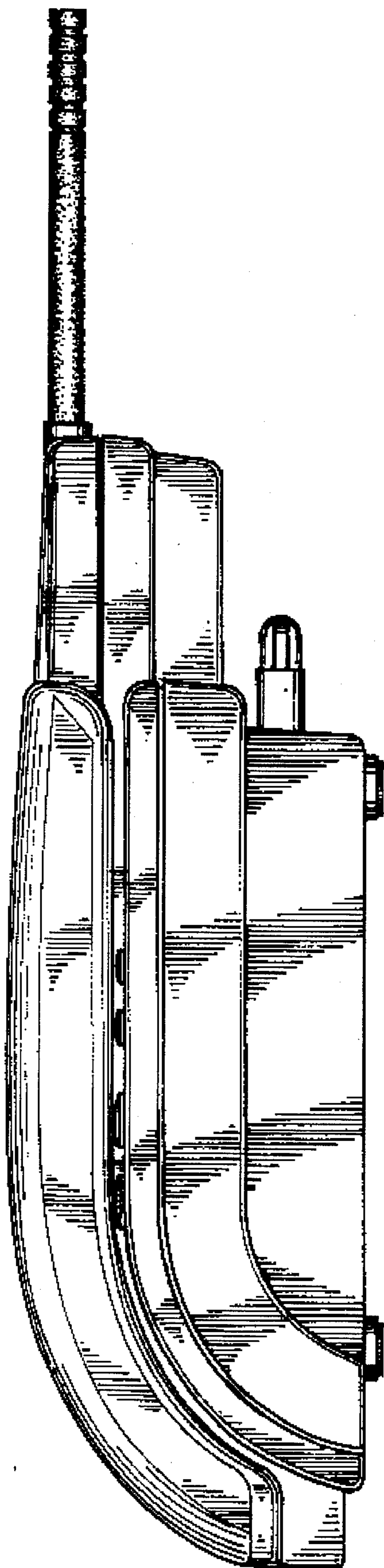

FIG 5

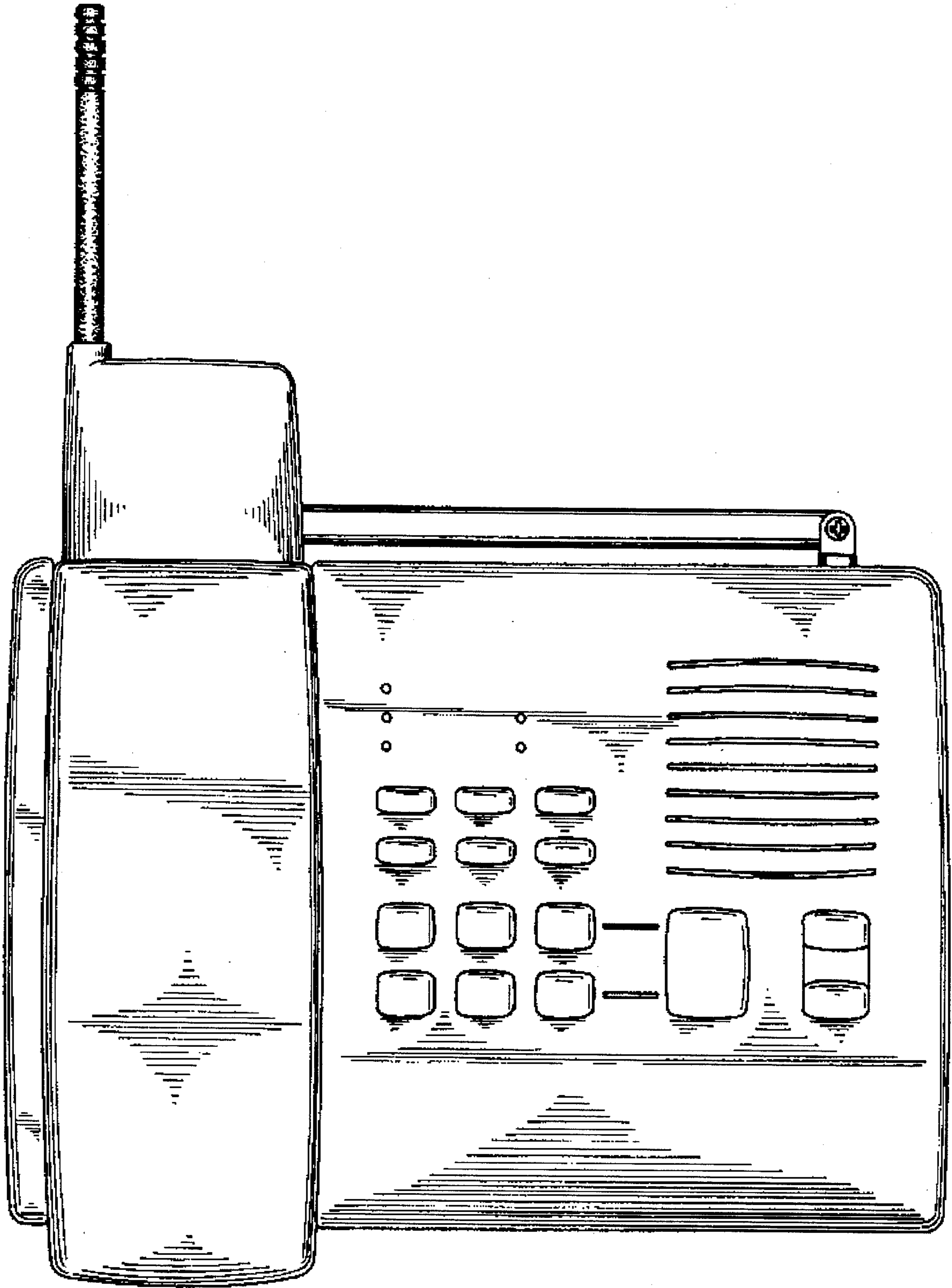

FIG 6

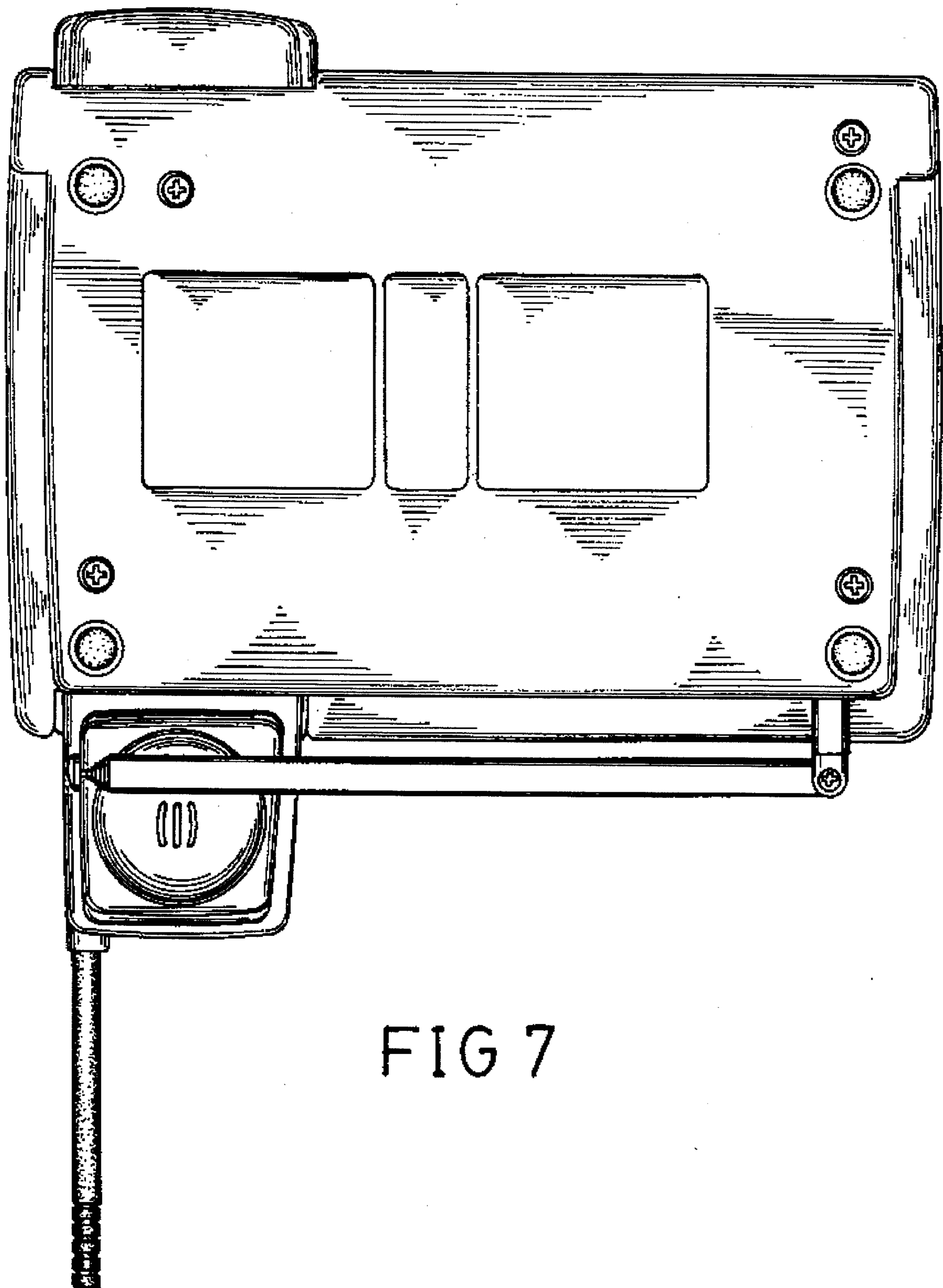

FIG 7