



US00D371940S

United States Patent [19] Krupa

[11] Patent Number: **Des. 371,940**
[45] Date of Patent: ****Jul. 23, 1996**

[54] **FOOD CONTAINER**

[75] Inventor: **Calvin S. Krupa, Medina, Minn.**

[73] Assignee: **Ultra Pac, Inc.**

[**] Term: **14 Years**

[21] Appl. No.: **41,784**

[22] Filed: **Jul. 24, 1995**

[52] U.S. Cl. **D7/549; D7/555**

[58] Field of Search **D7/505, 503, 507, D7/538, 540, 541, 542, 543, 545, 546, 549, 550, 552, 553, 554, 555, 557, 560, 565, 354, 357, 360, 566, 568, 570, 572, 584, 586, 587, 602, 611, 614, 615; D9/443, 428, 347; 220/608, 575, 23.8, 556, 669, 670, 671; 206/561, 564**

[56] **References Cited**

U.S. PATENT DOCUMENTS

D. 178,537	8/1956	Rauch	D7/543
D. 219,263	11/1970	Castelli	D9/347
D. 235,498	6/1975	Day	D7/554
D. 251,951	5/1979	Florian	D9/347

D. 269,854	7/1983	Commisso	D9/347
D. 284,727	7/1986	Gerber	D7/546
D. 305,713	1/1990	Seifried	D7/554
D. 344,658	3/1994	Arkoosh, Jr. et al.	D7/550 X
5,423,453	6/1995	Fritz	220/608
5,456,379	10/1995	Krupa et al.	220/608 X

Primary Examiner—M. N. Pandozzi
Attorney, Agent, or Firm—Haugen & Nikolai

[57] CLAIM

The ornamental design for a food container, as shown and described.

DESCRIPTION

FIG. 1 is a perspective view of the food container of the present invention;
FIG. 2 is a top plan view of the food container of the present invention;
FIG. 3 is a bottom plan view of the food container of the present invention;
FIG. 4 is a left side elevational view thereof;
FIG. 5 is a right side elevational view thereof;
FIG. 6 is a front elevational view thereof; and,
FIG. 7 is a rear elevational view thereof.

1 Claim, 3 Drawing Sheets

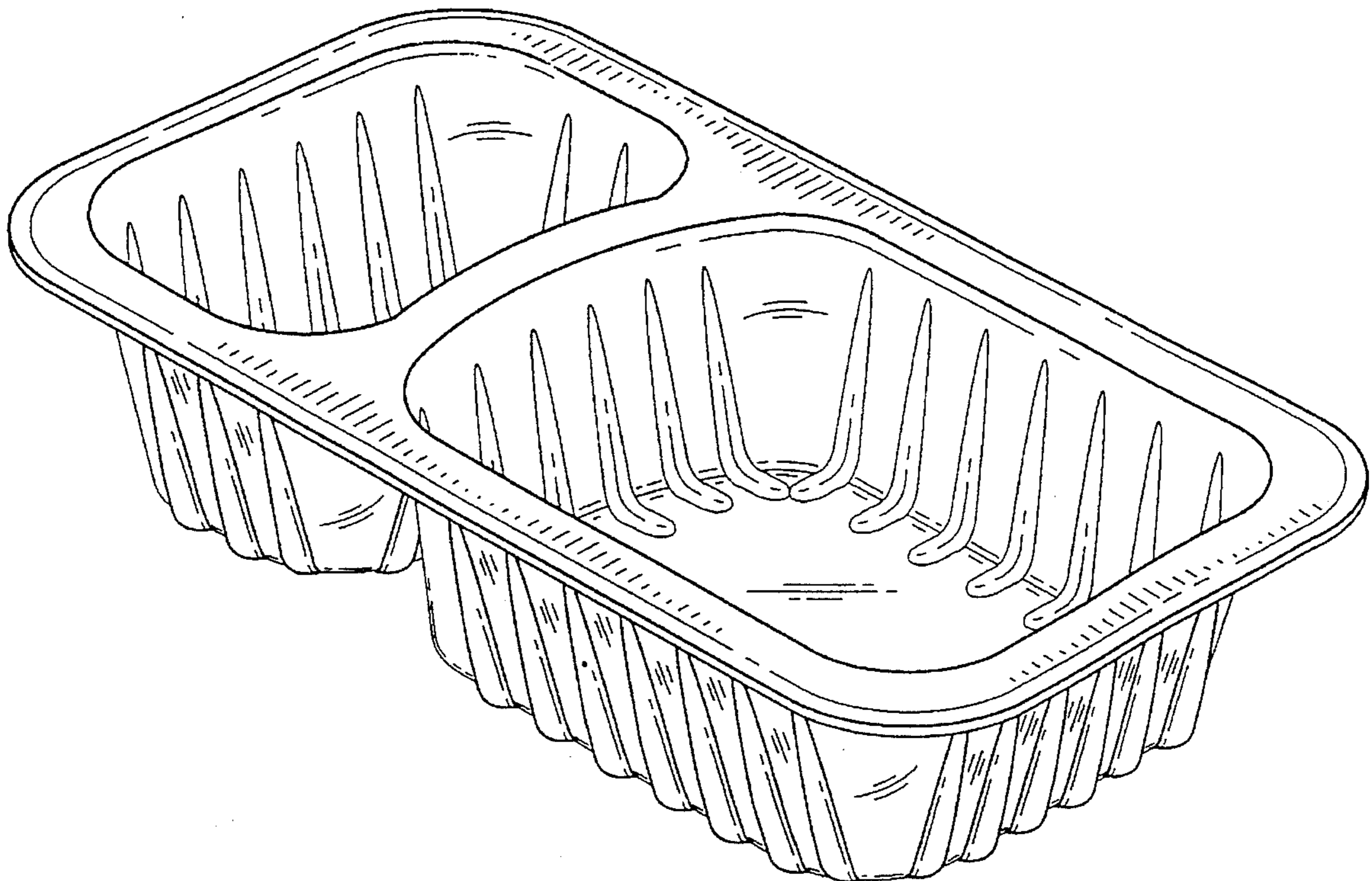

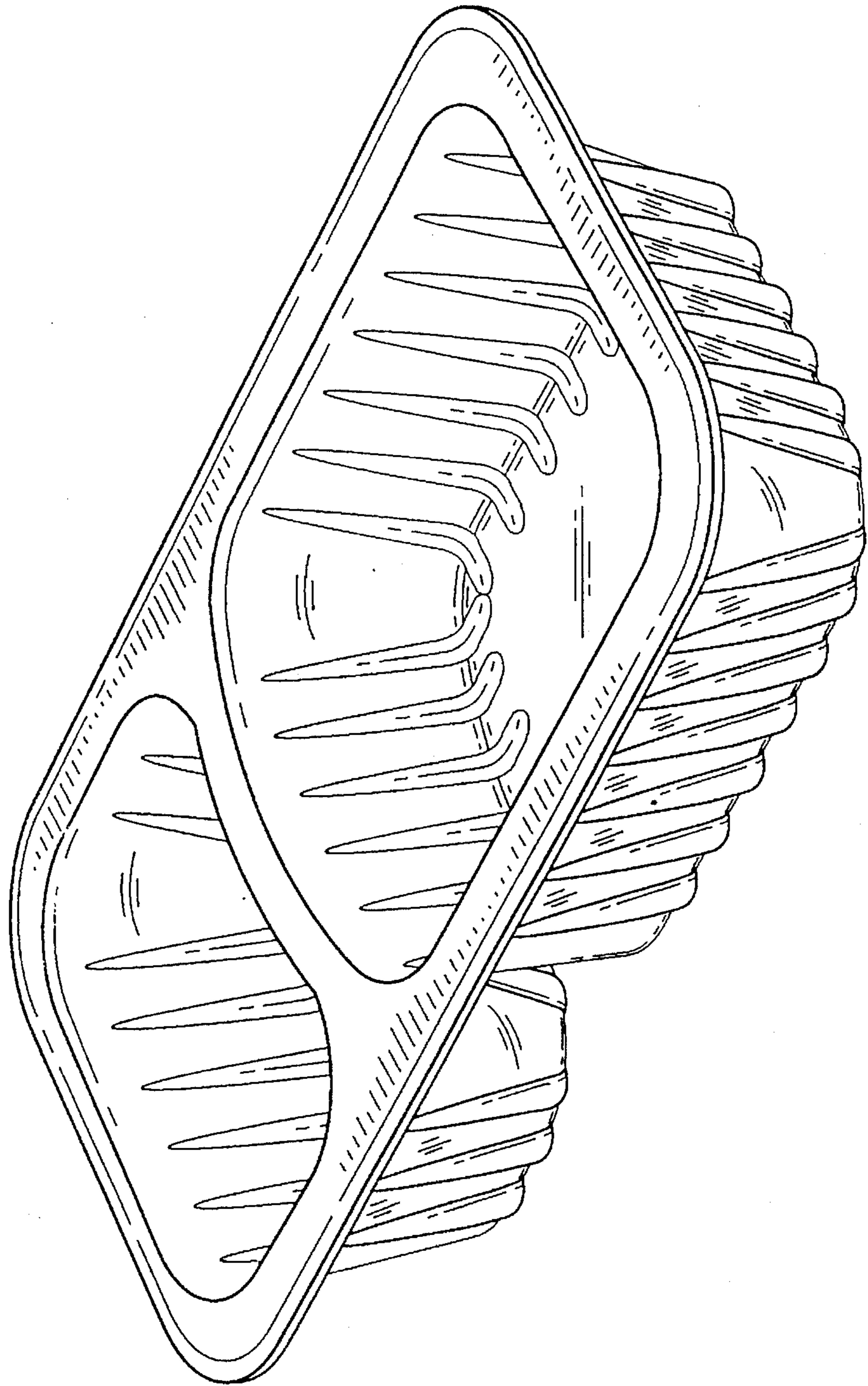

Fig. 1

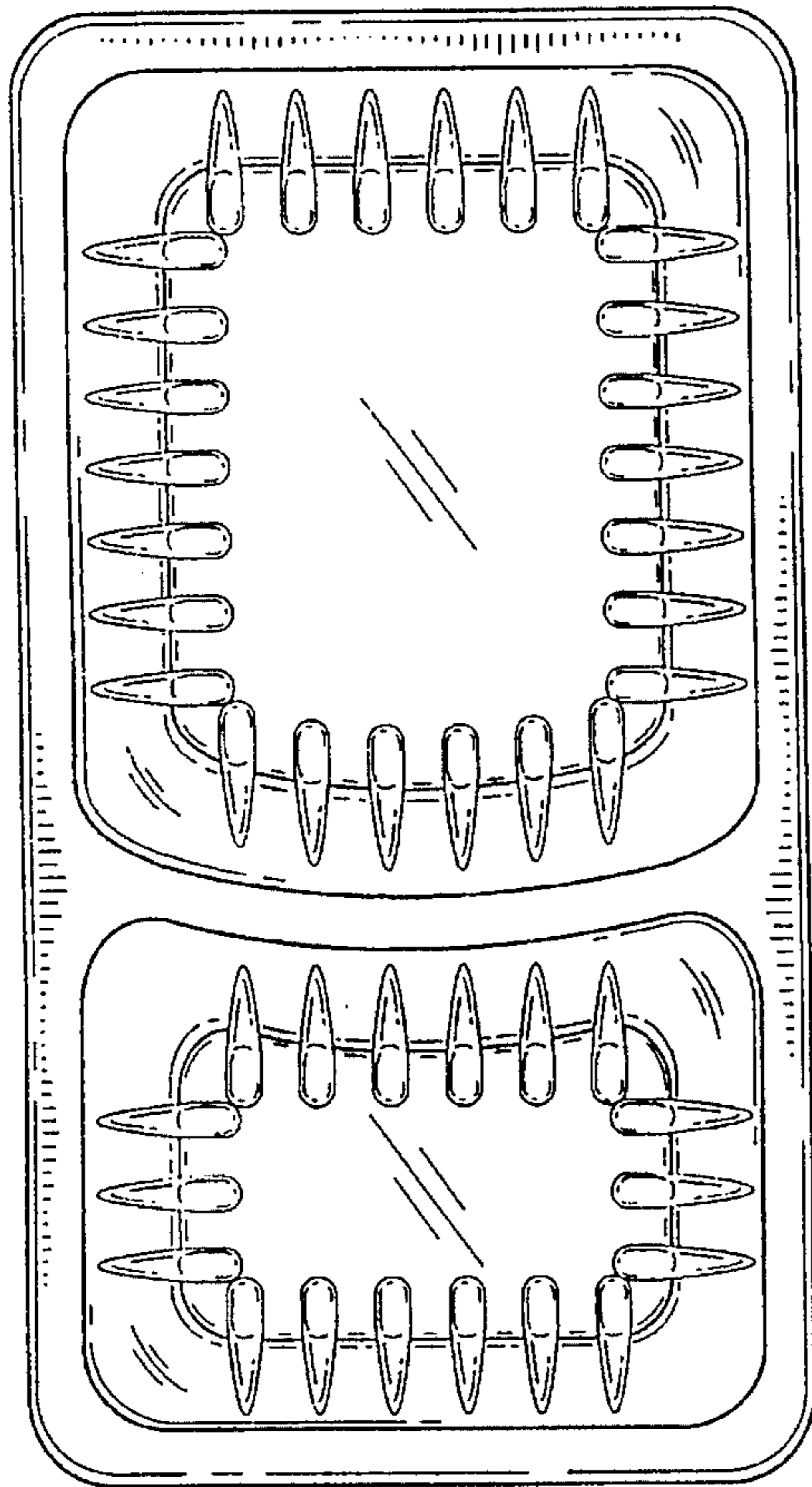

Fig. 2

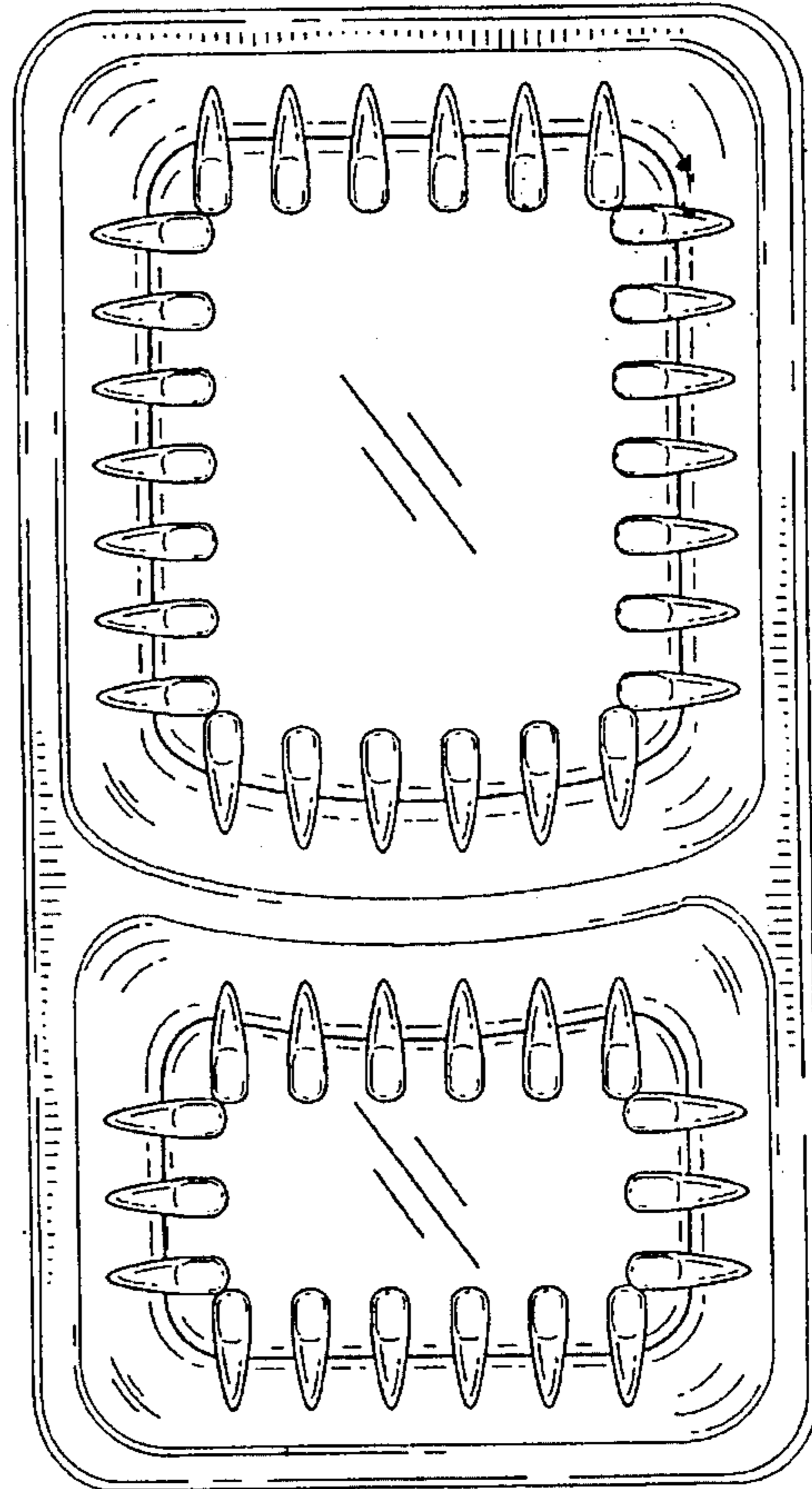

Fig. 3

Fig. 4

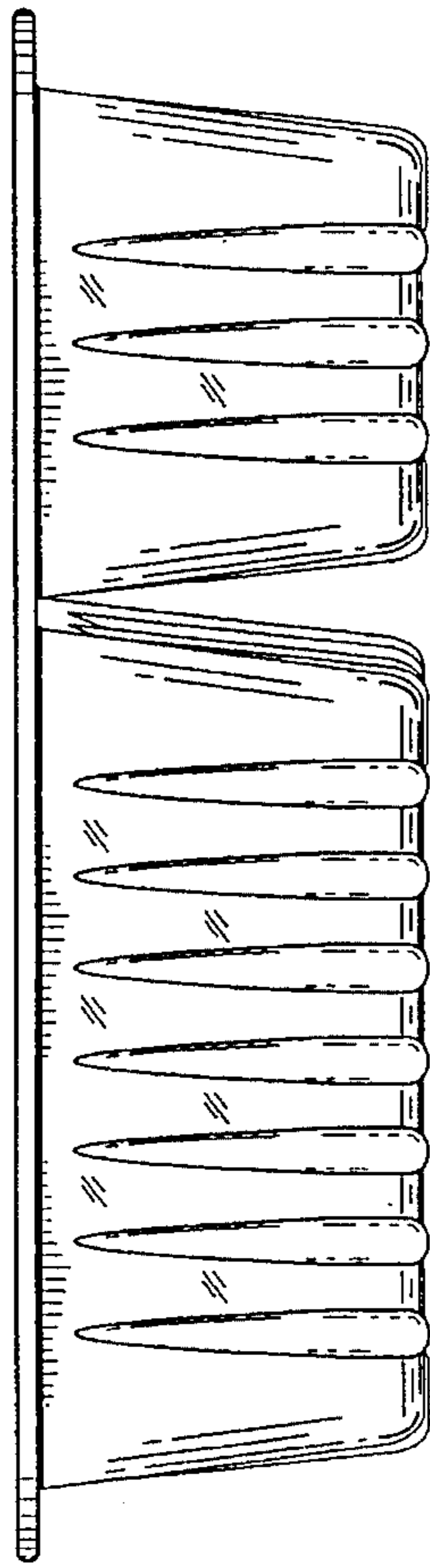

Fig. 6

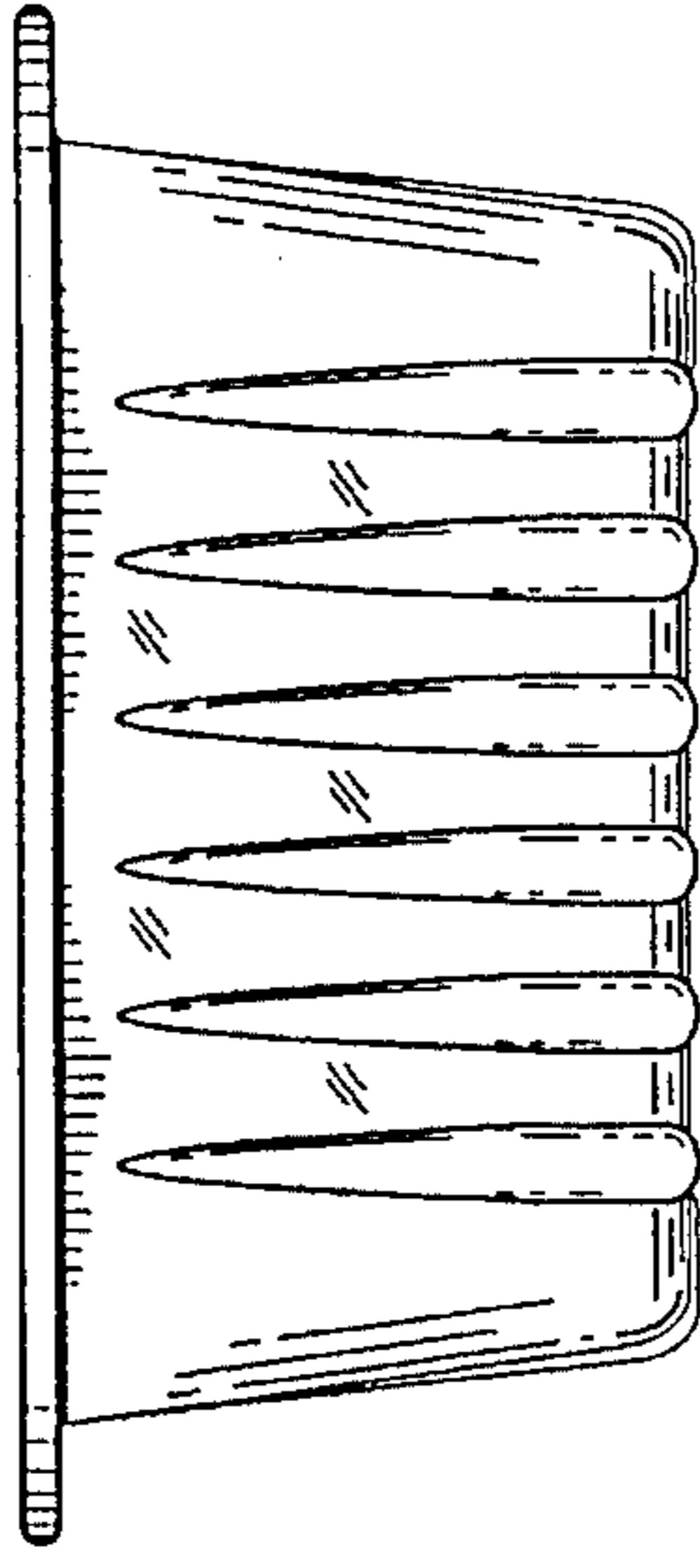

Fig. 5

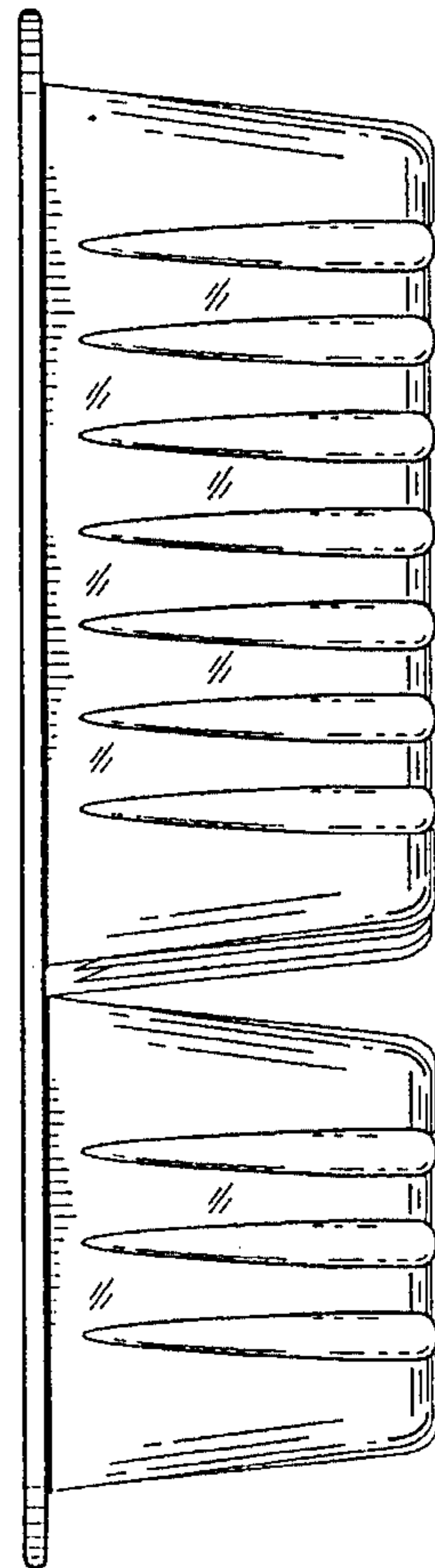

Fig. 7

