



US00D371766S

# United States Patent [19]

[11] Patent Number: **Des. 371,766**

Lucente, II et al.

[45] Date of Patent: **\*\*Jul. 16, 1996**

[54] **PORTABLE PERSONAL COMPUTER**

*Primary Examiner*—Freda Nunn

[75] Inventors: **Samuel A. Lucente, II**, Stamford, Conn.; **Thomas E. Pangburn**, Lexington, Ky.; **Marco M. Rengan**, Boca Raton, Fla.

*Attorney, Agent, or Firm*—Martin J. McKinley; Andrew J. Dillon

[73] Assignee: **International Business Machines Corporation**, Armonk, N.Y.

## [57] CLAIM

The ornamental design for a portable personal computer, as shown and described.

[\*\*] Term: **14 Years**

## DESCRIPTION

[21] Appl. No.: **25,438**

FIG. 1 is a perspective view of the portable personal computer of the present invention;

[22] Filed: **Jul. 1, 1994**

FIG. 2 is a perspective view of the portable personal computer in an open position of the present invention;

[52] U.S. Cl. .... **D14/106**

FIG. 3 is a top view of the portable personal computer of the present invention;

[58] **Field of Search** ..... D14/100, 101, D14/106, 113, 115, 124-127; D18/1, 7, 11, 12, 2; 235/145 A, 145 R; 345/104, 156, 168, 173, 901-905, 87; 341/22, 23; 361/679-686; 364/708.1, 709.04, 709.12; 400/486, 489

FIG. 4 is a front view of the portable personal computer of the present invention;

FIG. 5 is a right side view of the portable personal computer of the present invention;

FIG. 6 is a rear view of the portable personal computer of the present invention;

FIG. 7 is a left side view of the portable personal computer of the present invention; and,

FIG. 8 is a bottom view of the portable personal computer of the present invention.

## [56] References Cited

### U.S. PATENT DOCUMENTS

D. 336,465	6/1993	Kim	.....	D14/106
D. 345,149	3/1994	Toedter et al.	.....	D14/106
D. 347,627	6/1994	Gotoh	.....	D14/106

**1 Claim, 4 Drawing Sheets**

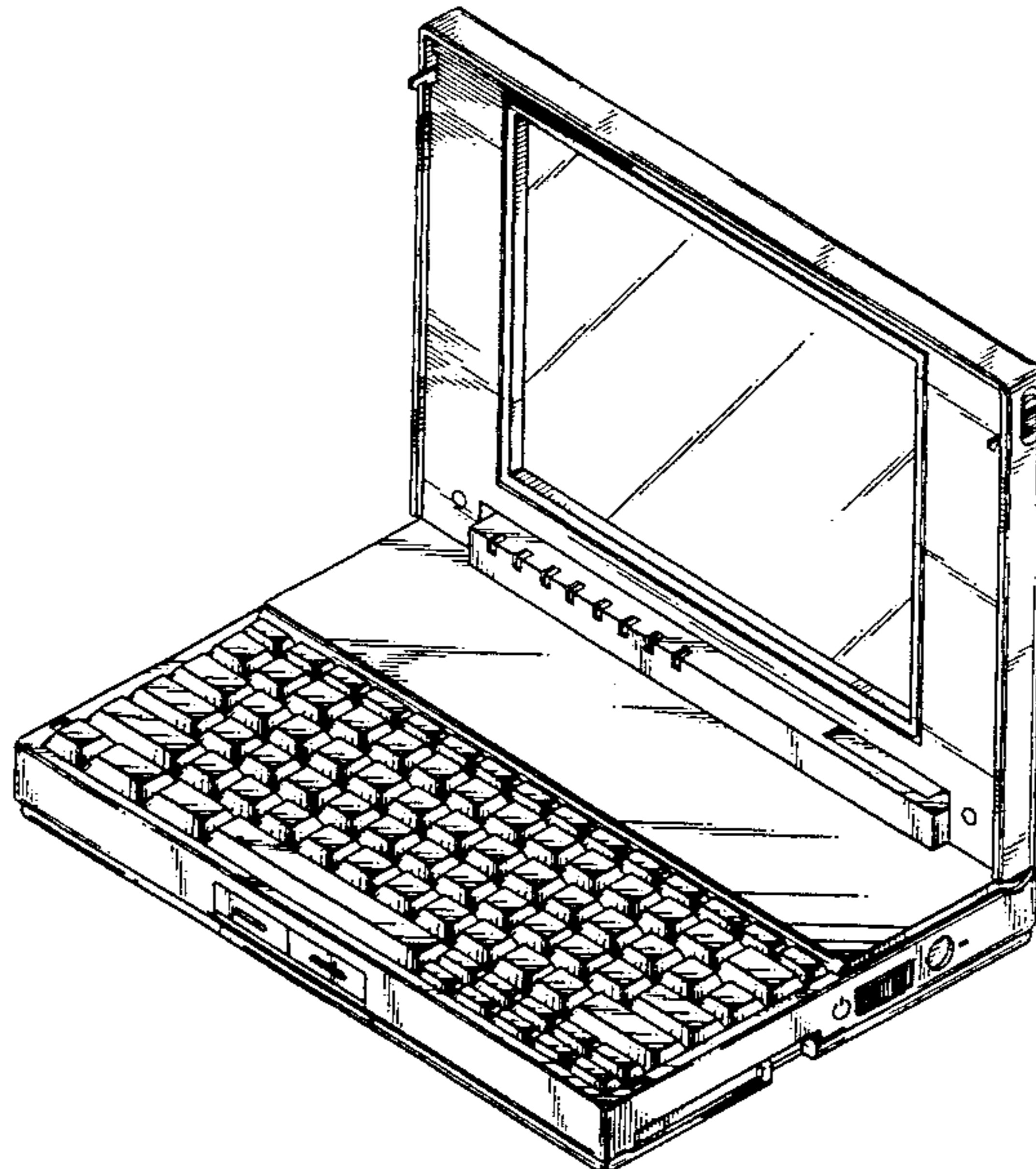
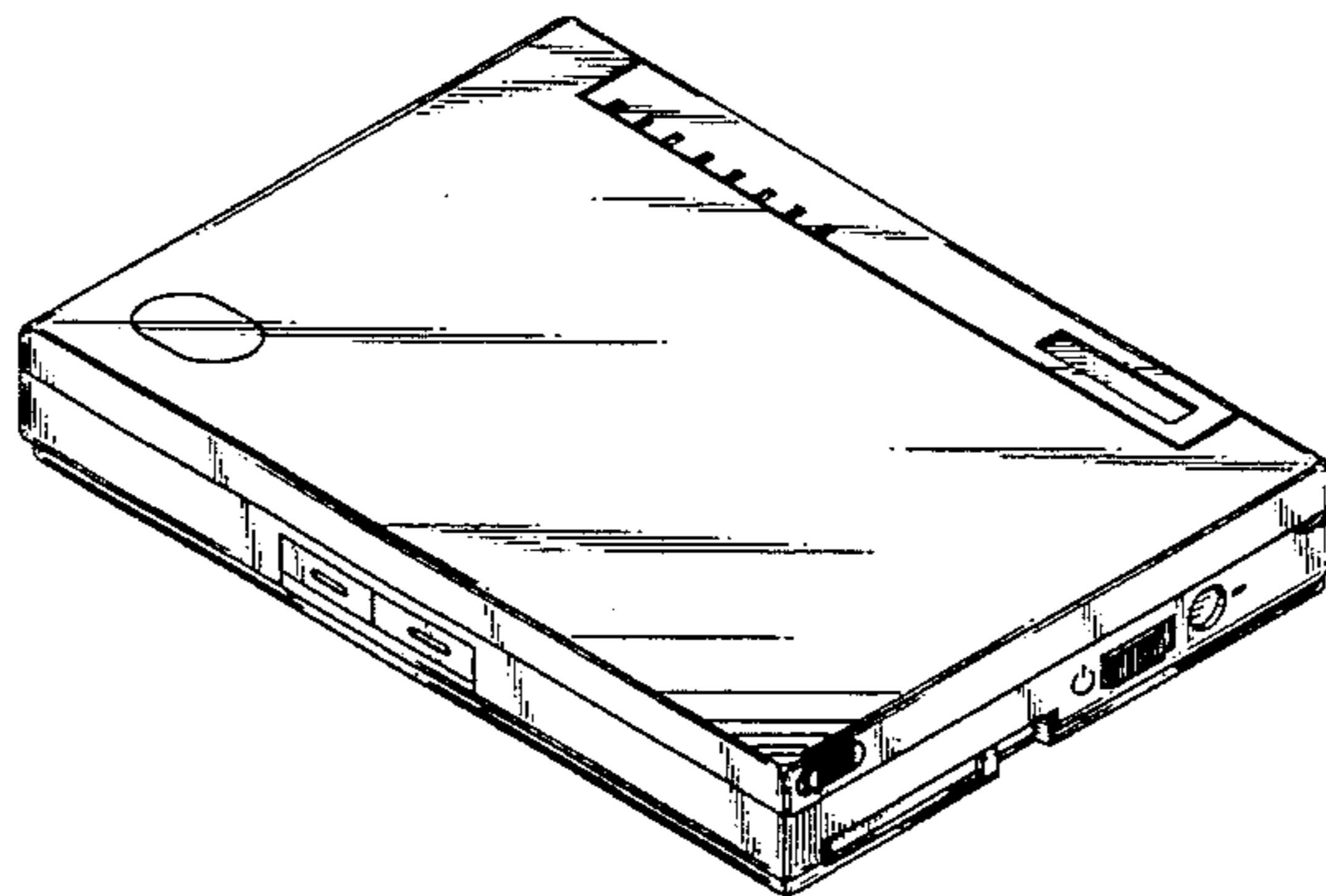

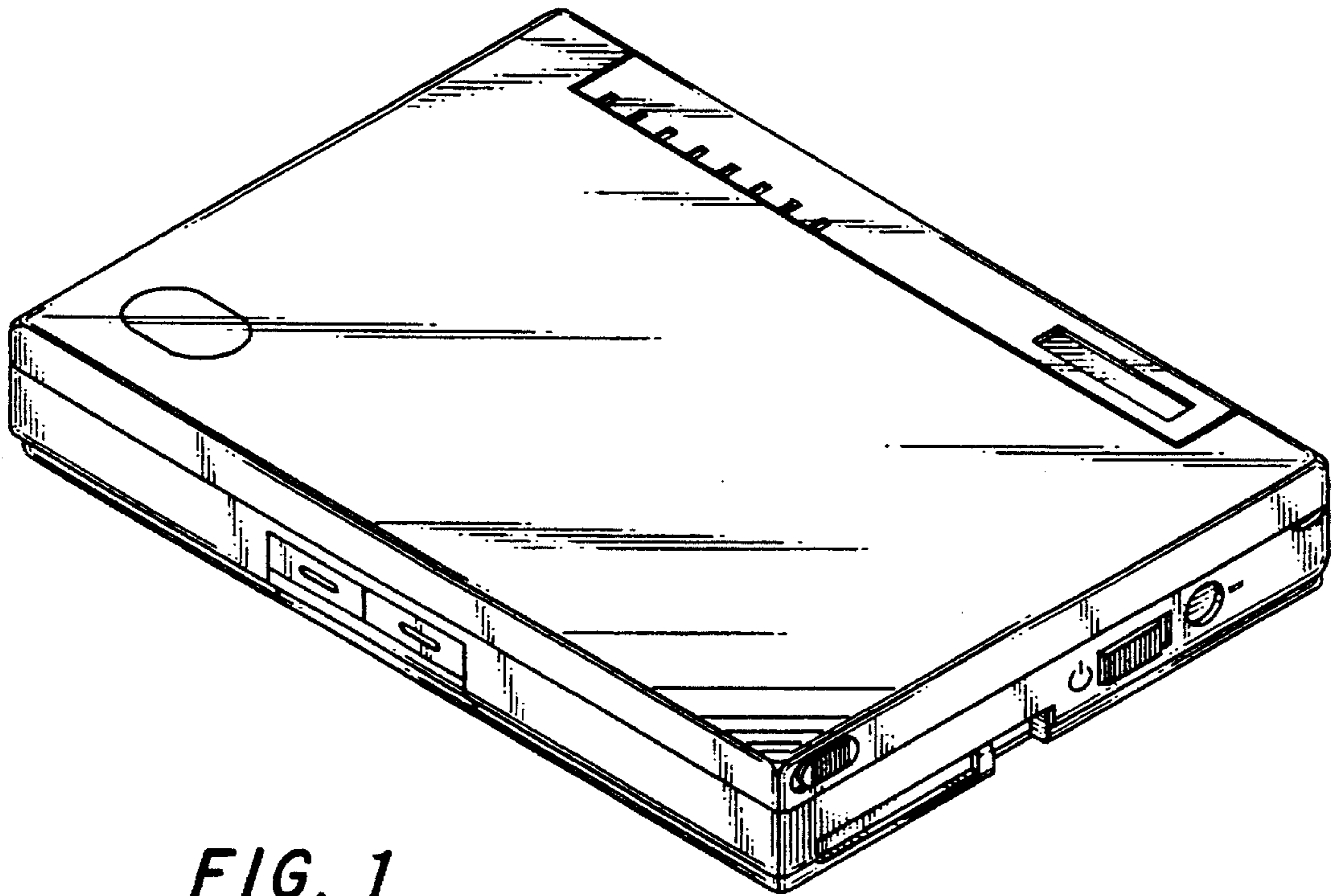

*FIG. 1*

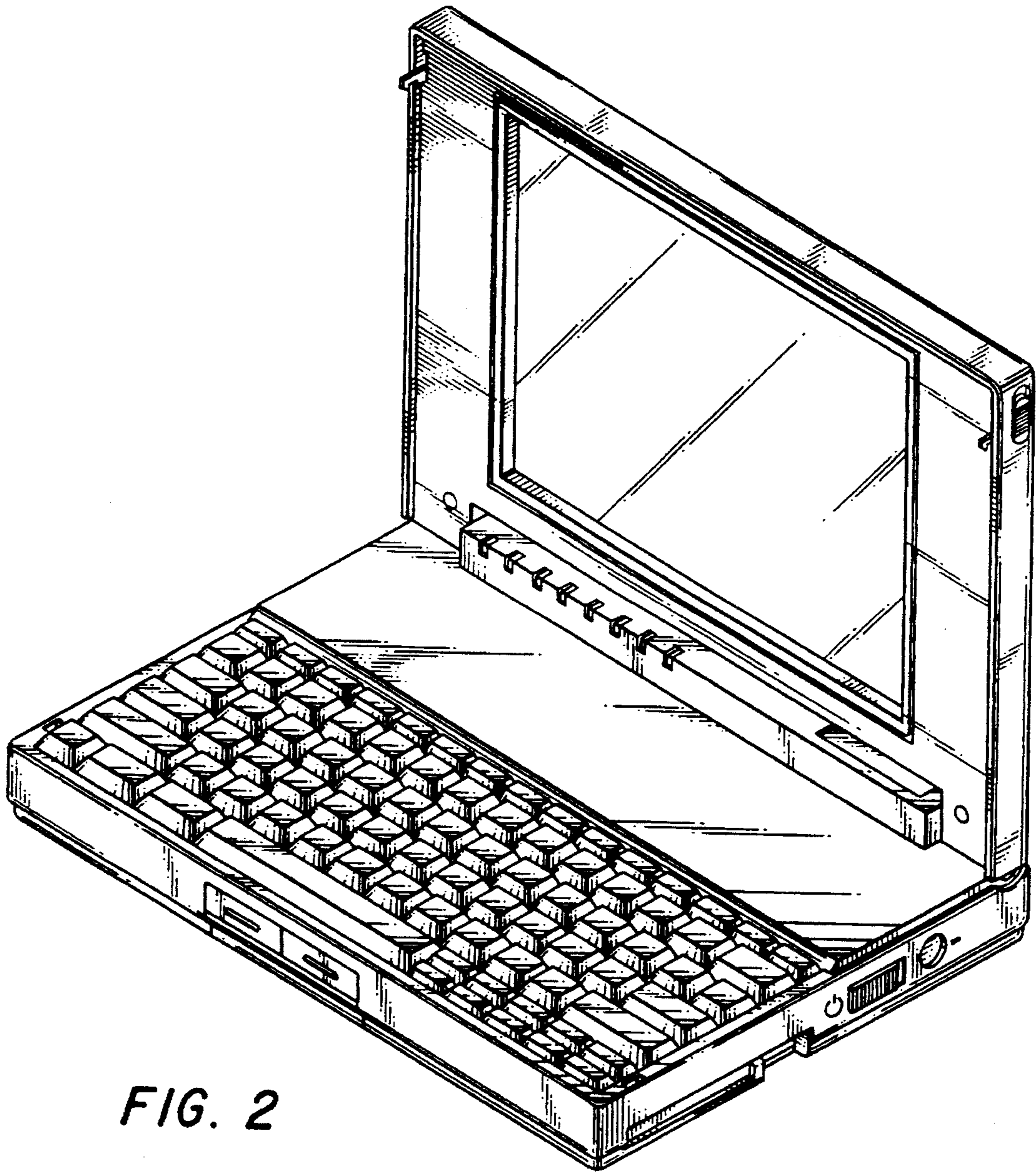

*FIG. 2*



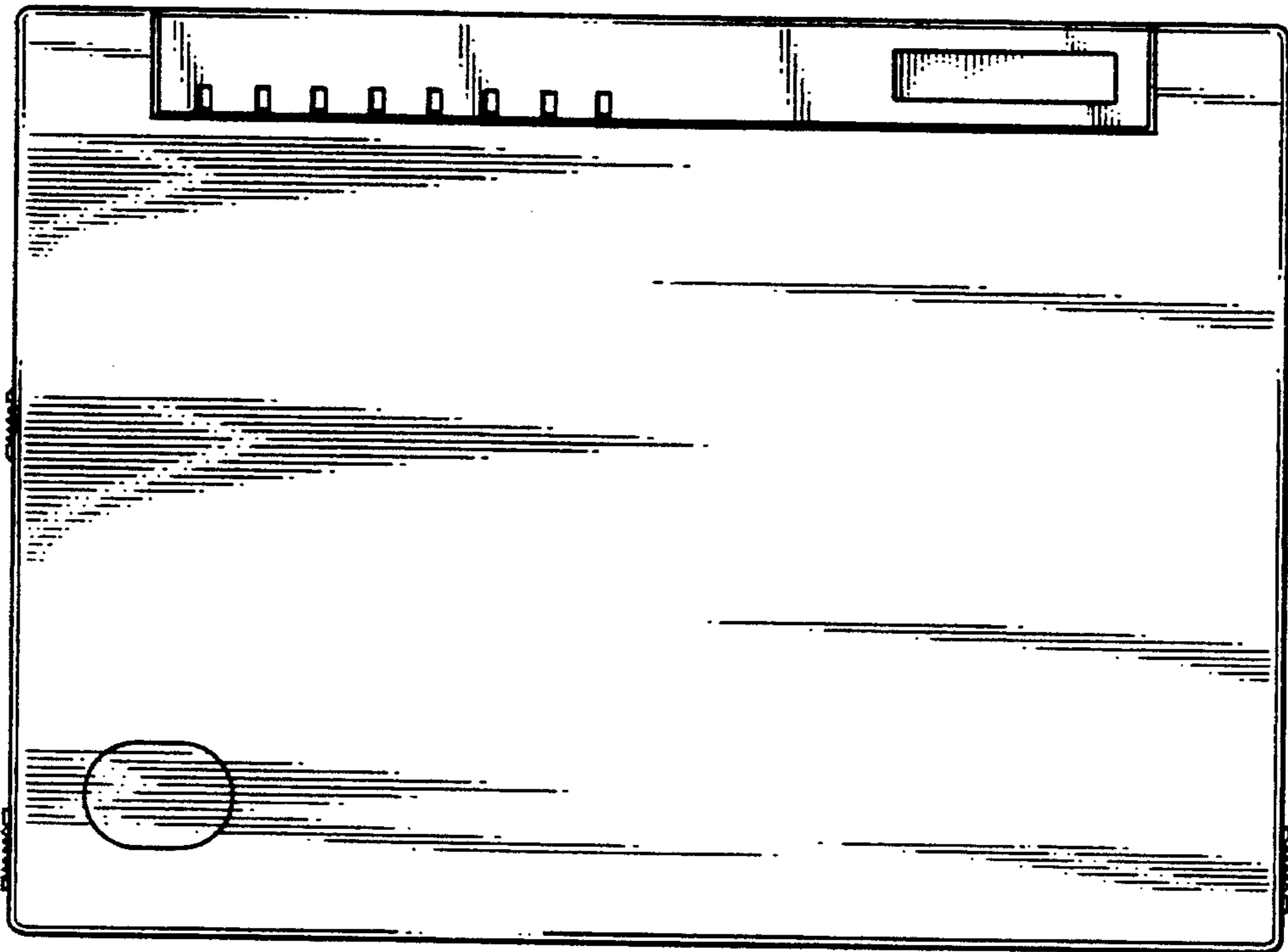

FIG. 3

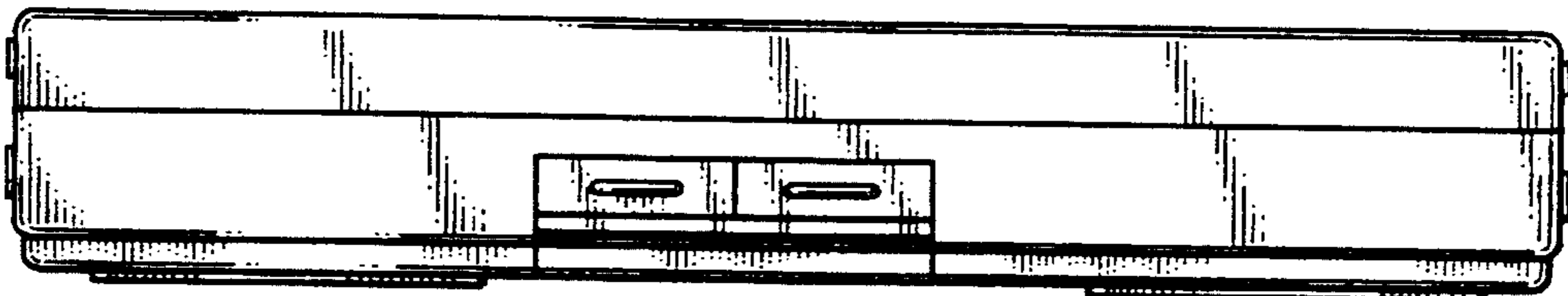

FIG. 4

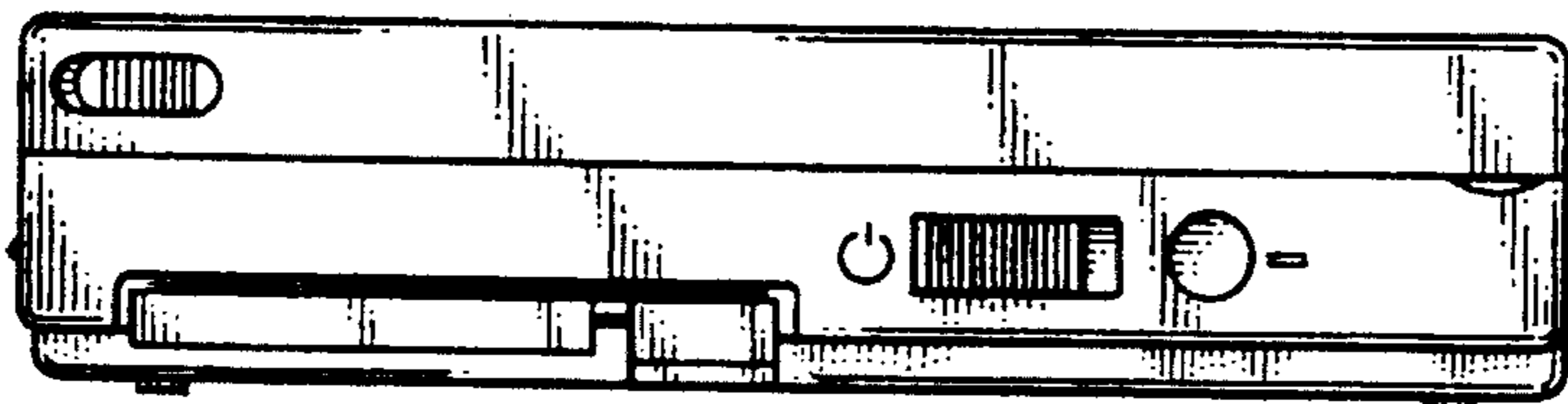

FIG. 5

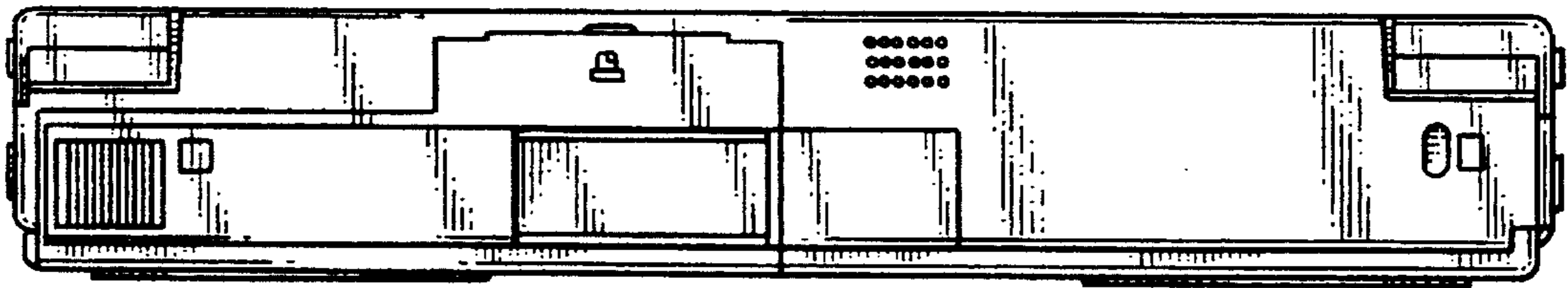

FIG. 6

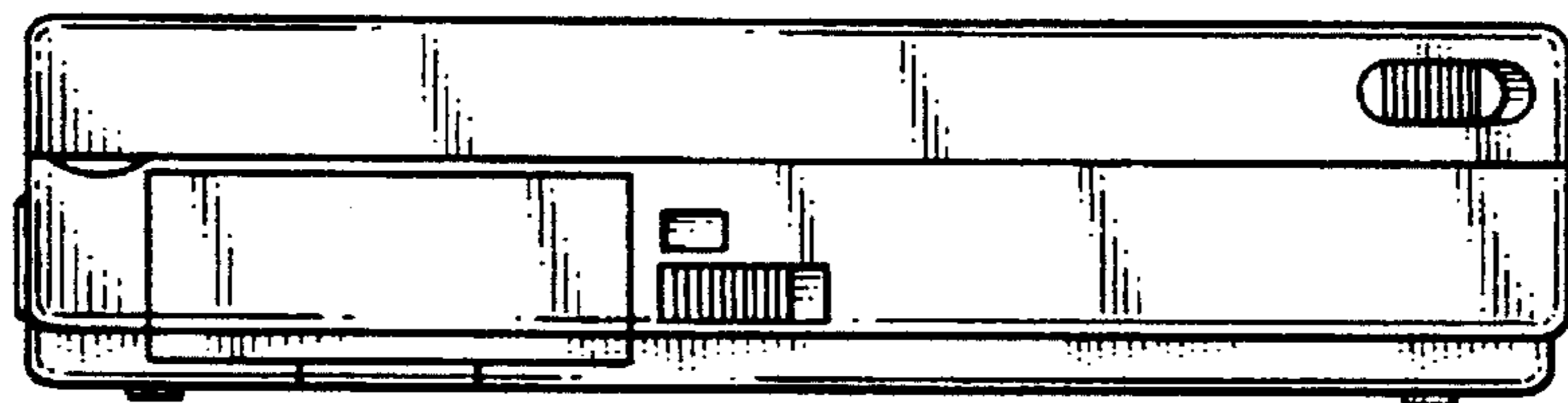

FIG. 7

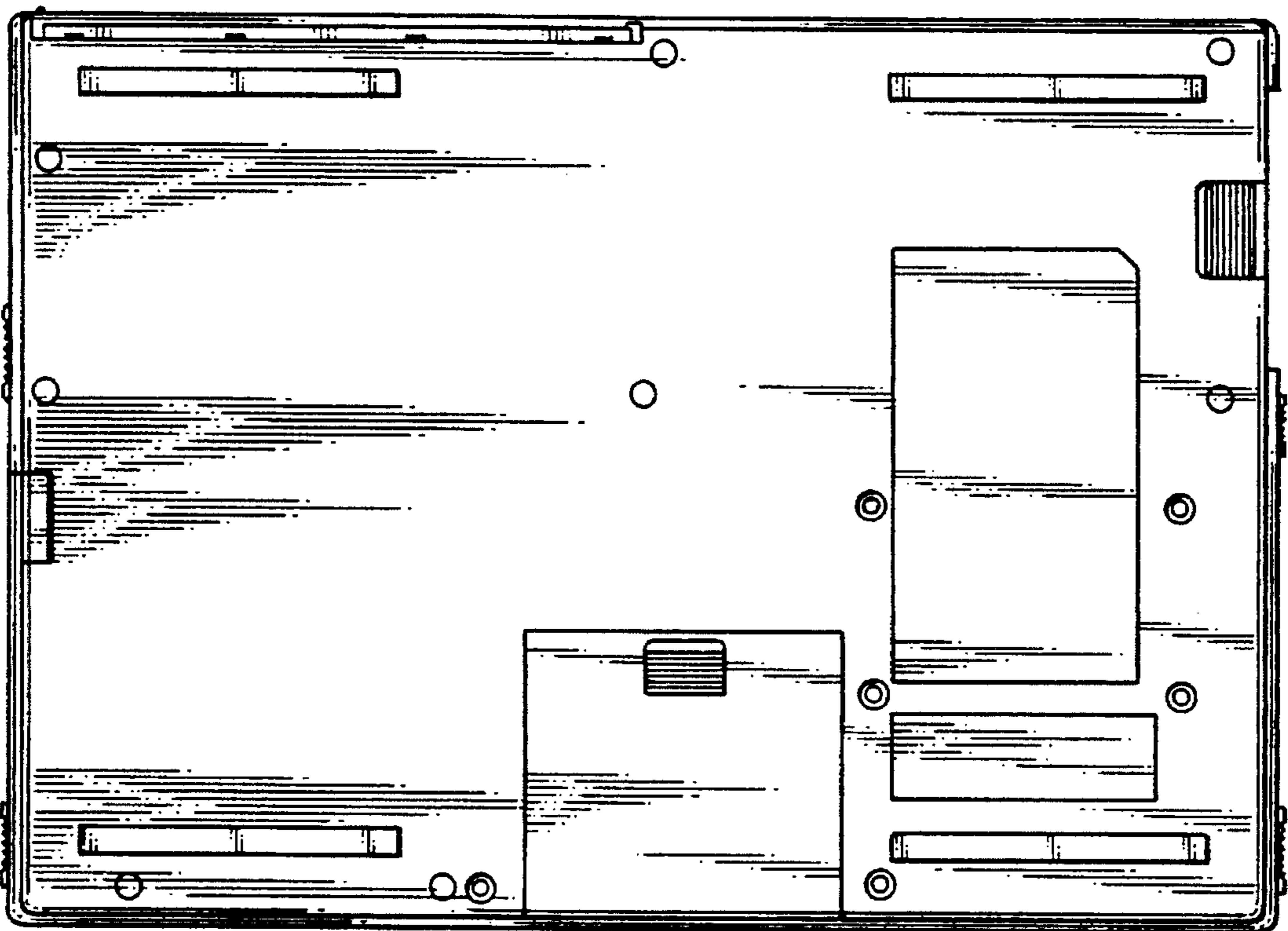

FIG. 8