



US00D371765S

United States Patent [19]

Moss et al.

[11] Patent Number: Des. 371,765

[45] Date of Patent: **Jul. 16, 1996

[54] **CARD READER**

[75] Inventors: **John L. Moss**, Wayland; **Brian Matteson**, Acton; **Luis Pedraza**, Hyde Park; **David Chastain**, Acton, all of Mass.; **Thomas Turner**, Nashua, N.H.

[73] Assignee: **Software House Inc.**, Waltham, Mass.

[**] Term: **14 Years**

[21] Appl. No.: **28,728**

[22] Filed: **Sep. 21, 1994**

[52] U.S. Cl. **D14/105**

[58] **Field of Search** D14/100, 105, D14/107; 235/380, 382, 382.5, 379, 493, 462, 472; 382/2, 7, 58, 59; 364/709.05, 709.06; 348/373-376; 358/408, 472, 474, 497

[56] **References Cited**

U.S. PATENT DOCUMENTS

D. 298,536	11/1988	Brefka	D14/105
D. 348,440	7/1994	Nair et al.	D14/105
D. 348,872	7/1994	Cherry	D14/105
D. 350,120	8/1994	Tsuboi et al.	D14/105

Primary Examiner—Freda Nunn

Attorney, Agent, or Firm—Pandiscio & Pandiscio

[57] **CLAIM**

The ornamental design for the card reader, as shown and described.

DESCRIPTION

FIG. 1 is a front view of a card reader showing one embodiment of our new design;

FIG. 2 is a bottom view of the card reader shown in FIG. 1;
 FIG. 3 is a top view of the card reader shown in FIG. 1;
 FIG. 4 is a left side view of the card reader shown in FIG. 1;
 FIG. 5 is a right side view of the card reader shown in FIG. 1;
 FIG. 6 is a rear view of the card reader shown in FIG. 1;
 FIG. 7 is a front view of a card reader showing another embodiment of our new design;
 FIG. 8 is a bottom view of the card reader shown in FIG. 7;
 FIG. 9 is a top view of the card reader shown in FIG. 7;
 FIG. 10 is a left side view of the card reader shown in FIG. 7;
 FIG. 11 is a right side view of the card reader shown in FIG. 7;
 FIG. 12 is a rear view of the card reader shown in FIG. 7;
 FIG. 13 is a front view of a card reader showing still another embodiment of our new design;
 FIG. 14 is a bottom view of the card reader shown in FIG. 13;
 FIG. 15 is a top view of the card reader shown in FIG. 13;
 FIG. 16 is a left side view of the card reader shown in FIG. 13;
 FIG. 17 is a right side view of the card reader shown in FIG. 13;
 FIG. 18 is a rear view of the card reader shown in FIG. 13;
 FIG. 19 is a perspective view of the card reader shown in FIGS. 1-6;
 FIG. 20 is a perspective view of the card reader shown in FIGS. 7-12; and,
 FIG. 21 is a perspective view of the card reader shown in FIGS. 13-18.

1 Claim, 9 Drawing Sheets

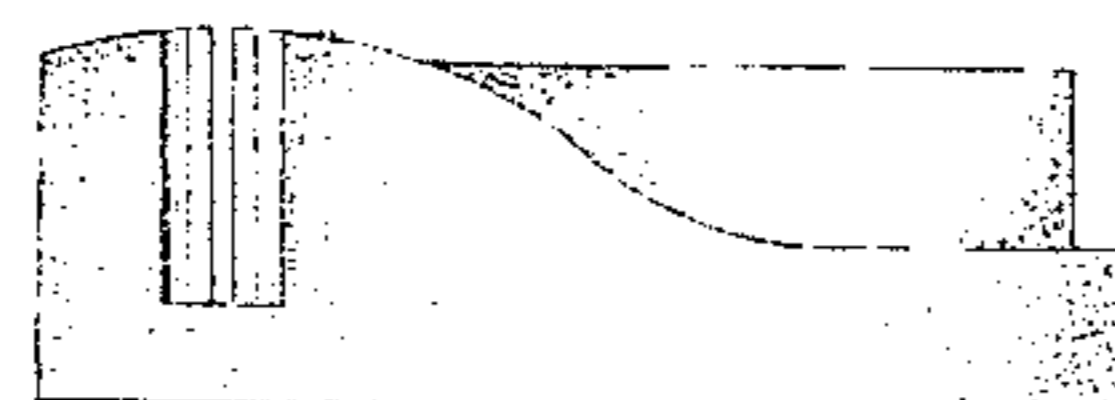
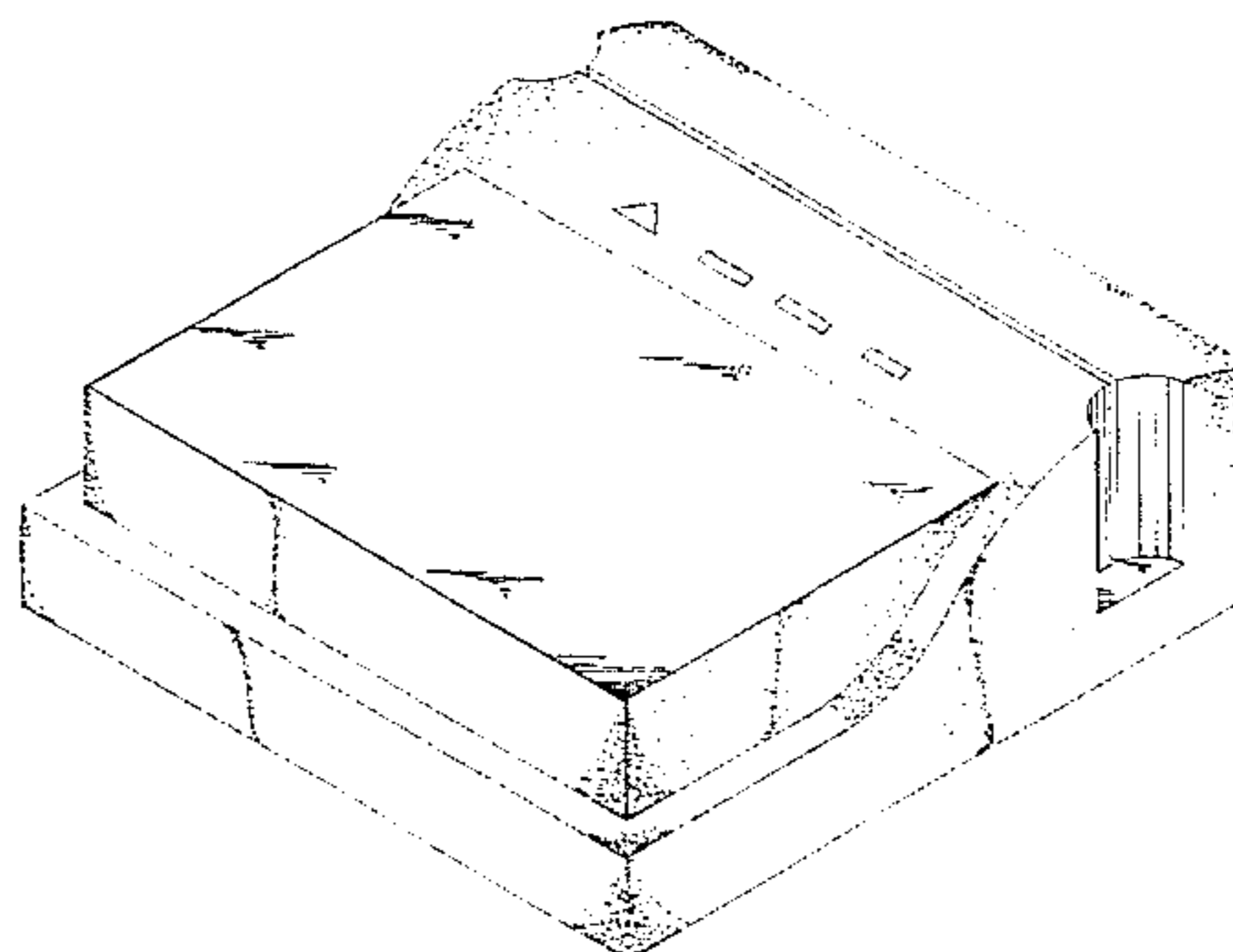
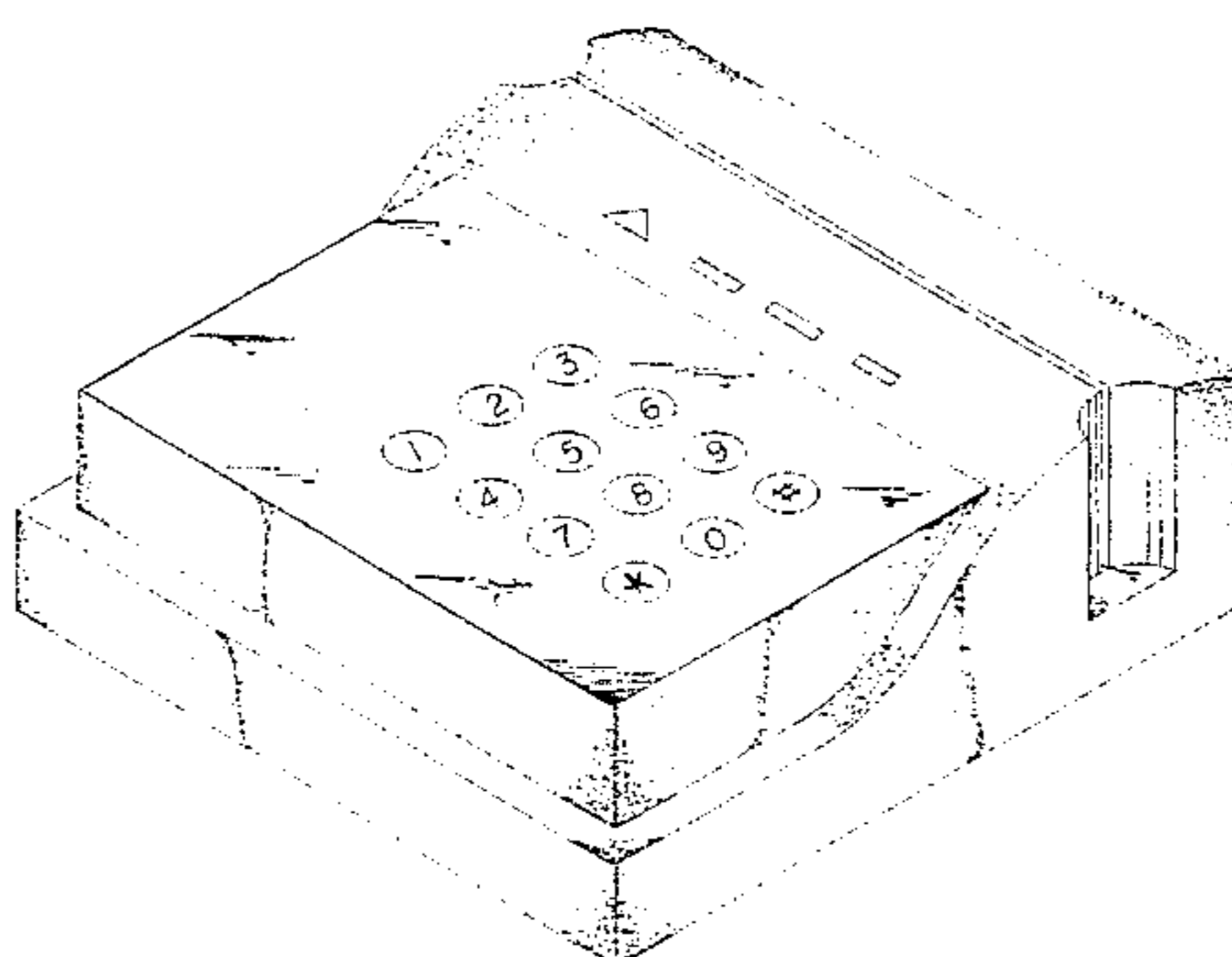
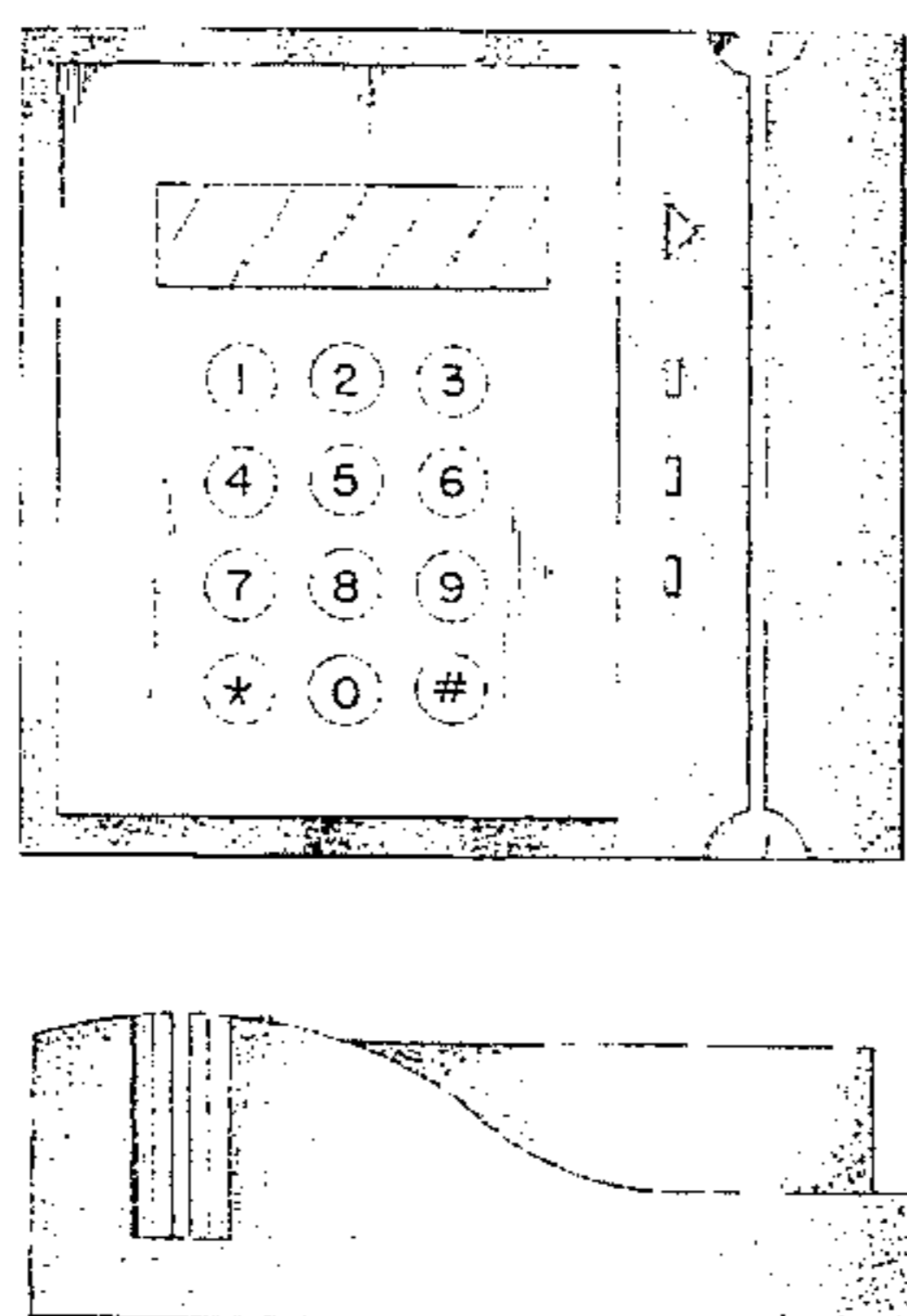

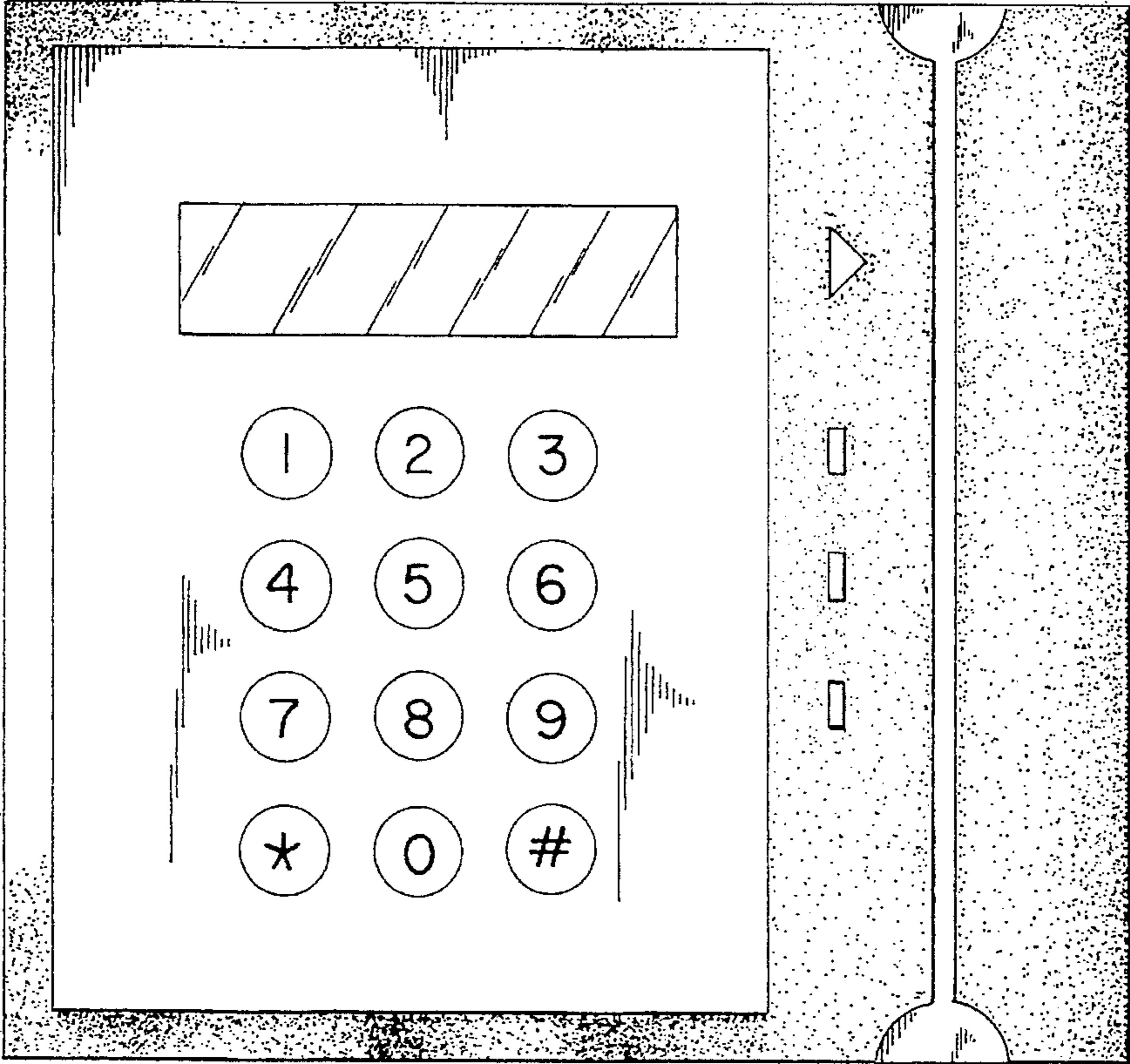

FIG. 1

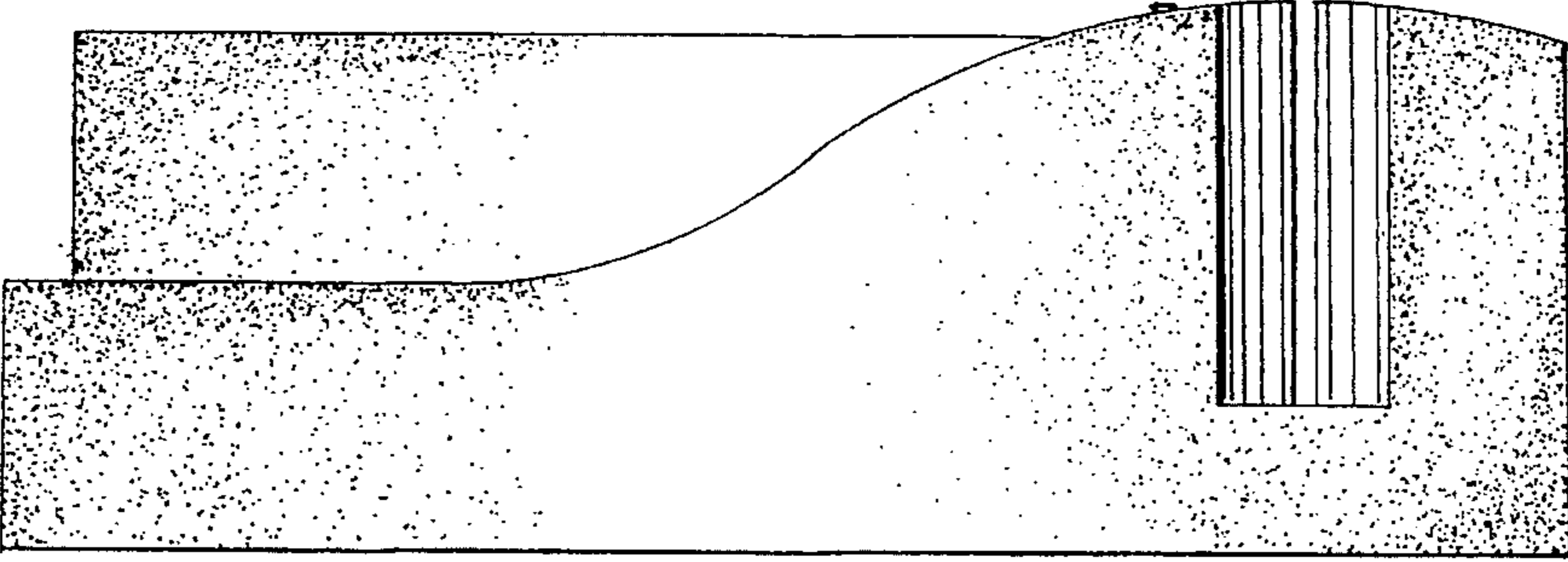

FIG. 2

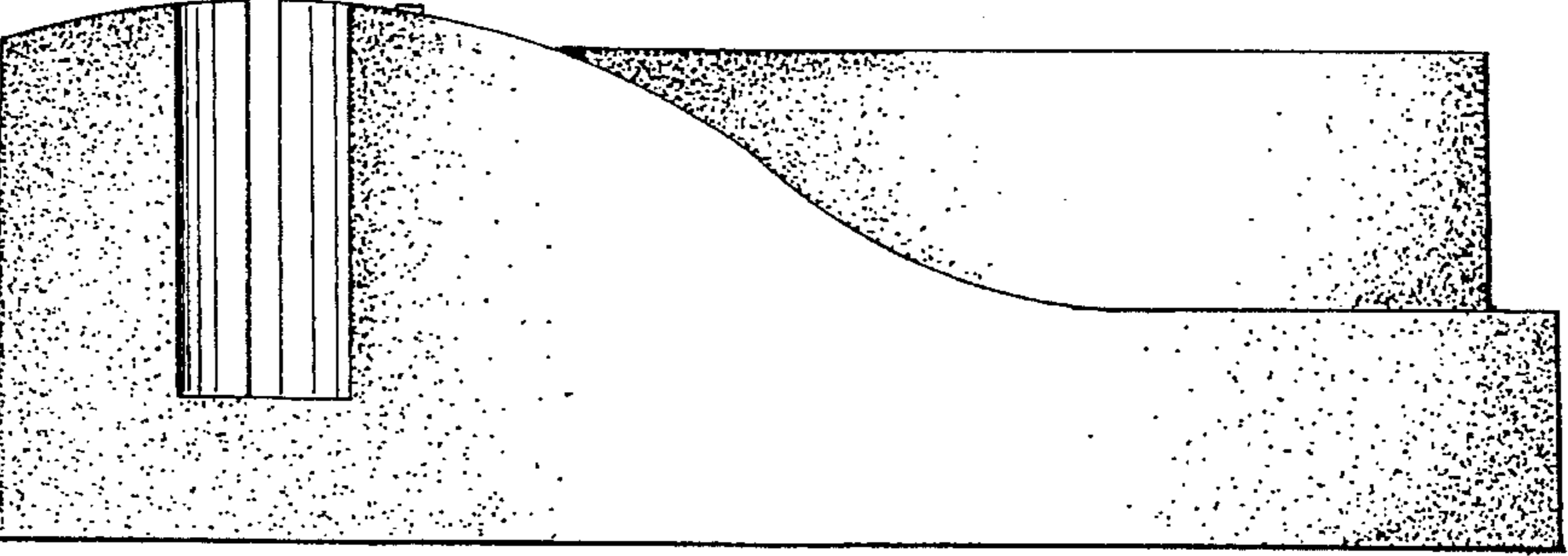

FIG. 3

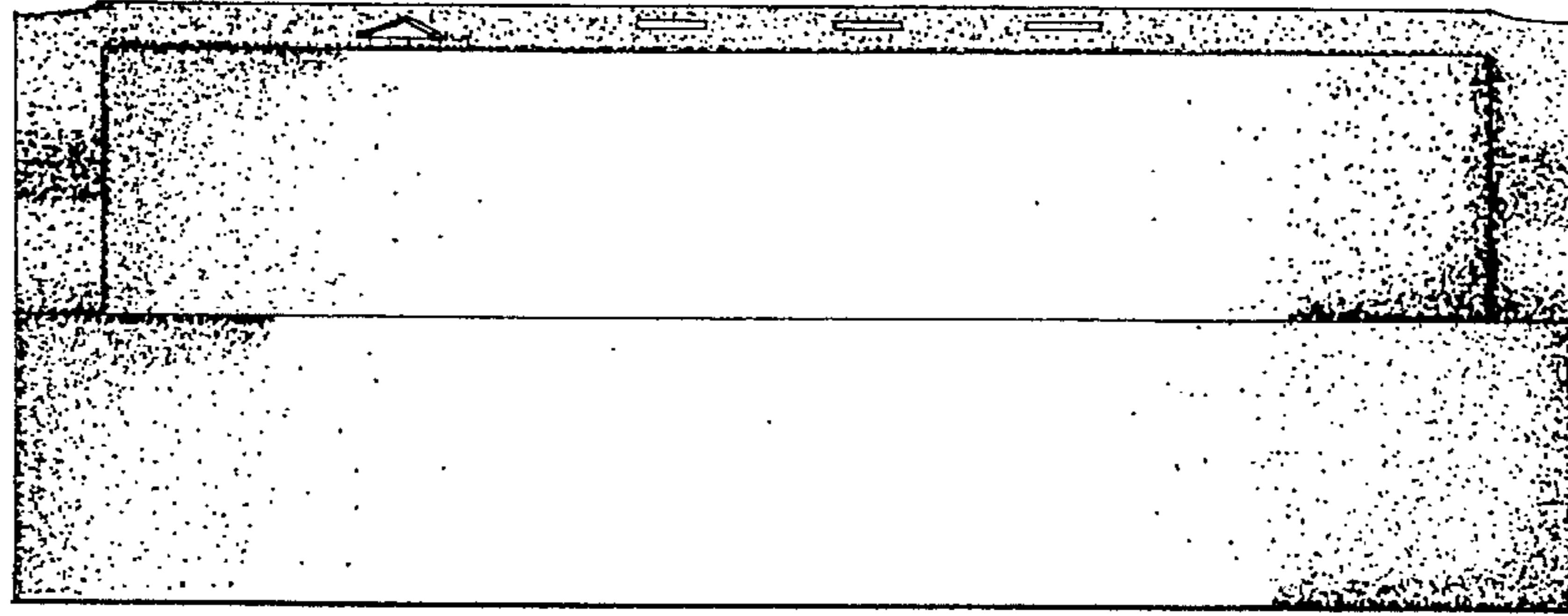

FIG. 4

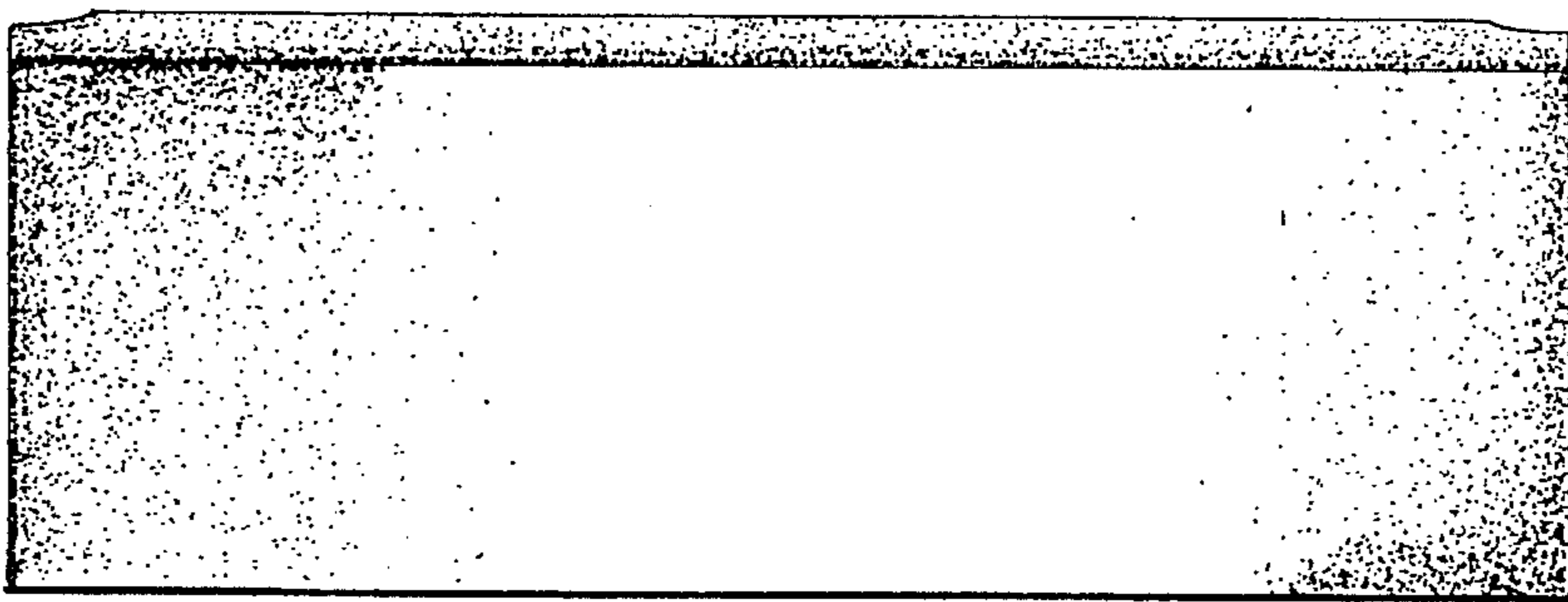

FIG. 5

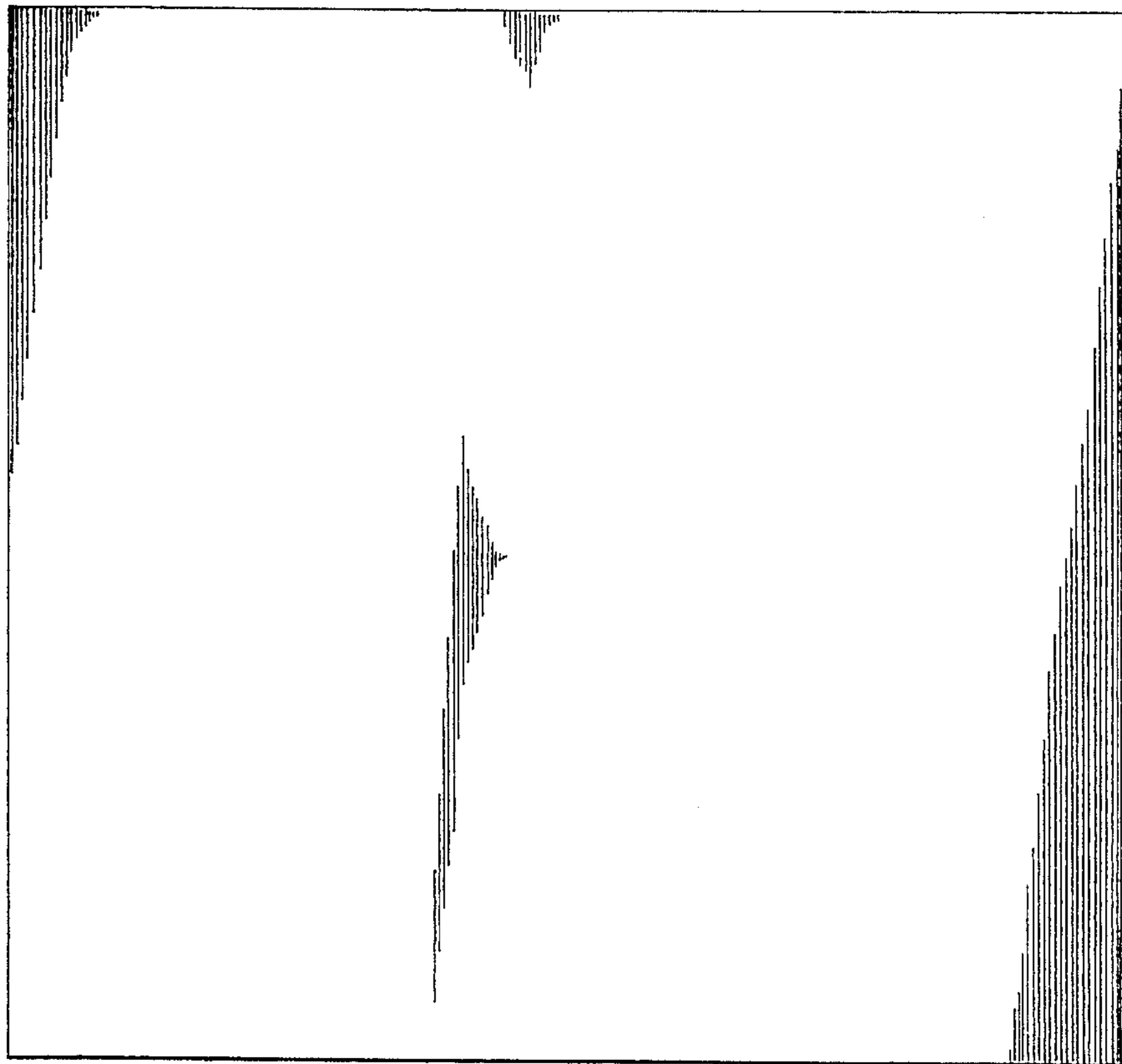

FIG. 6

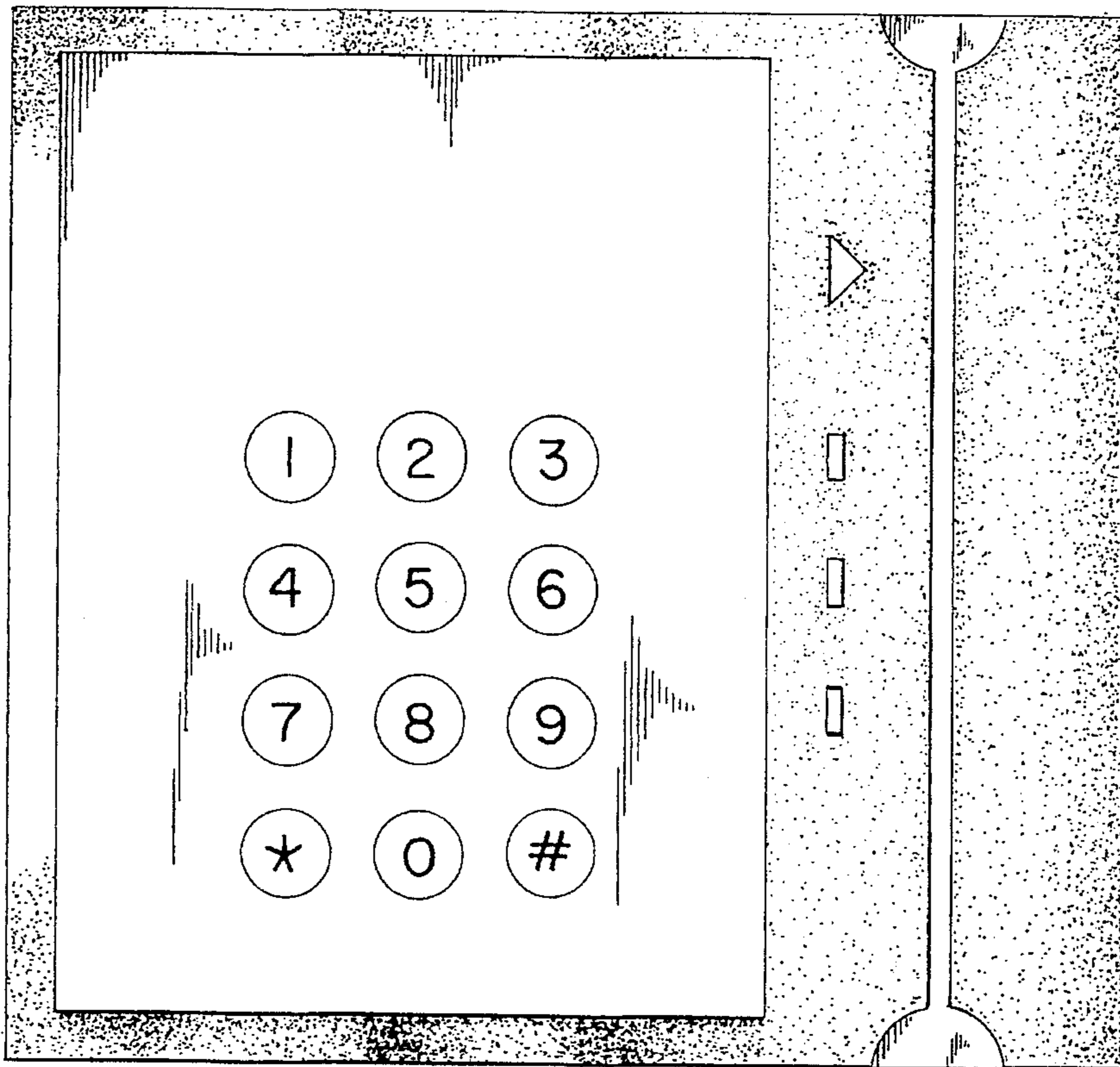

FIG. 7

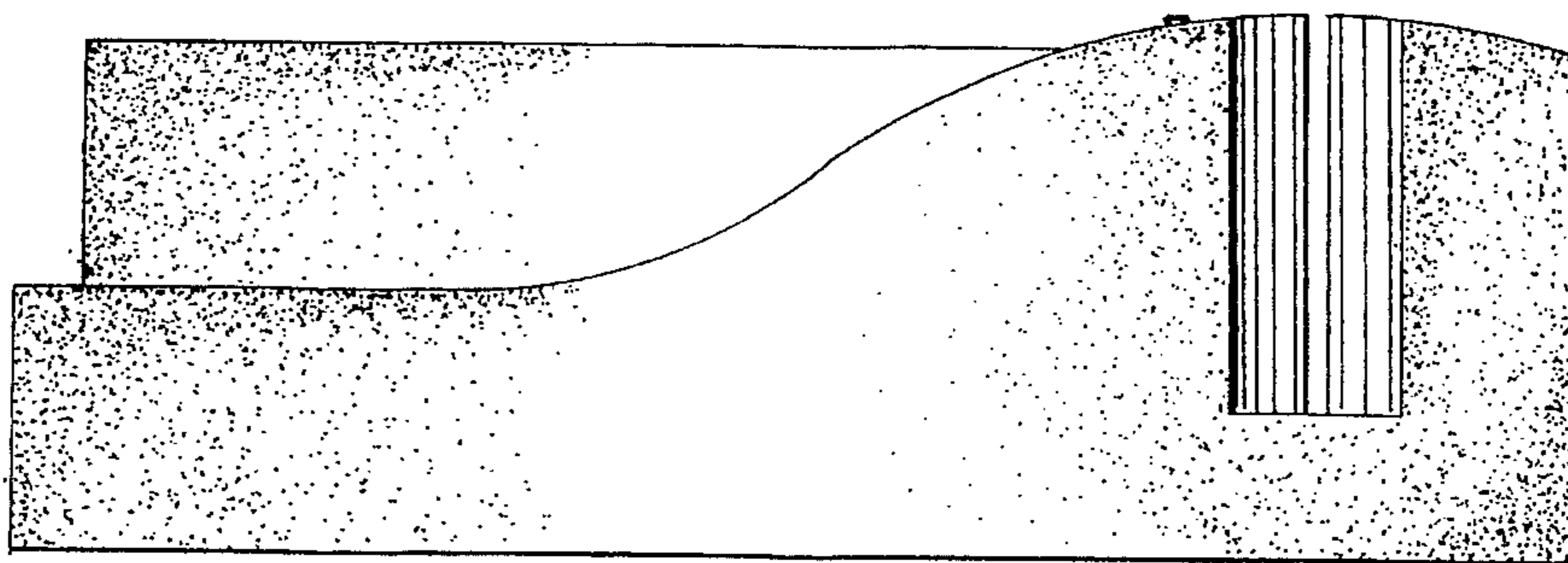

FIG. 8

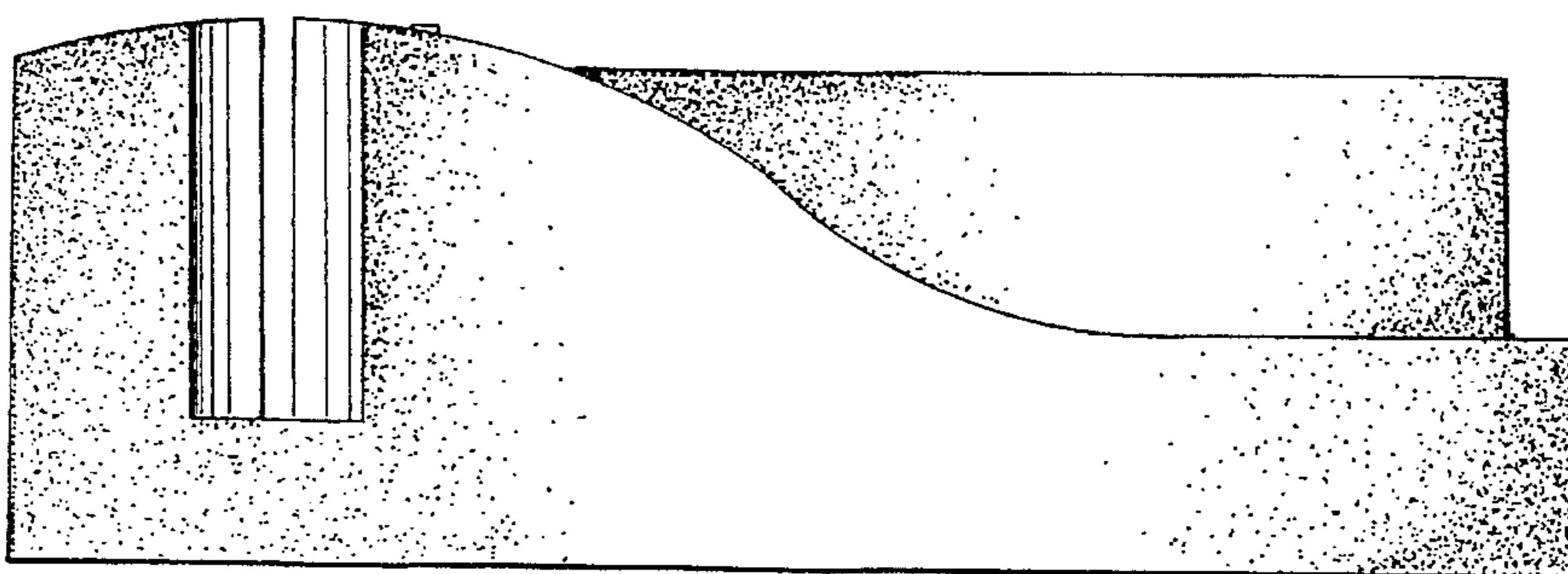

FIG. 9

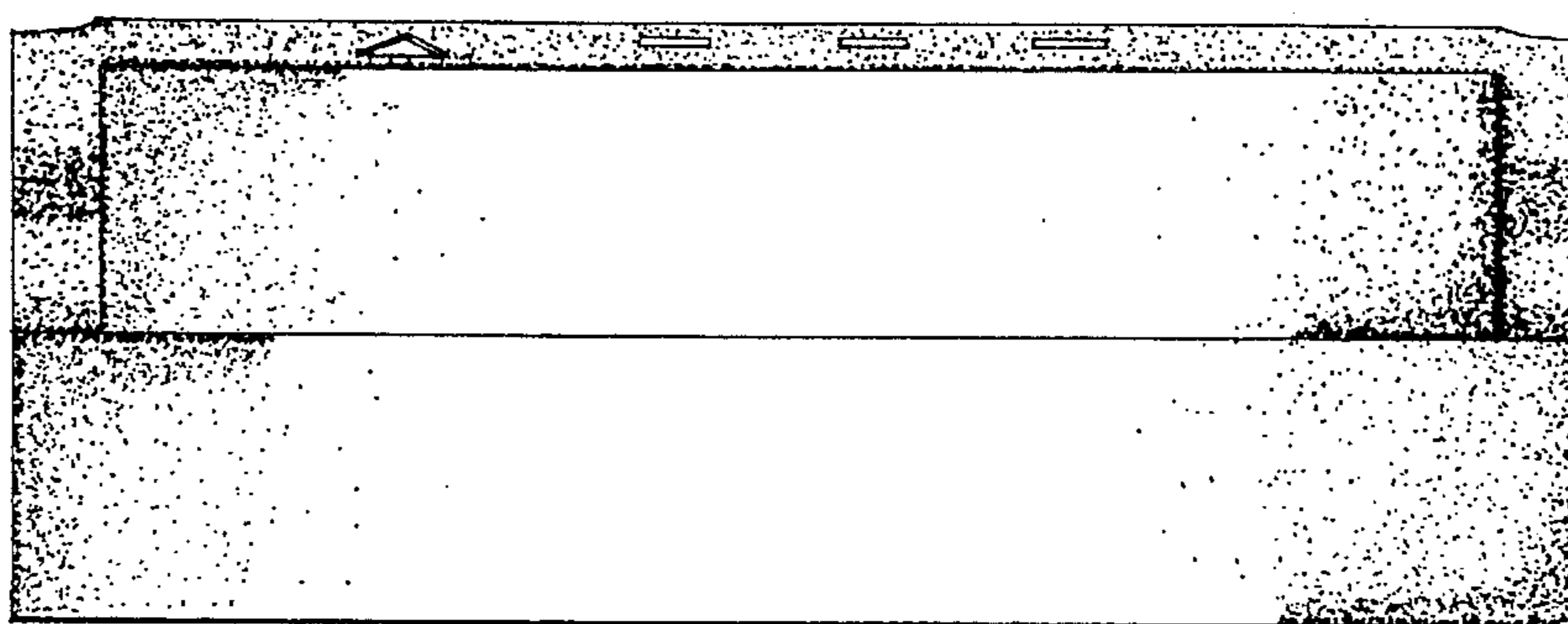

FIG. 10

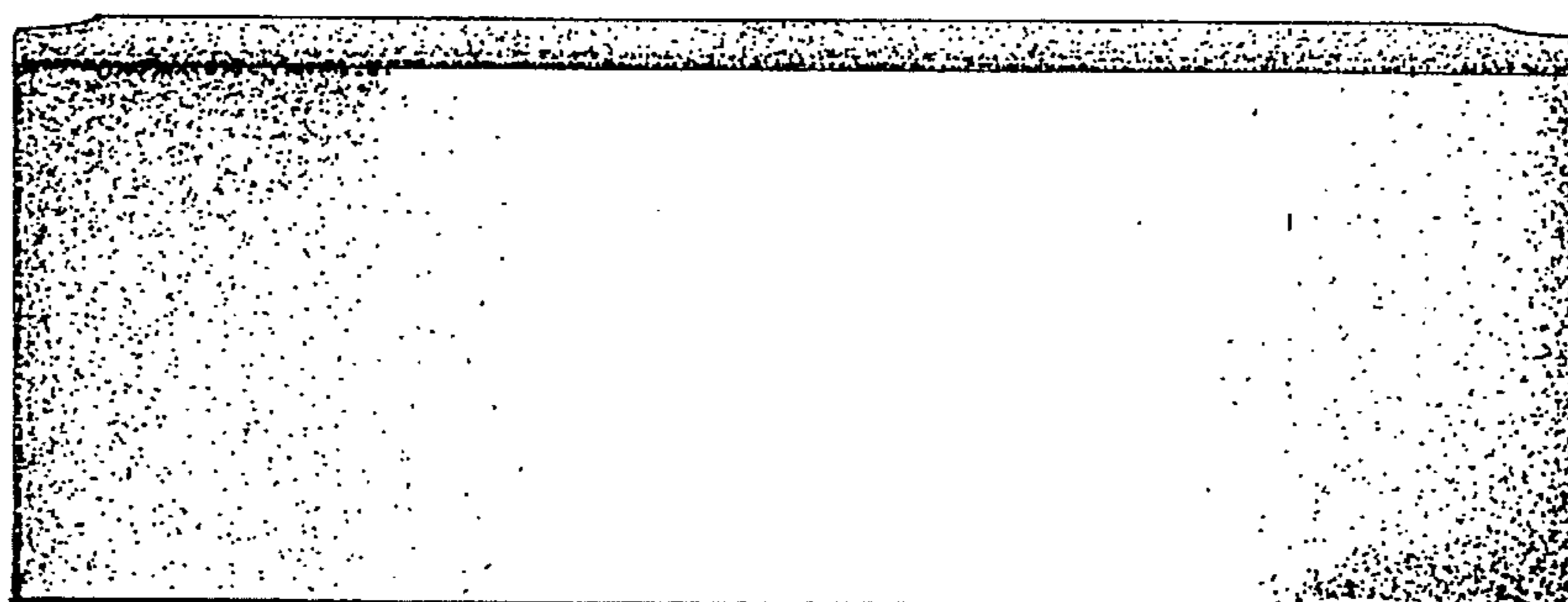

FIG. 11

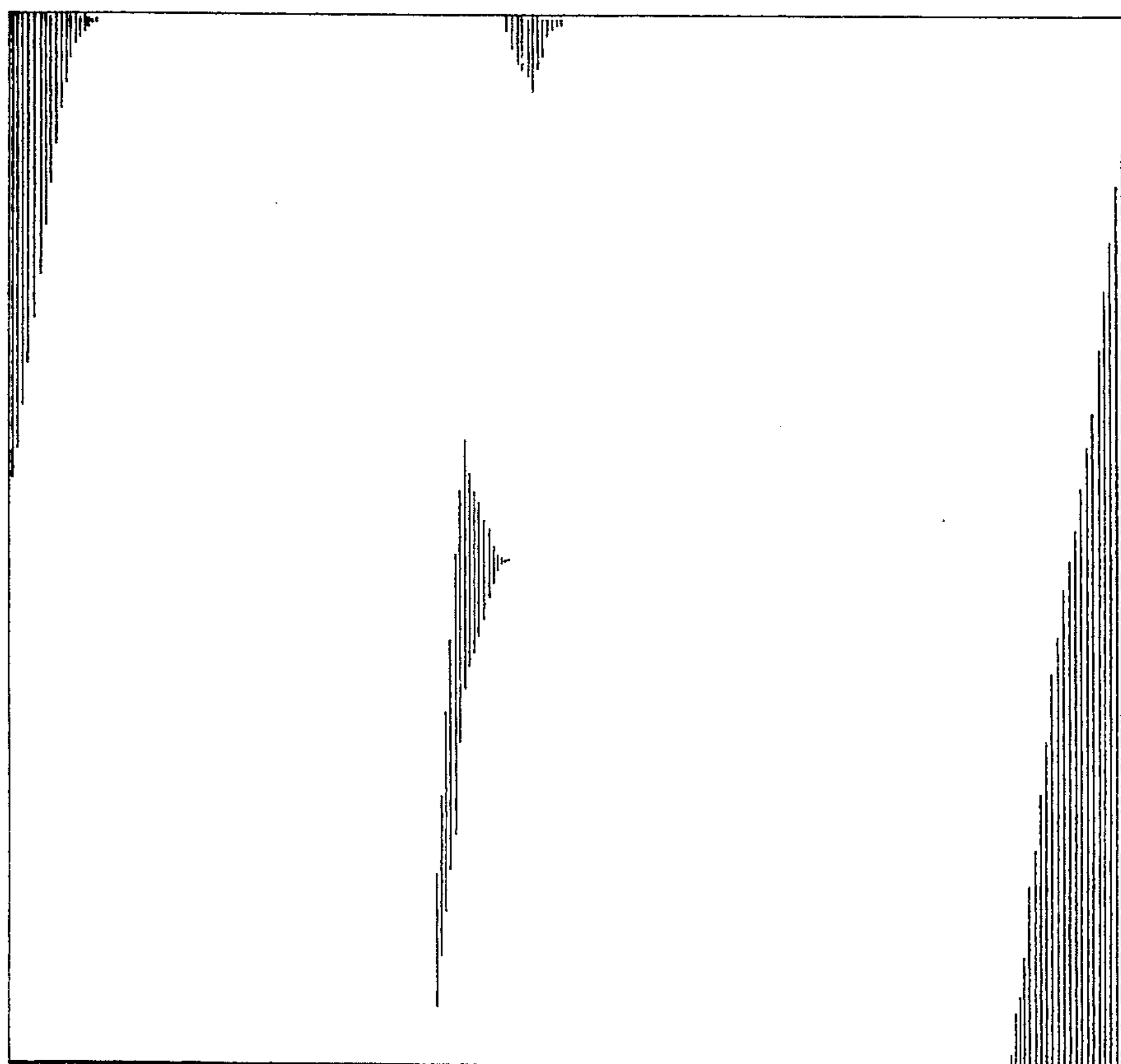

FIG. 12

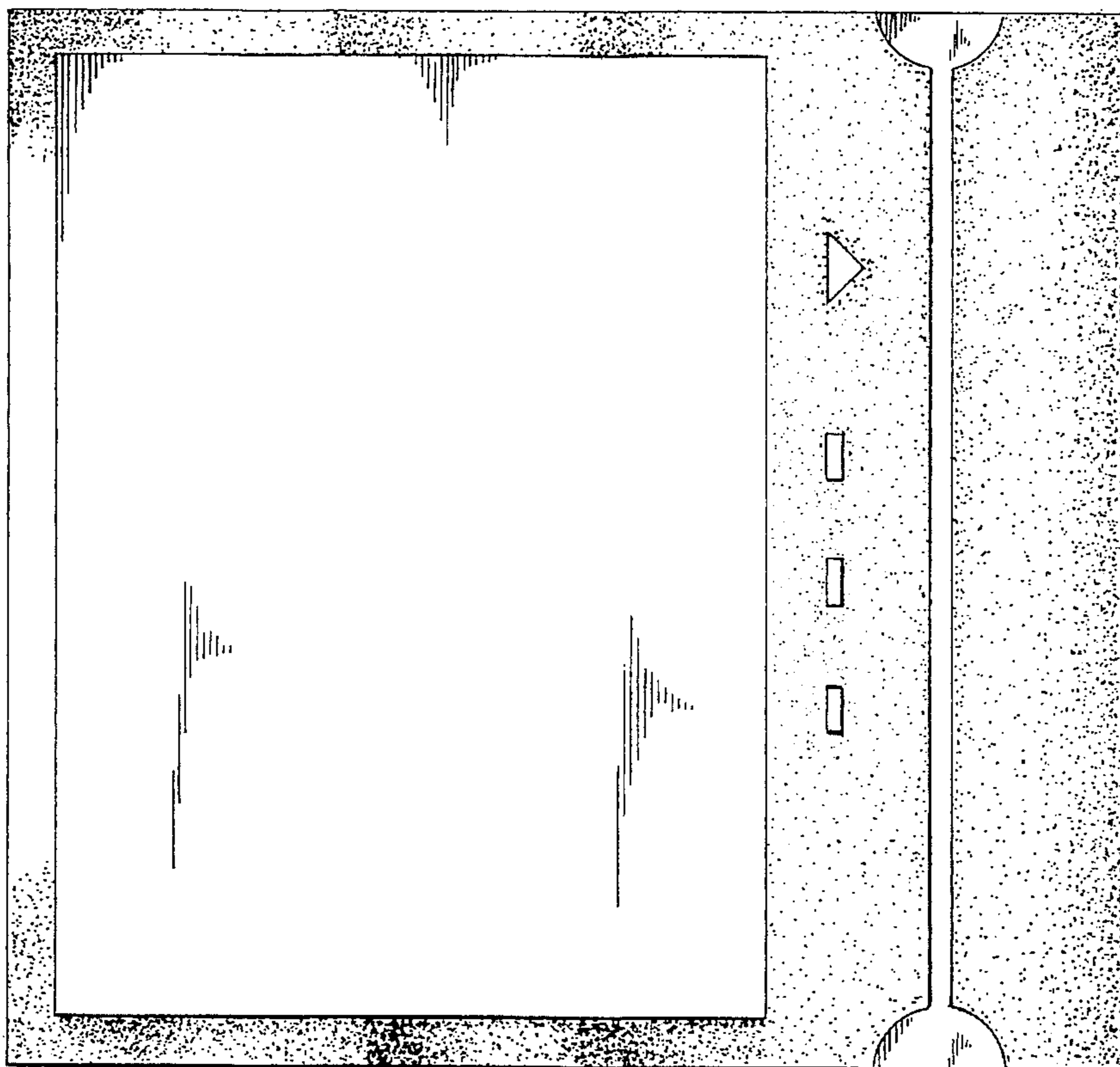

FIG. 13

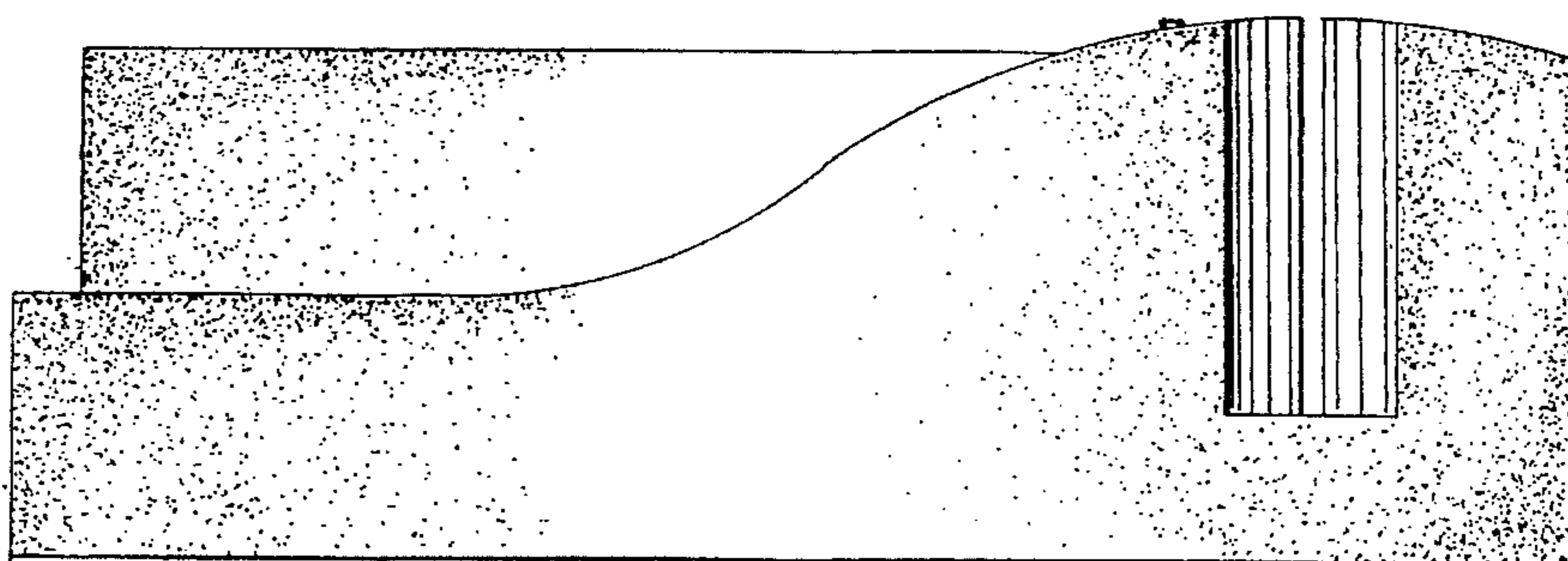

FIG. 14

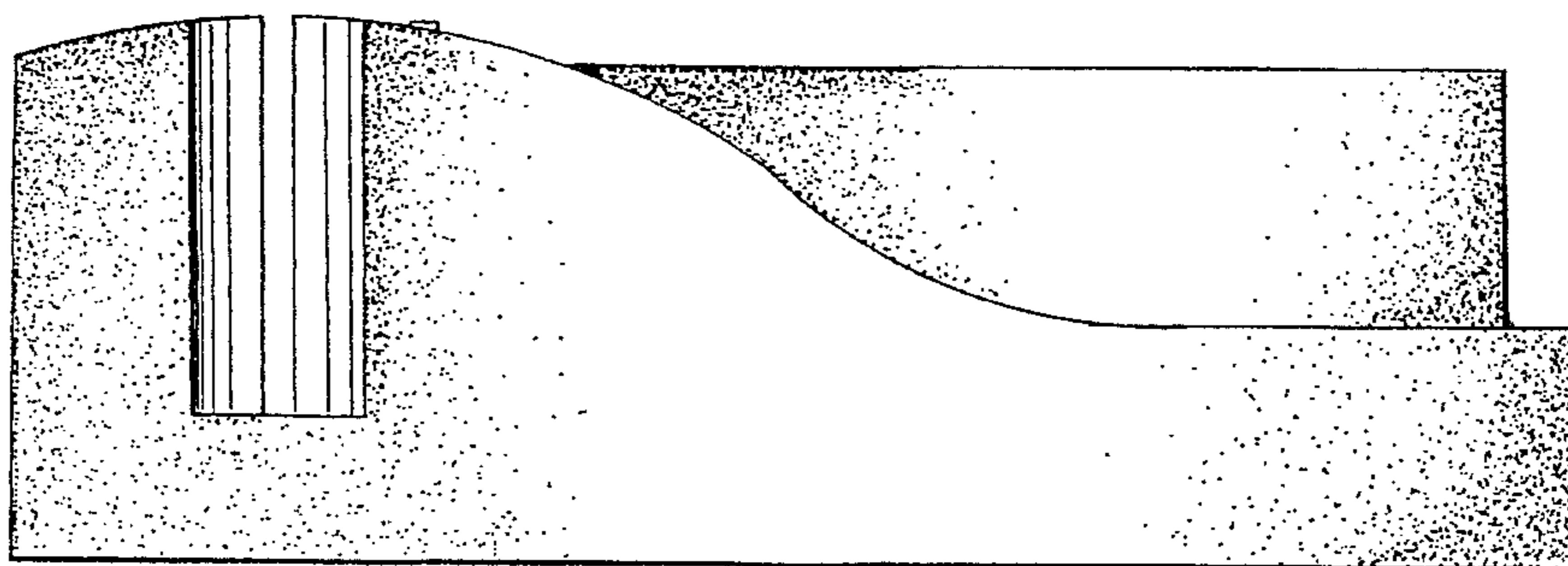

FIG. 15

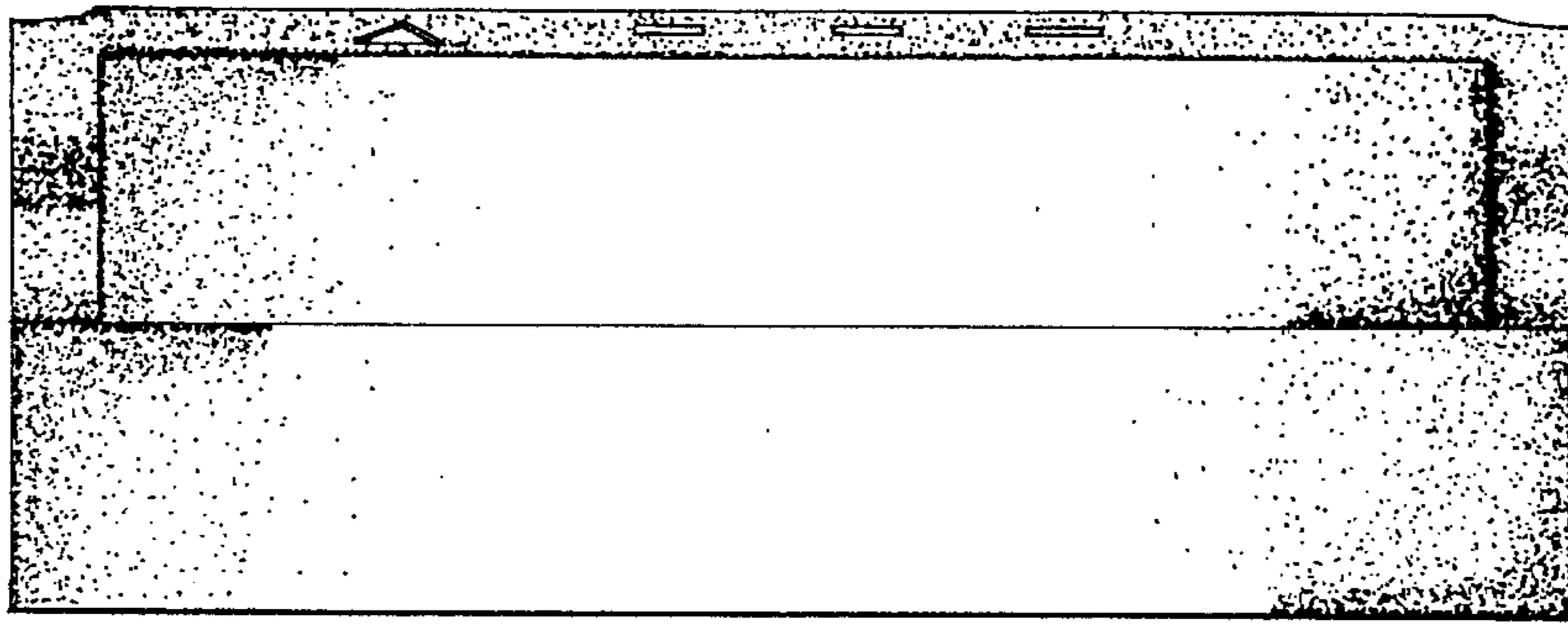

FIG. 16

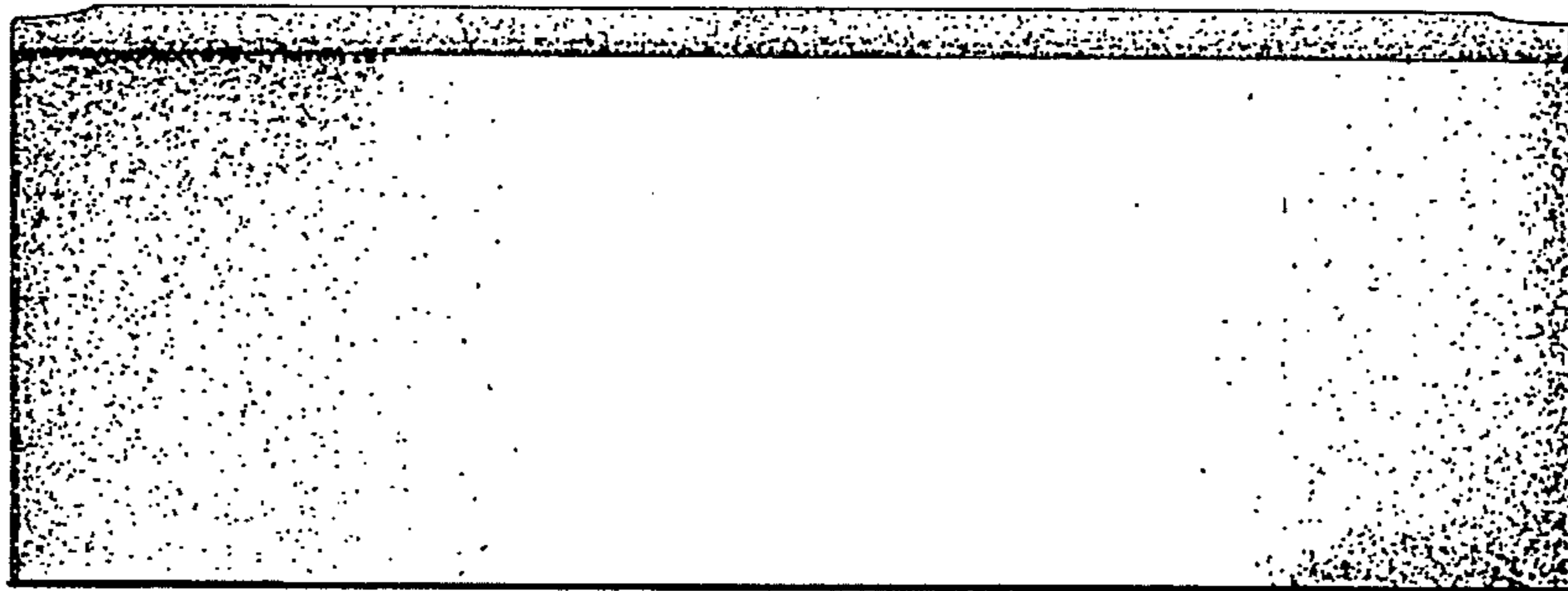

FIG. 17

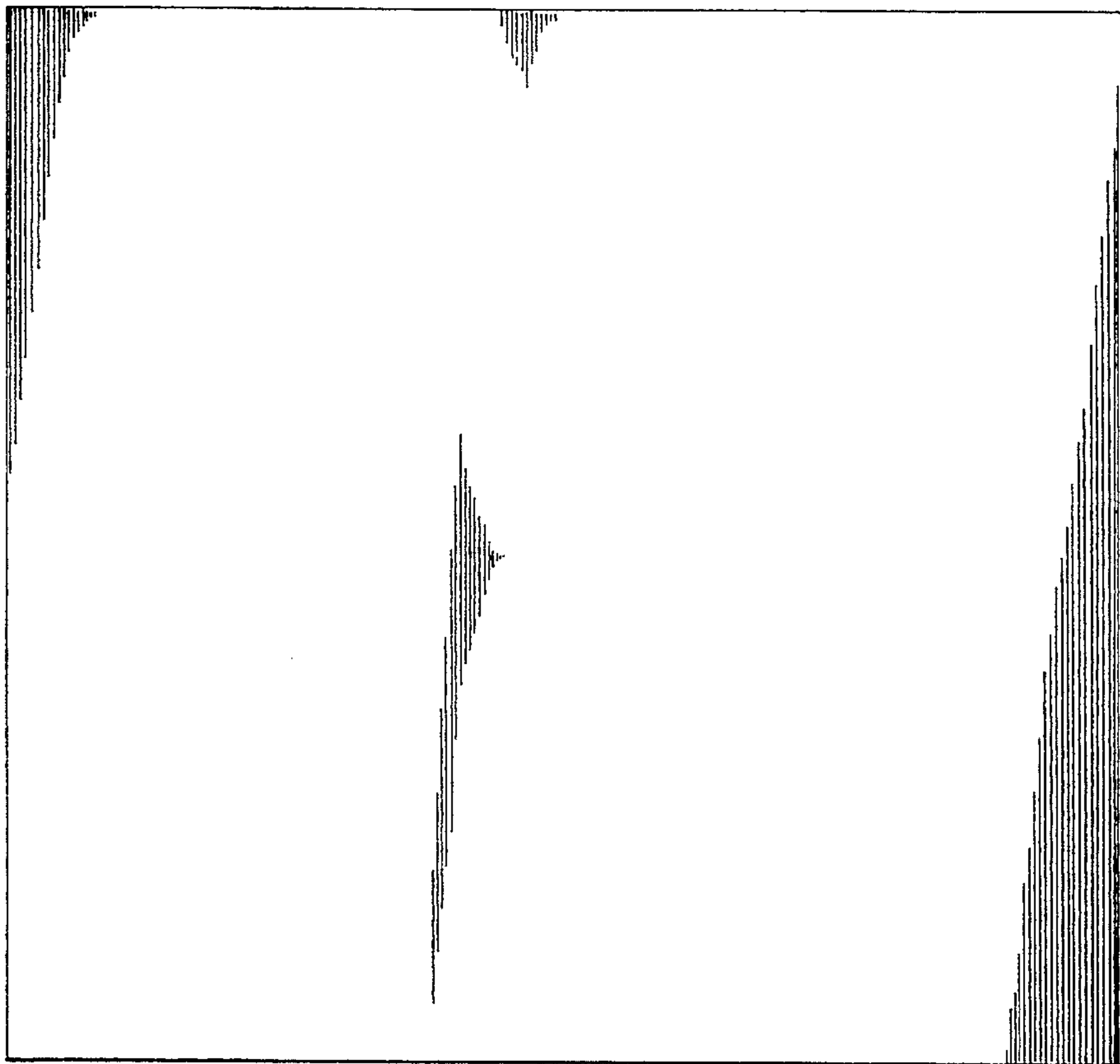

FIG. 18

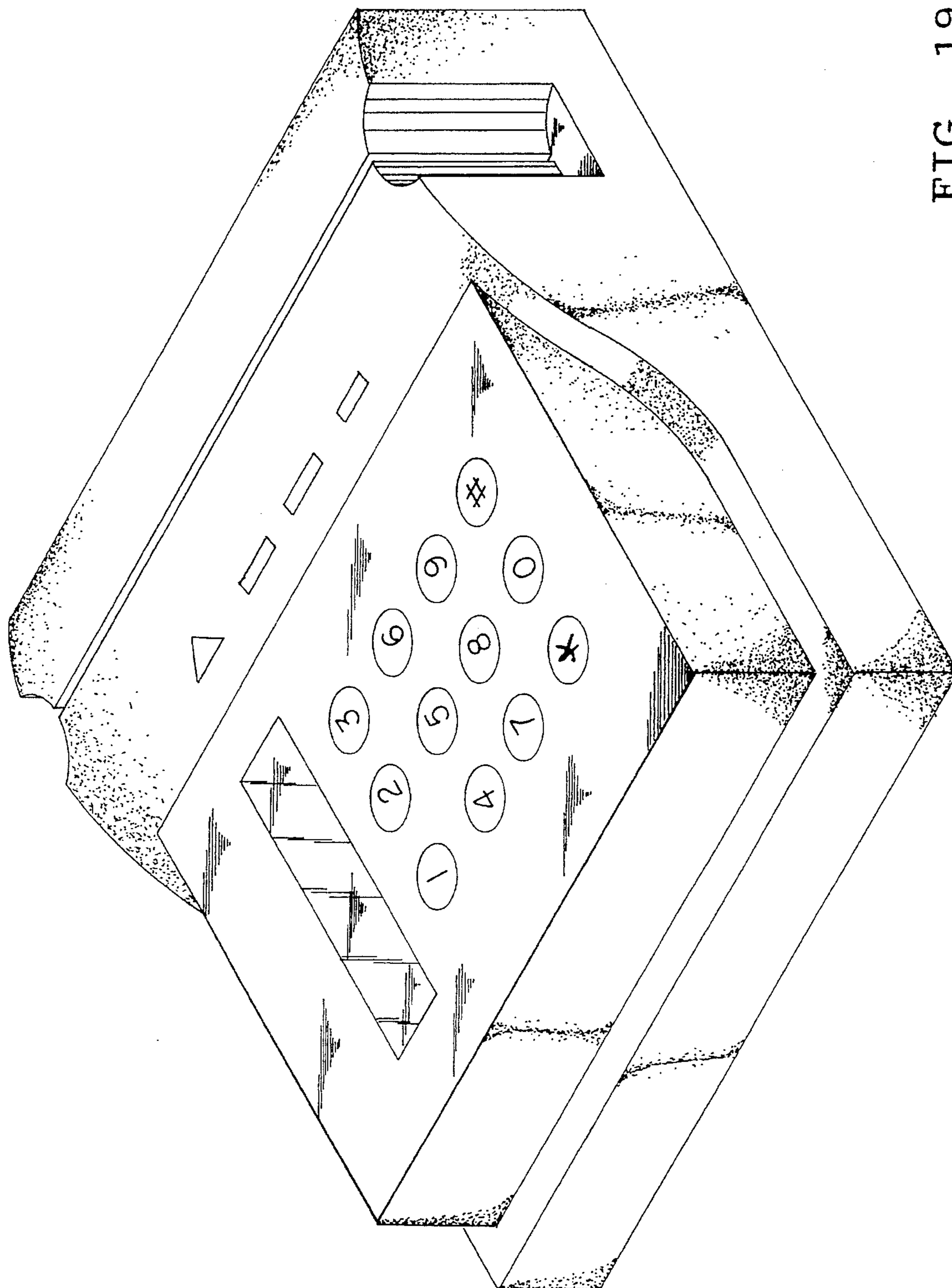

FIG. 19

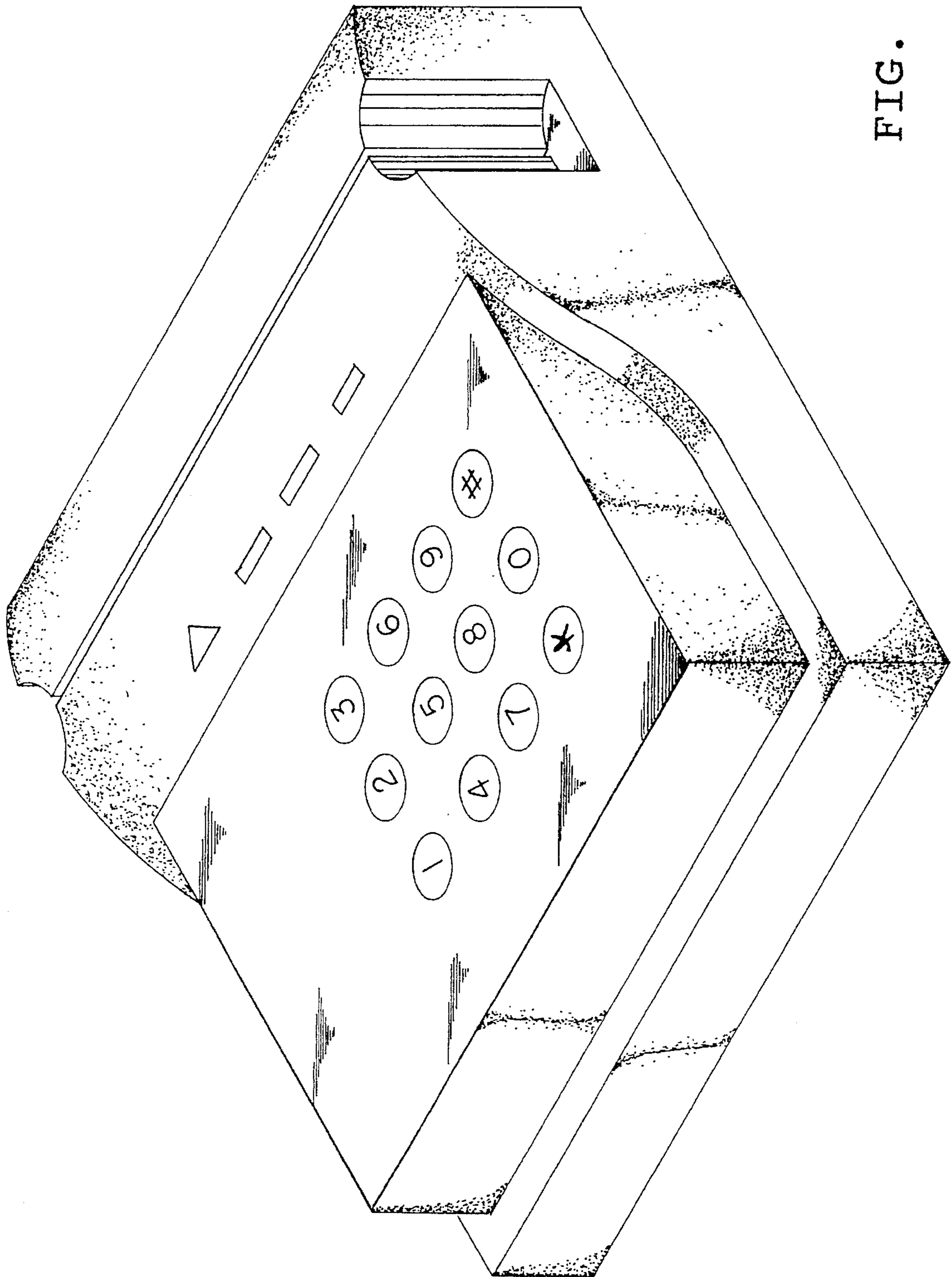

FIG. 20

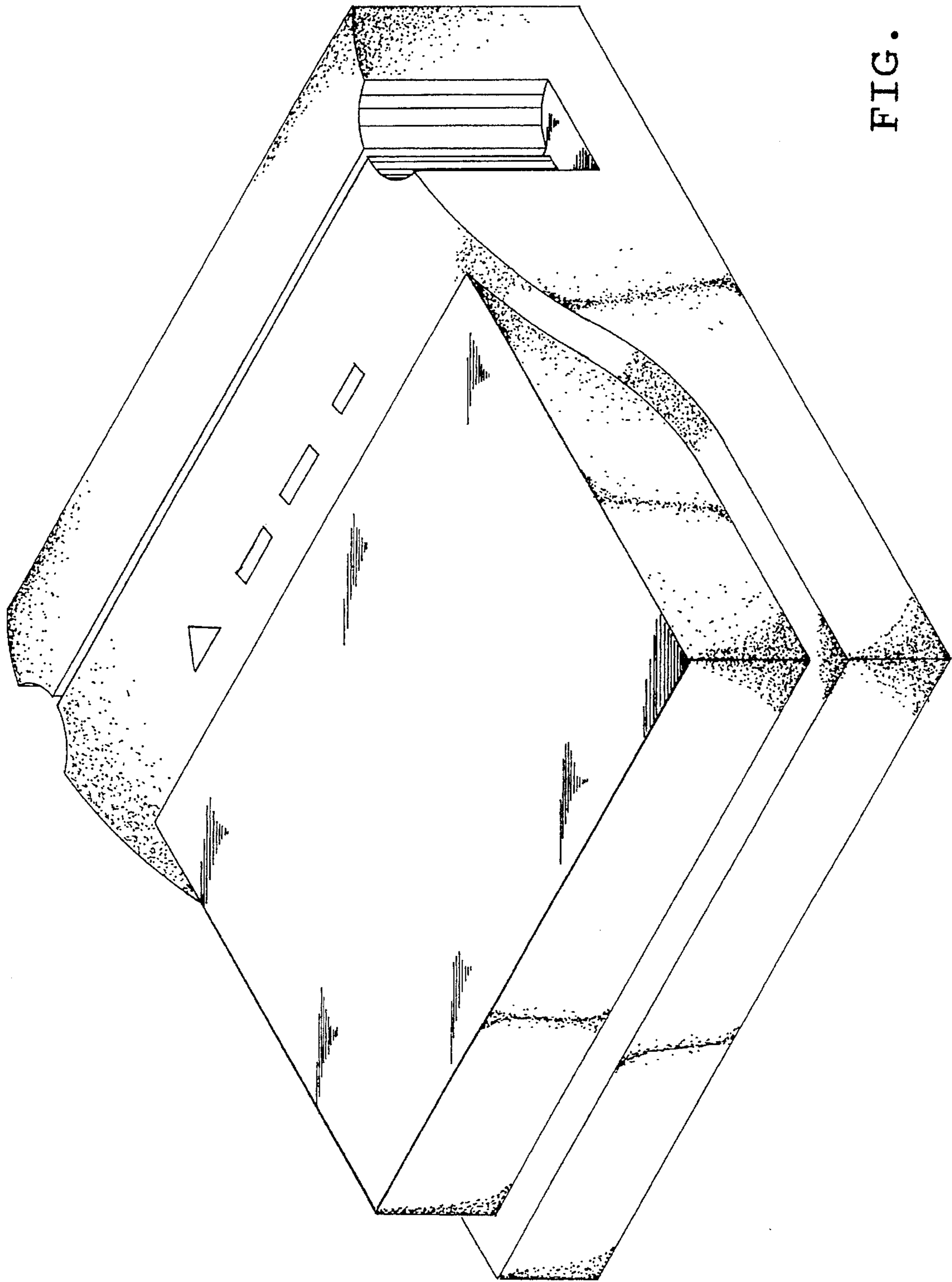

FIG. 21