



US00D371714S

United States Patent [19]

[11] Patent Number: **Des. 371,714**

Lewis

[45] Date of Patent: ****Jul. 16, 1996**

[54] POT

3,152,735 10/1964 Caldwell D7/598 X

[76] Inventor: **Paula Lewis**, P.O. Box 772, Little Rock, Ark. 72203

FOREIGN PATENT DOCUMENTS

398611 1/1909 France D7/361 X

[**] Term: **14 Years**

OTHER PUBLICATIONS

[21] Appl. No.: **40,423**

Pot w/Handle and Lid, HFD, Mar. 29, 1982.
Pot (left) Schöner Wohnen Oct. 1984, p. 132.

[22] Filed: **Jun. 19, 1995**

[52] U.S. Cl. **D7/318; D7/316; D7/361**

[58] Field of Search D7/590, 598, 310, D7/604, 606, 623, 300, 303, 302, 312, 314, 316, 317, 318, 319, 320, 321, 222, 672, 360, 361, 354; D24/121, 123, 122; 222/465.1, 475.1

Primary Examiner—M. N. Pandozzi
Attorney, Agent, or Firm—Stephen D. Carver; Trent C. Keisling

[57] CLAIM

The ornamental design for a pot, as shown and described.

DESCRIPTION

[56] References Cited

U.S. PATENT DOCUMENTS

D. 10,312	11/1877	Jeffords	D7/317
D. 38,112	7/1906	Allen	D7/318
D. 50,595	4/1917	Wagner	D7/317 X
D. 154,946	8/1949	Moeller	D24/123
D. 185,416	6/1959	Douglas	D7/318 X
D. 259,011	4/1981	Daentn	D7/318
D. 342,642	12/1993	Brazis et al.	D7/316 X
D. 342,784	12/1993	Passiak et al.	D24/123
2,466,142	4/1949	Yost	D24/123 X
2,948,522	8/1960	Peters	D7/316 X

FIG. 1 is a rear, top perspective view of a pot showing my new design;
FIG. 2 is a side, top perspective view thereof;
FIG. 3 is a rear elevational view thereof;
FIG. 4 is a side elevational view thereof, with the opposite side being a mirror image;
FIG. 5 is a front elevational view thereof;
FIG. 6 is a bottom plan view thereof; and,
FIG. 7 is a top plan view thereof.

1 Claim, 1 Drawing Sheet

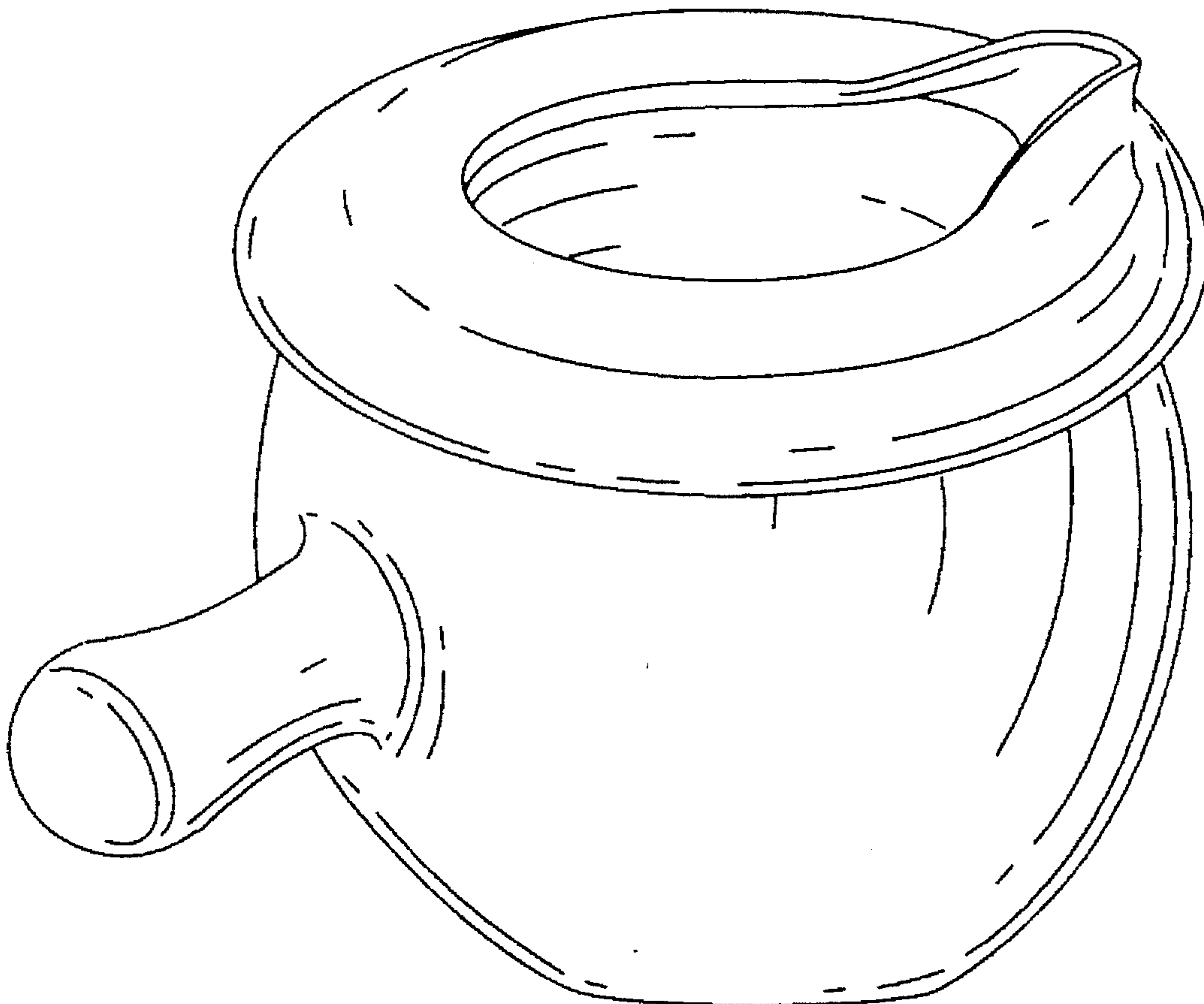

FIG. 1

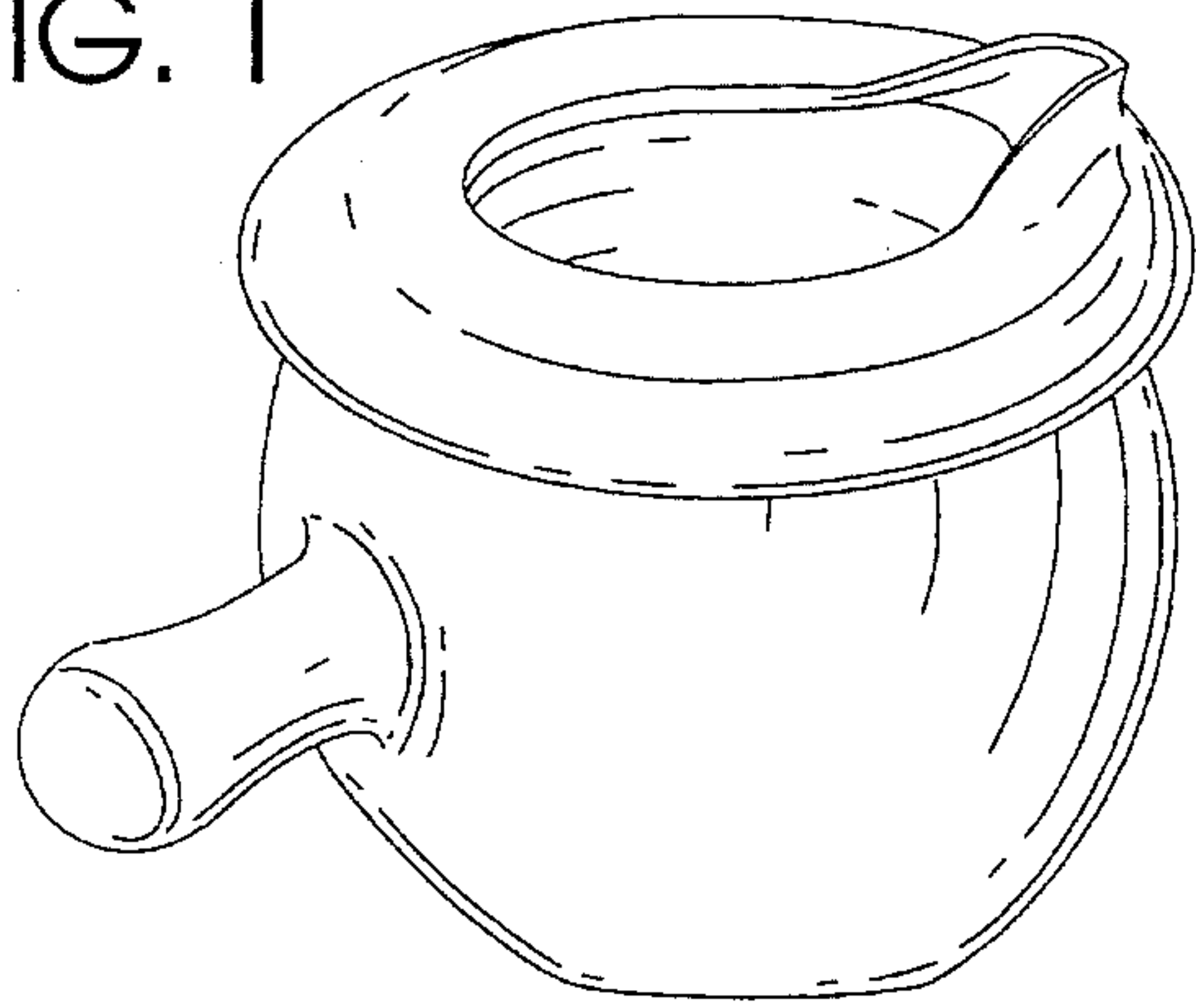

FIG. 2

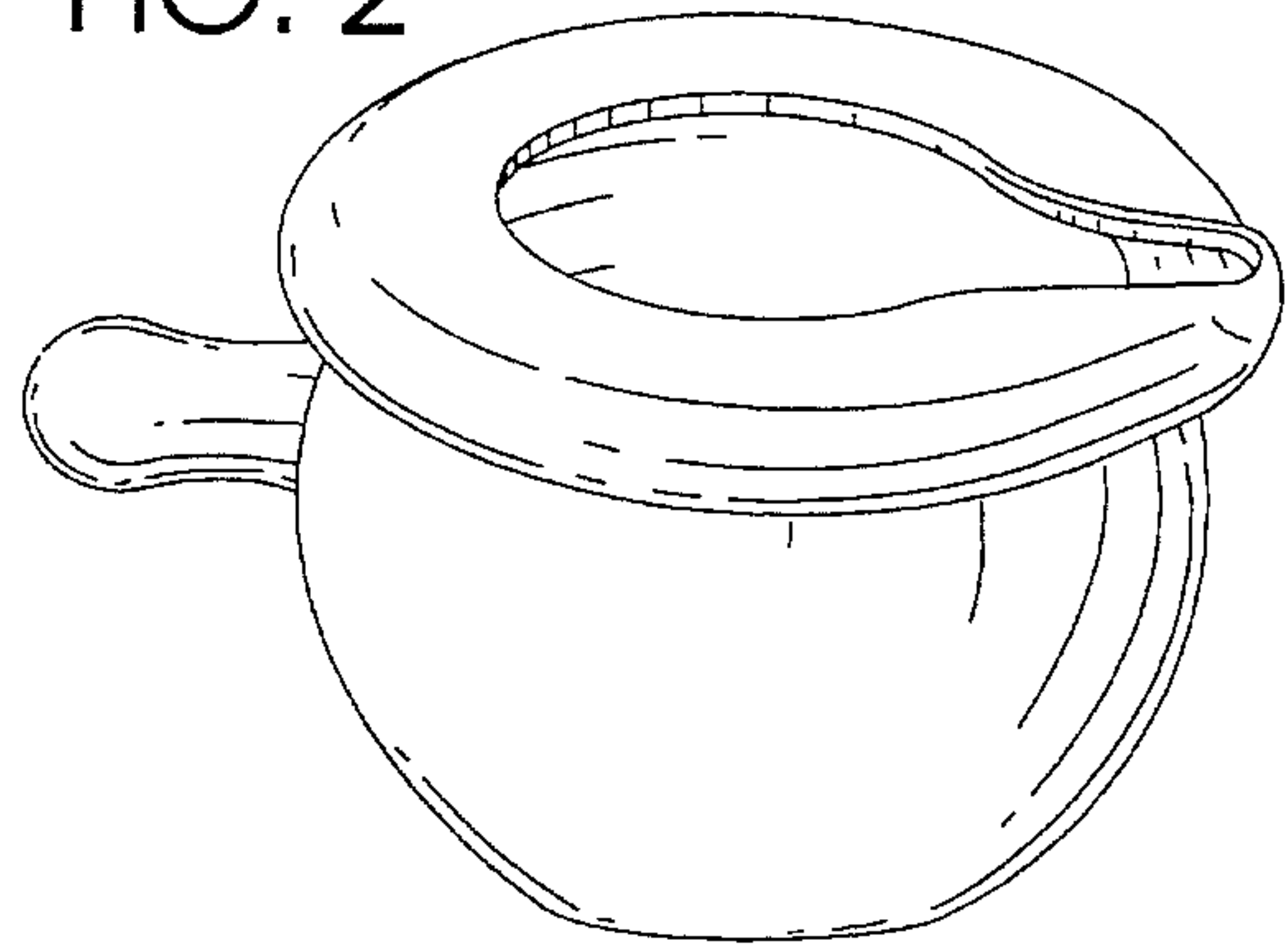

FIG. 3

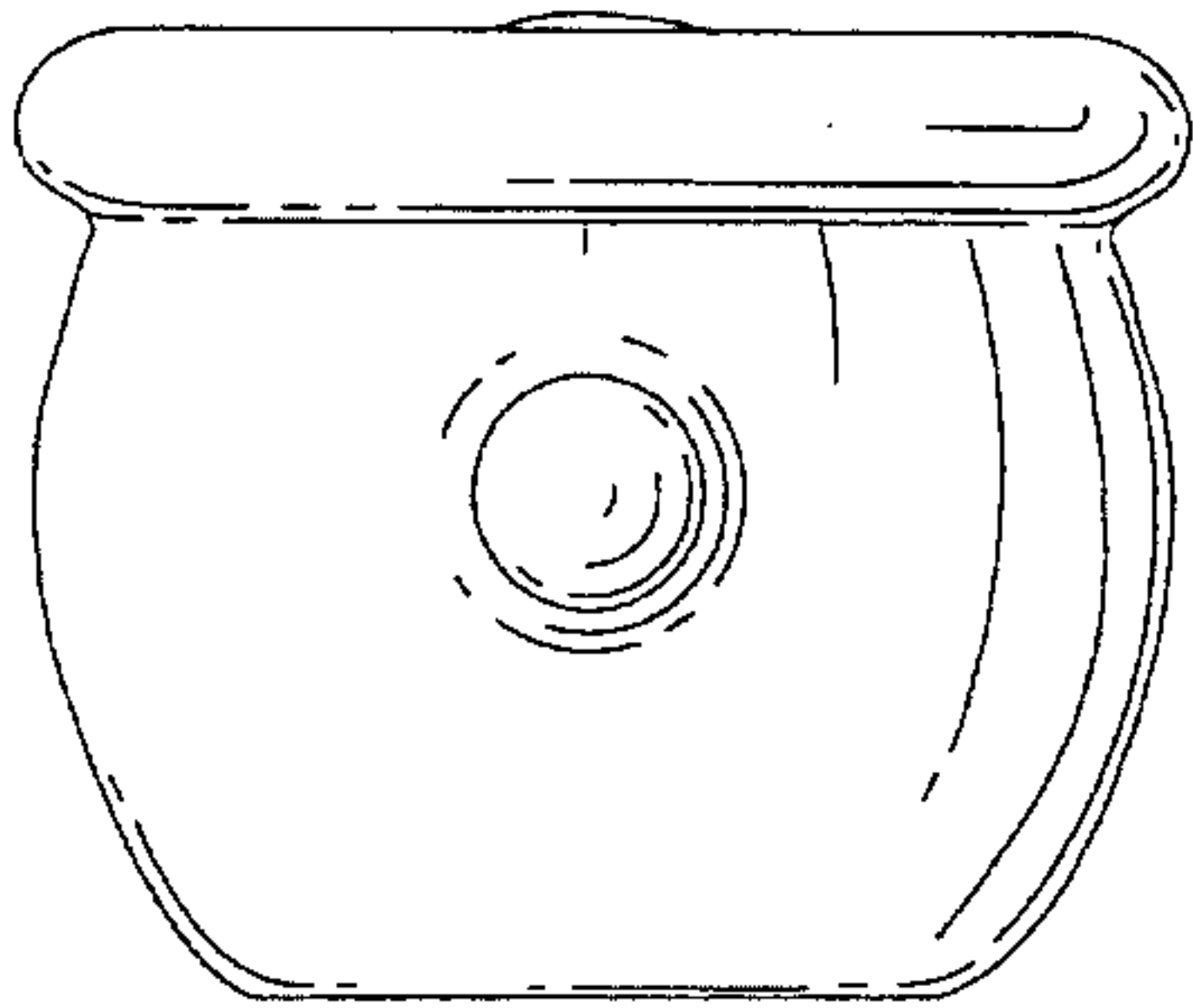

FIG. 4

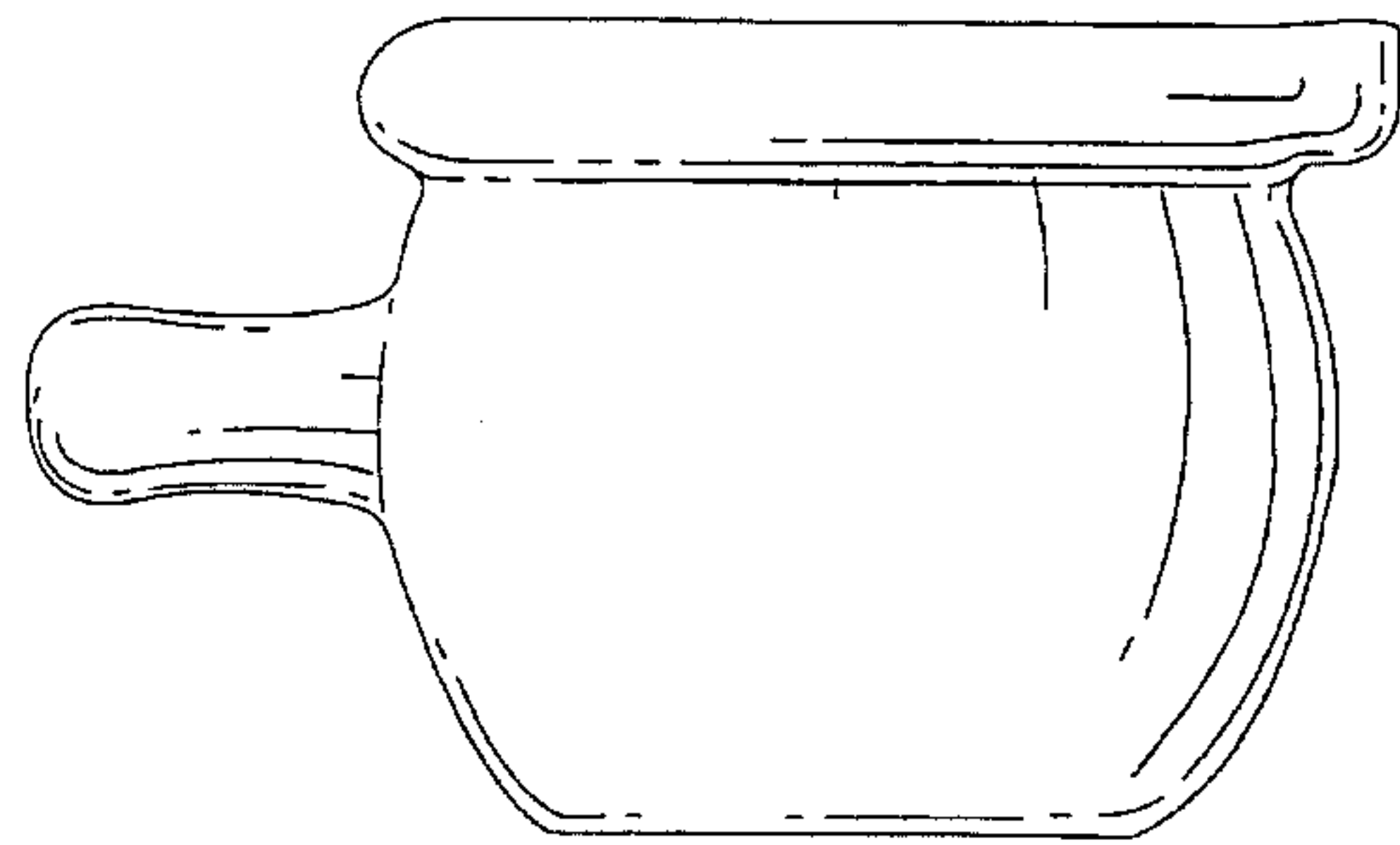

FIG. 5

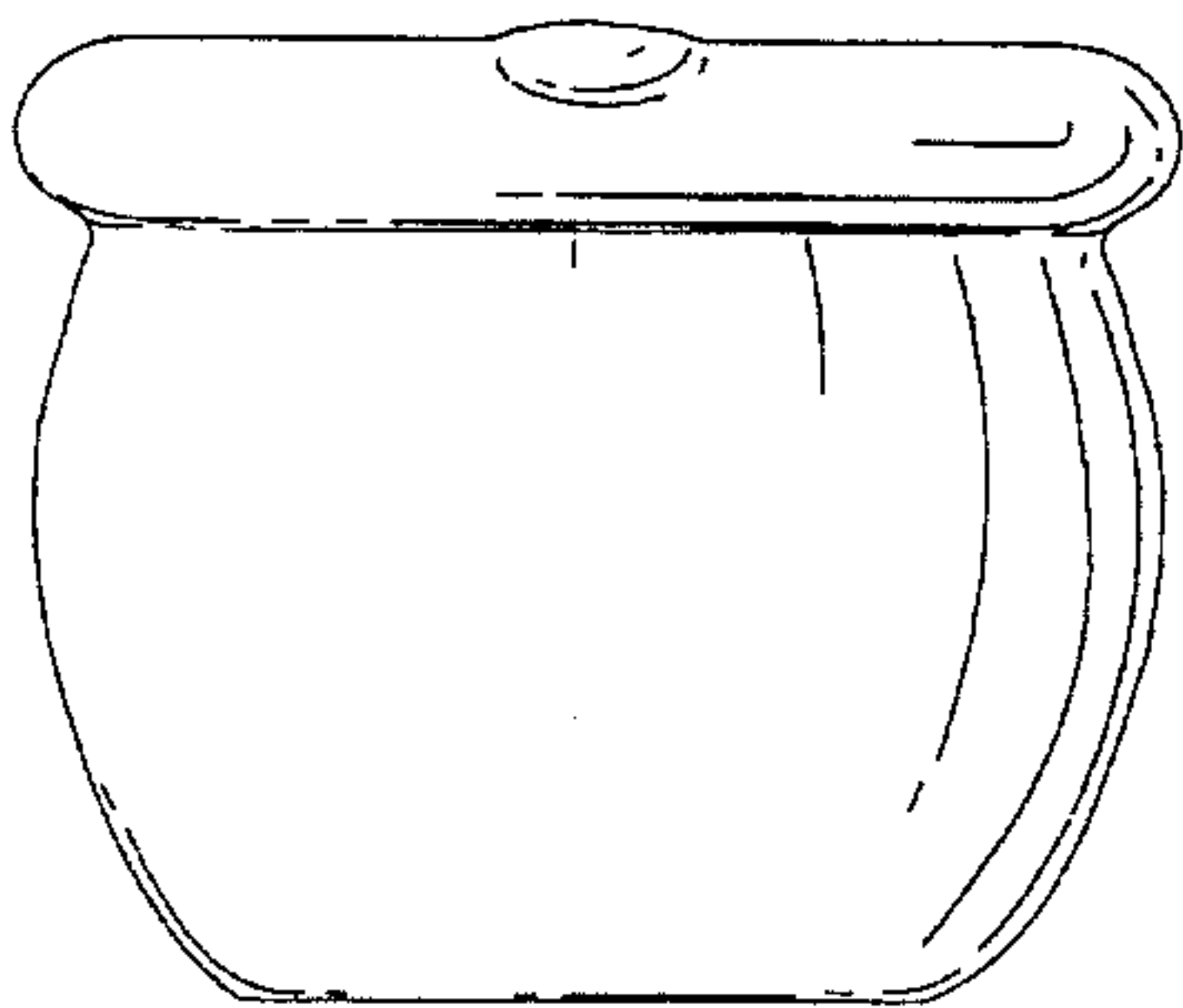

FIG. 6

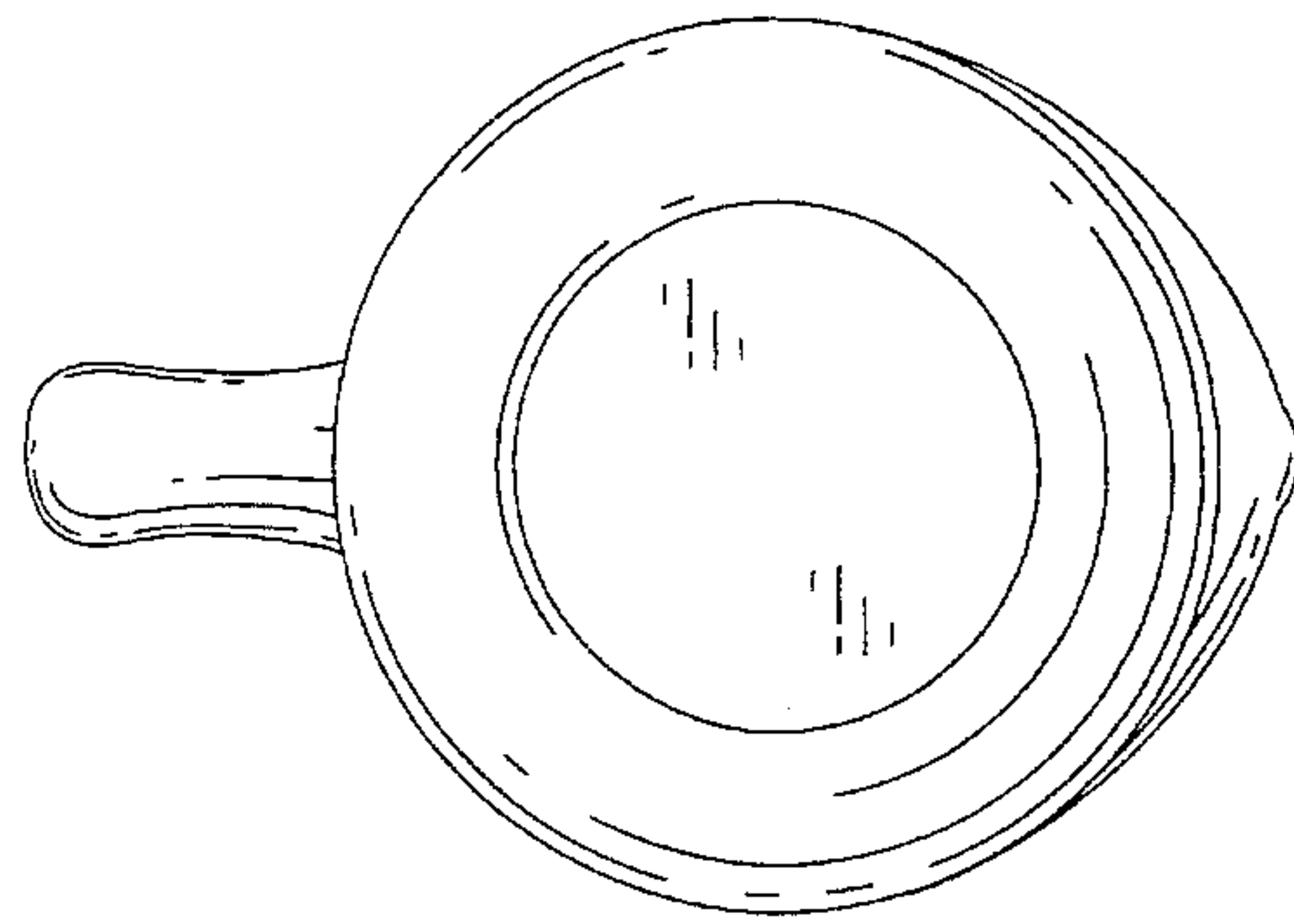

FIG. 7

