



US00D371678S

United States Patent [19]

[11] Patent Number: **Des. 371,678**

Borghorst et al.

[45] Date of Patent: ****Jul. 16, 1996**

[54] **COMBINED LID AND PACKAGE FOR CONTACT LENSES**

D. 330,885	11/1992	Demopoulos et al.	D9/341
D. 357,579	4/1995	Abrams et al.	D3/264
D. 358,025	5/1995	Martin et al.	D3/264
D. 358,028	5/1995	Abrams et al.	D3/264

[75] Inventors: **Sharla Borghorst**, Frankfurt am Main; **Erich Baumann**, Goldbach; **John Golby**, Aschaffenburg; **Peter Hagmann**, Erlenbach am Main; **Peter Herbrechtsmeier**, Königstein; **Otto Kretzschmar**, Einhausen; **Bernhard Seiferling**, Goldbach, all of Germany; **Michele De Lucchi**, Angera, Italy; **Torsten Fritze**, Milan, Italy; **Masahiko Cubo**, Milan, Italy

Primary Examiner—Celia Murphy
Attorney, Agent, or Firm—Edward M. Roberts; R. Scott Meece

[73] Assignee: **Ciba-Geigy Corporation**, Tarrytown, N.Y.

[**] Term: **14 Years**

[21] Appl. No.: **30,332**

[22] Filed: **Oct. 27, 1994**

[52] U.S. Cl. **D3/264; D3/263**

[58] **Field of Search** **D3/201, 263, 264; D9/341, 415; D16/134, 136; 206/822, 5.1, 316.1, 205**

[57] **CLAIM**

The ornamental design for a combined lid and package for contact lenses, as shown and described.

DESCRIPTION

FIG. 1 is a top perspective view of a combined lid and package for contact lenses showing our new design, the lid being removed;
FIG. 2 is a bottom perspective view thereof;
FIG. 3 is a top plan view thereof;
FIG. 4 is a bottom plan view thereof;
FIG. 5 is a right side elevational view thereof;
FIG. 6 is a left side elevational view thereof;
FIG. 7 is a front elevational view thereof;
FIG. 8 is a rear elevational view thereof;
FIG. 9 is a top perspective view thereof, the lid shown partially opened;
FIG. 10 is a top perspective view of FIG. 9, the lid shown in a fully closed position;
FIG. 11 is a sectional view taken along line XI—XI of FIG. 4; and,
FIG. 12 is a section view taken on line XII—XII of FIG. 4.

[56] **References Cited**

U.S. PATENT DOCUMENTS

D. 142,116	8/1945	Parsons et al.	D9/345
D. 273,765	5/1984	Cillario	D9/341
D. 299,085	12/1988	Martinez	D3/264
D. 330,331	10/1992	Hsiao	D9/341

1 Claim, 5 Drawing Sheets

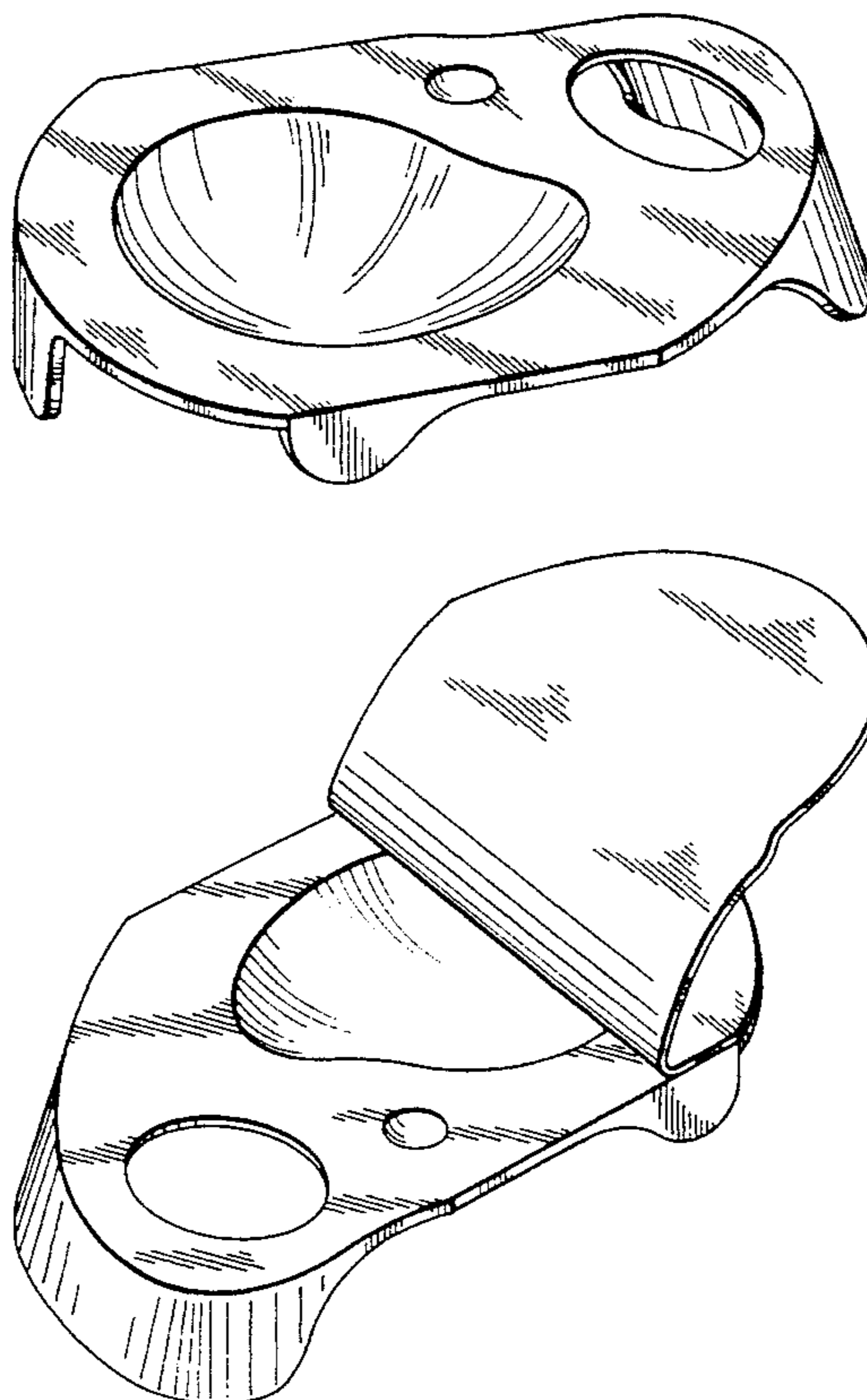

Fig. 1

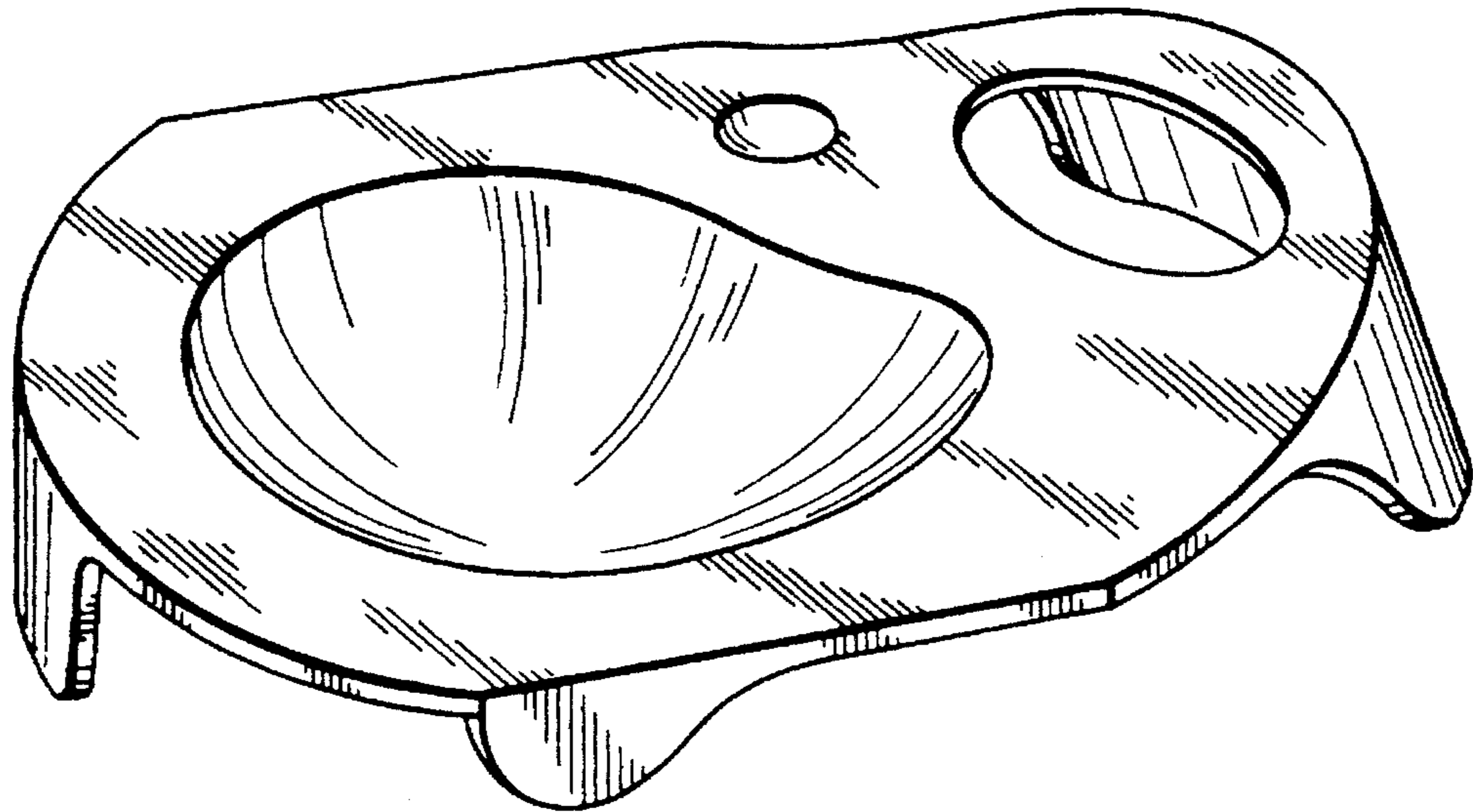

Fig. 2

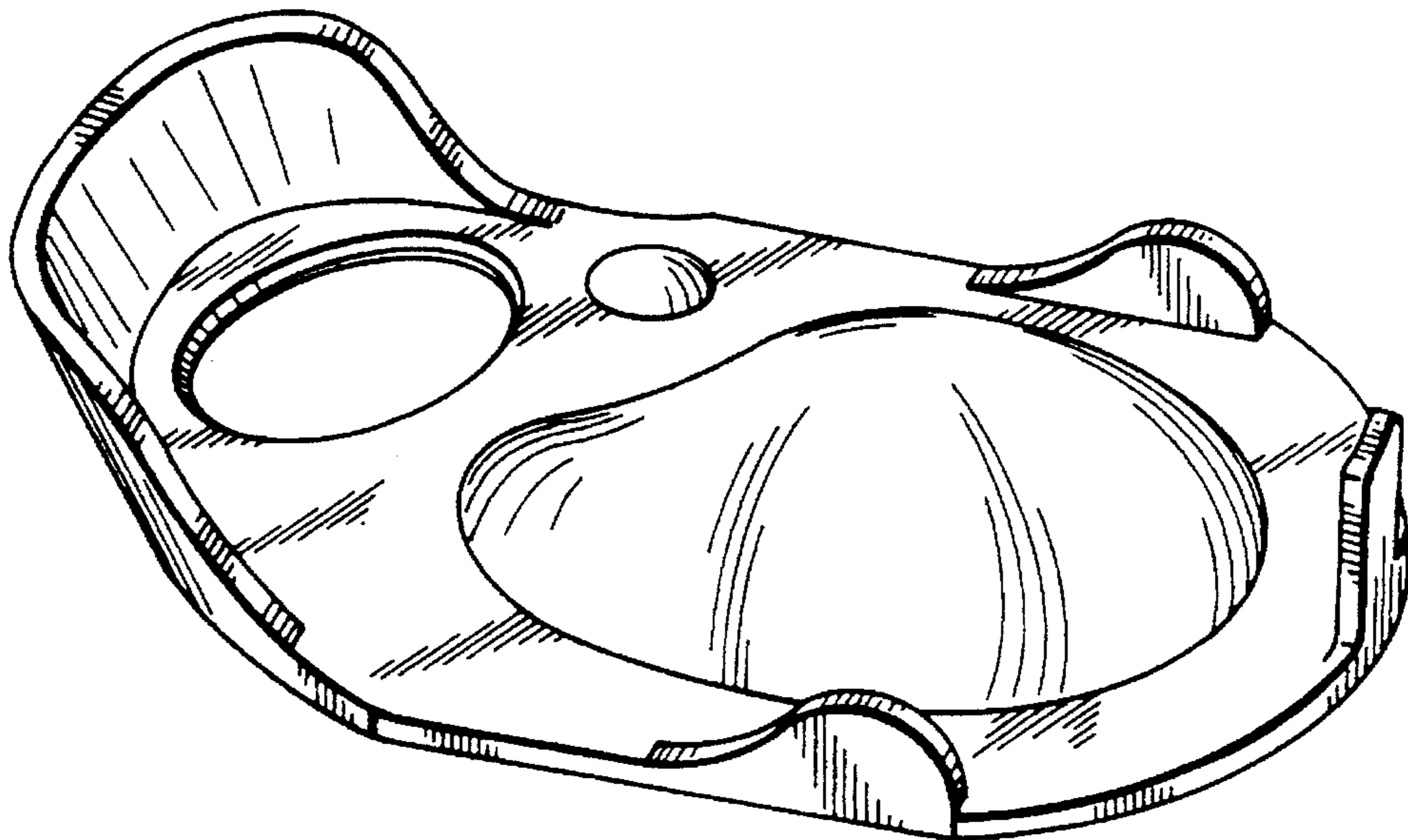

Fig. 3

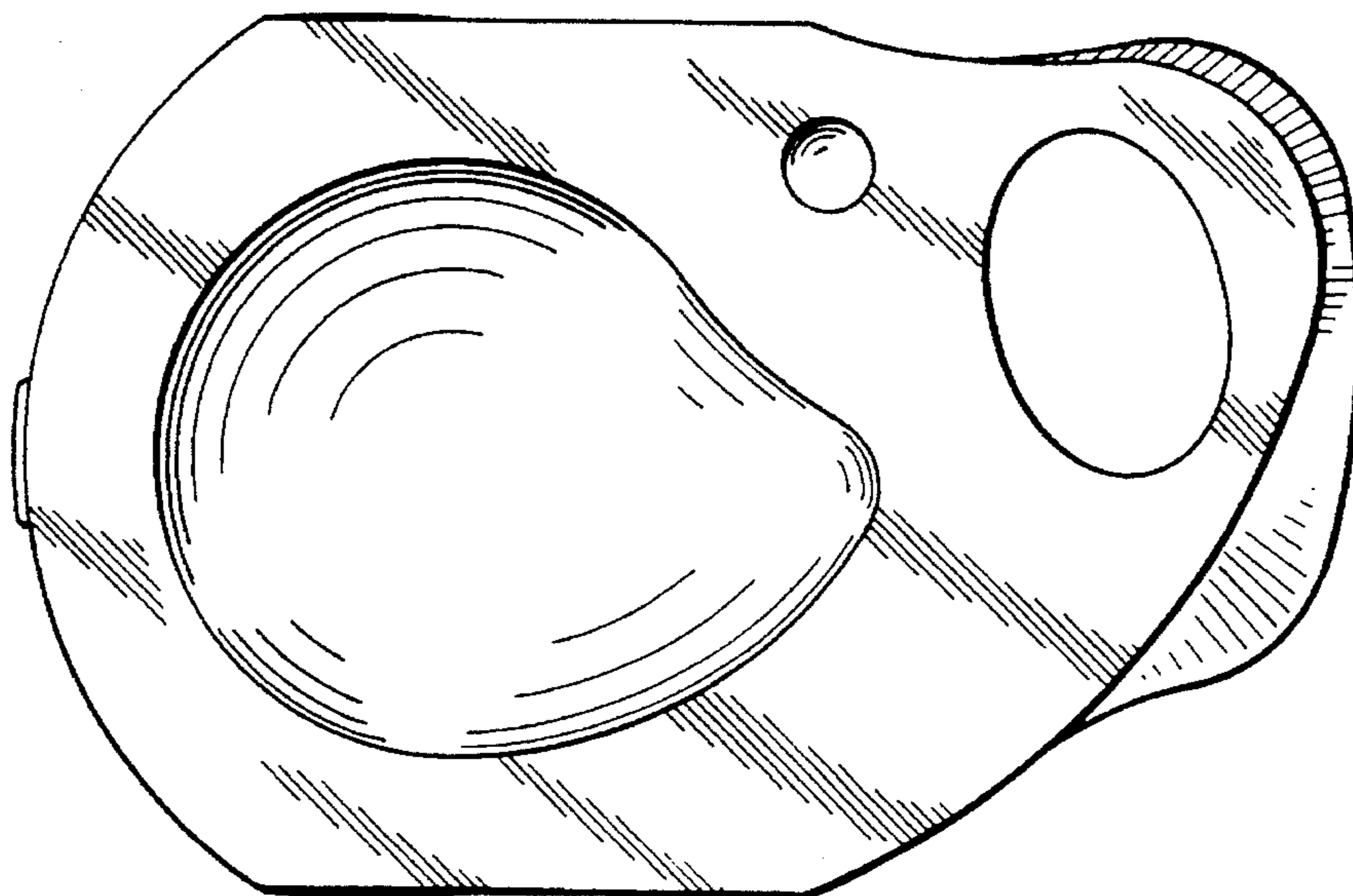

Fig. 4

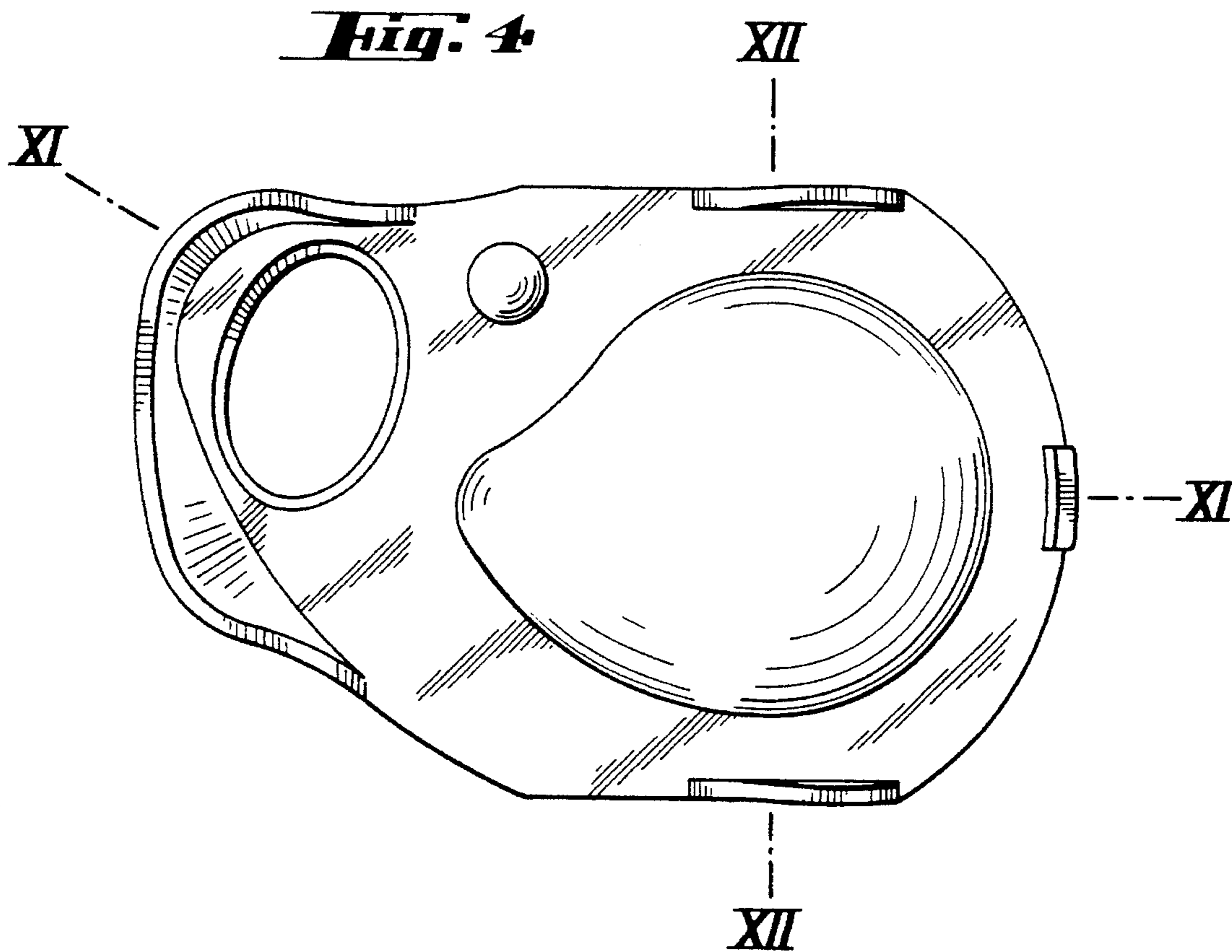

Fig. 5

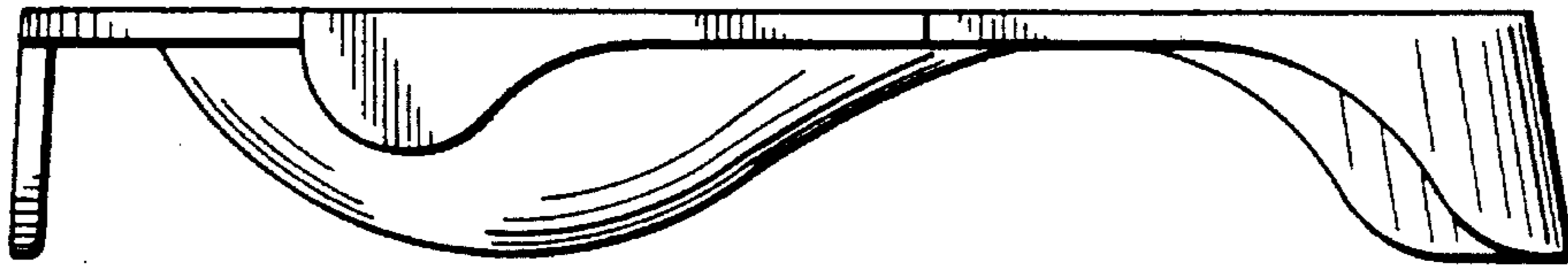

Fig. 6

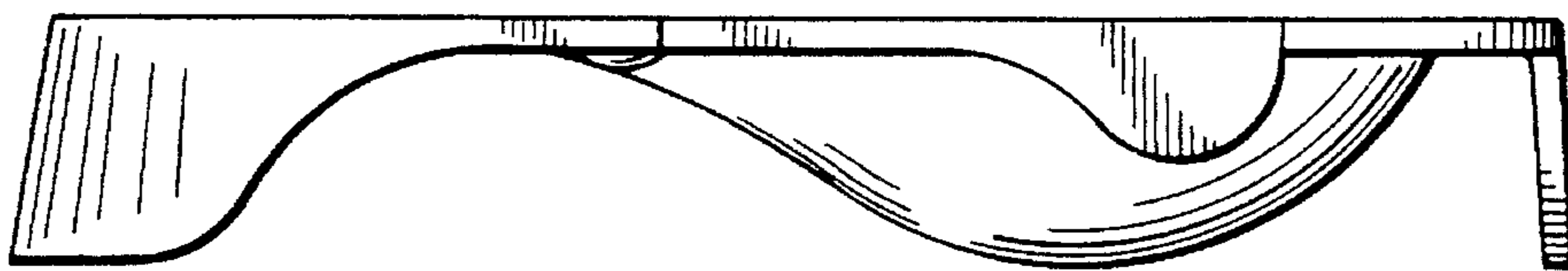

Fig. 7

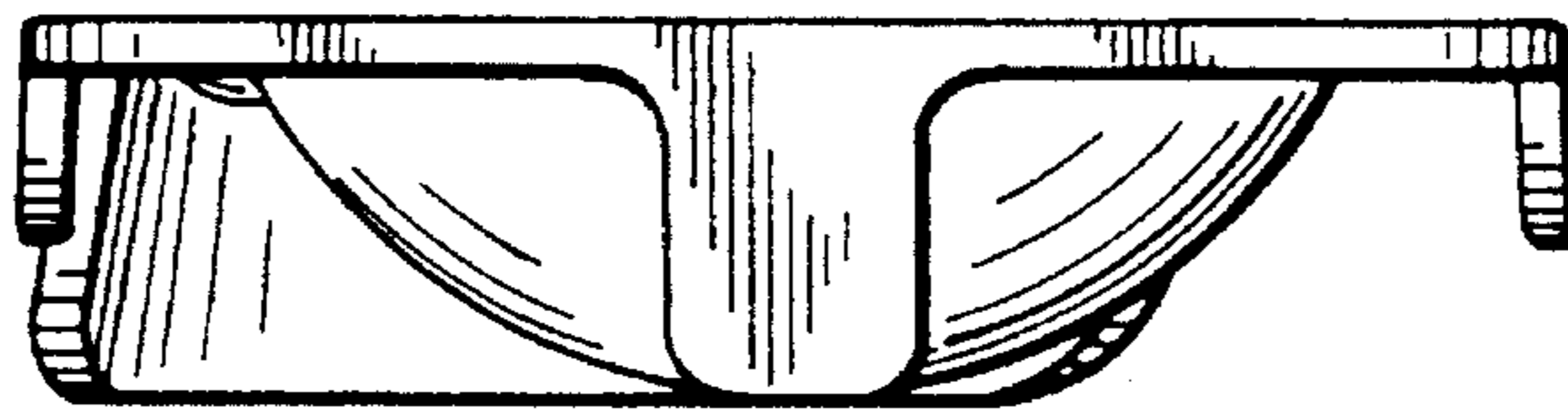
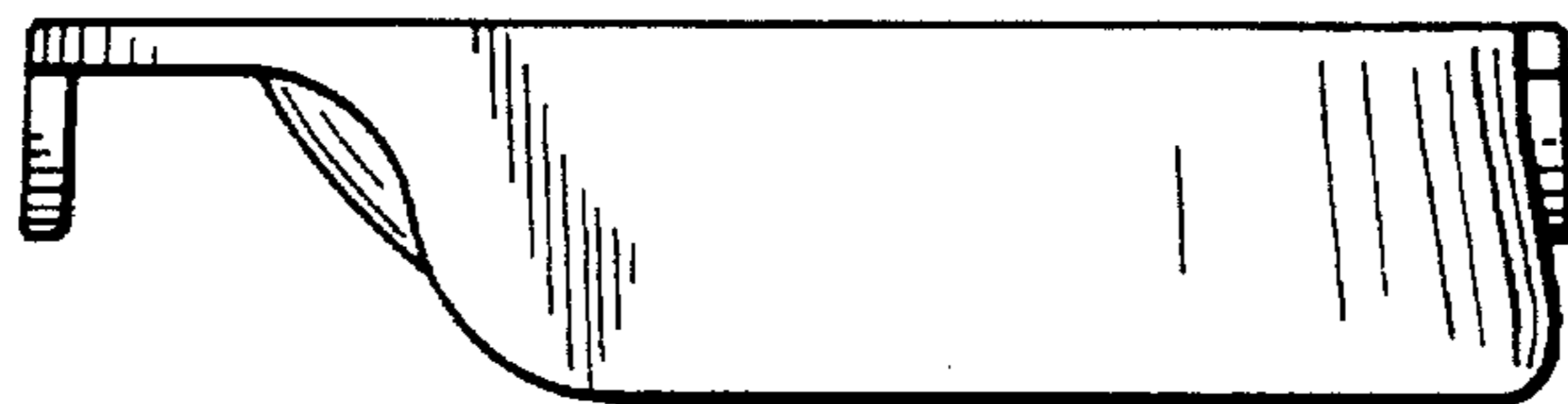

Fig. 8



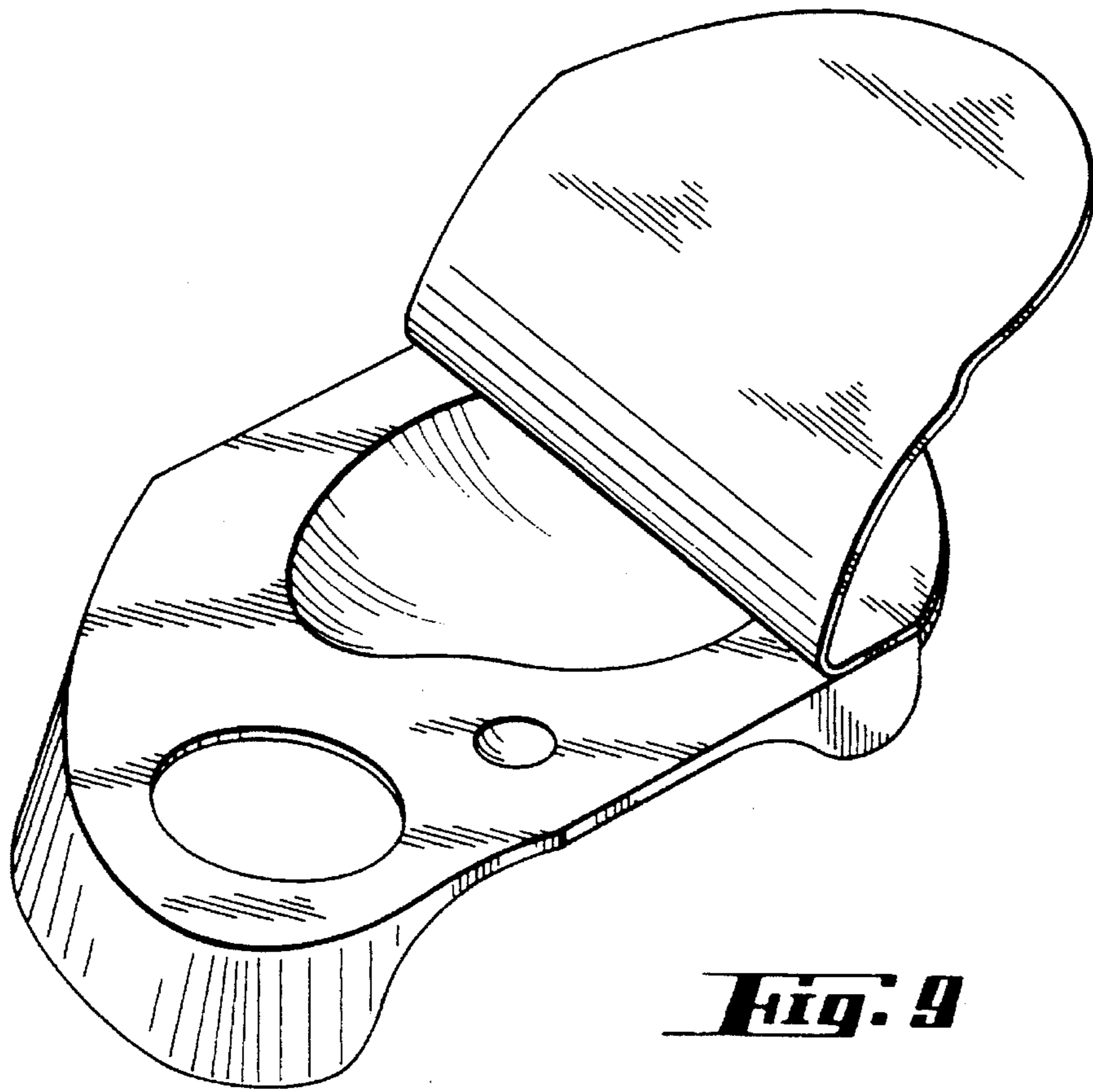

Fig. 9

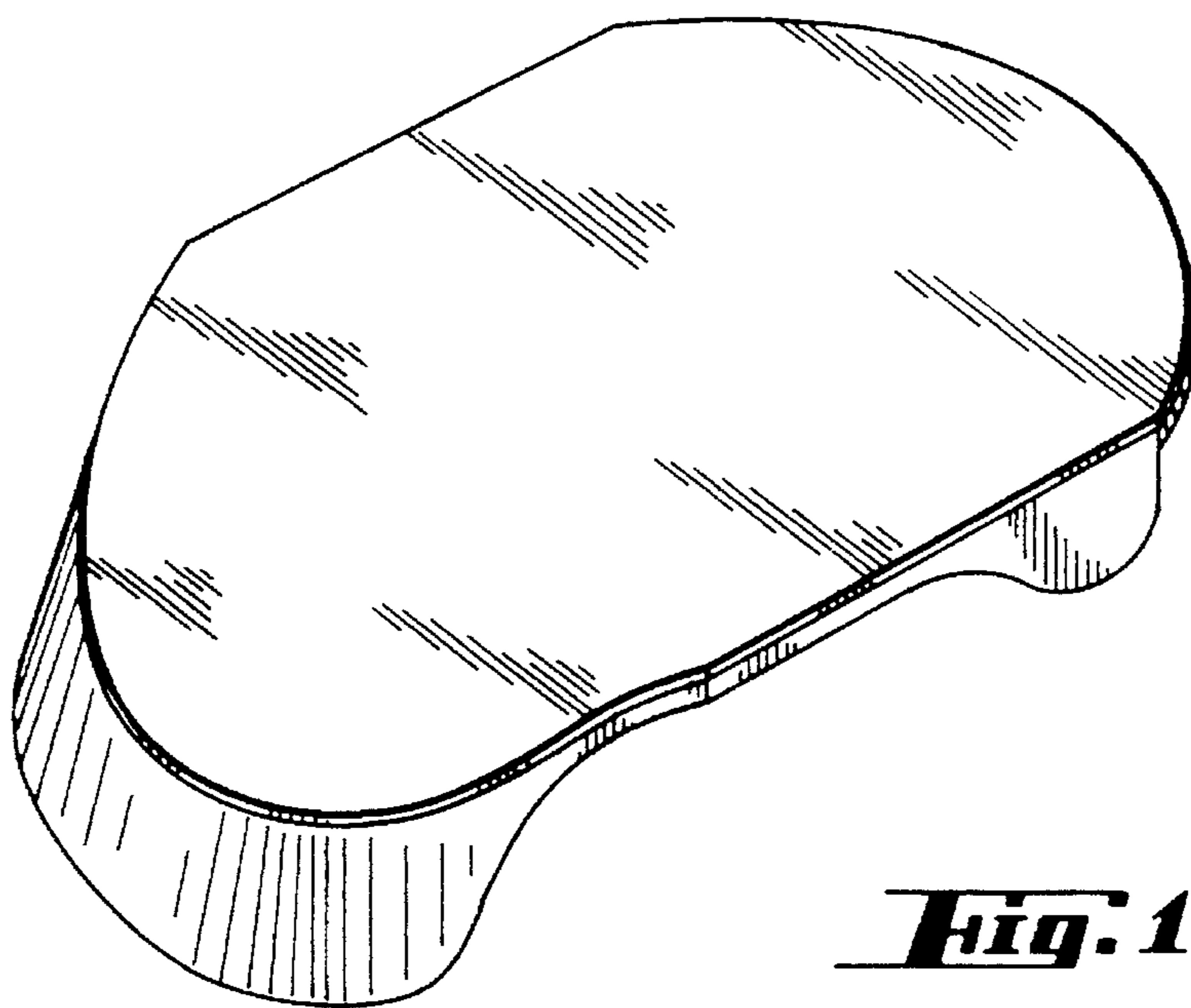

Fig. 10

Fig. 11

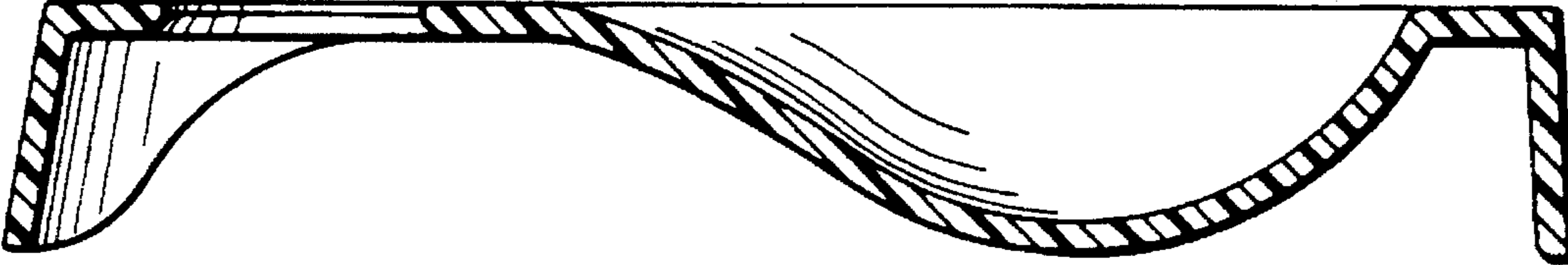

Fig. 12

