



US00D371597S

# United States Patent [19]

[11] Patent Number: **Des. 371,597**

**Dannenberg et al.**

[45] Date of Patent: **\*\*Jul. 9, 1996**

[54] **TUB FOR BATHING**

[75] Inventors: **Todd D. Dannenberg**, Sheboygan;  
**Carter J. Thomas**, Port Washington,  
both of Wis.

[73] Assignee: **Kohler Co.**, Kohler, Wis.

[\*\*] Term: **14 Years**

[21] Appl. No.: **33,974**

[22] Filed: **Jan. 25, 1995**

[52] U.S. Cl. .... **D23/280.3**

[58] Field of Search ..... D23/277, 280.1-280.4;  
D24/201, 202, 204, 205; 4/538, 541.1-541.6

[56] **References Cited**

**U.S. PATENT DOCUMENTS**

D. 276,456	11/1984	Primolt	.....	D23/280.2
D. 295,781	5/1988	Diamond	.....	D23/280.1
D. 313,273	12/1990	Diamond	.....	D23/280.1
D. 335,527	5/1993	Levien	.....	D23/277
D. 338,259	8/1993	Higginbotham	.....	D23/277

**OTHER PUBLICATIONS**

2 pages of MAAX ads showing the Express tub and apron, undated, admitted prior art.  
Eljer ad showing Samoa tub and apron, undated, admitted prior art.  
A Kohler ad showing the Revival handle, undated admitted prior art.

An Oasis ad for the Waterjet tub and apron, undated, admitted prior art.

*Primary Examiner*—Stella Reid  
*Assistant Examiner*—E. Watterson  
*Attorney, Agent, or Firm*—Quarles & Brady

[57] **CLAIM**

The ornamental design for a tub for bathing, as shown and described.

**DESCRIPTION**

FIG. 1 is a perspective view taken from the top, front and right side of a tub for bathing showing our new design; FIG. 2 is a top plan view thereof; FIG. 3 is a front elevational view thereof; FIG. 4 is a right side elevational view thereof; FIG. 5 is a left side elevational view thereof; FIG. 6 is a bottom plan view thereof; FIG. 7 is a cross-sectional view taken on line 7—7 of FIG. 2; FIG. 8 is a cross-sectional view taken on line 8—8 of FIG. 2; and, FIG. 9 is a top plan view of a second embodiment, which is a mirror image of the first, the front elevational view being the mirror image of FIG. 3, the left side elevational view being the mirror image of FIG. 4, and the right side elevational view being the mirror image of FIG. 5; The fragmentary broken line representations of walls in FIG. 1 are for the purpose of illustration only and form no part of the claimed design.

**1 Claim, 6 Drawing Sheets**

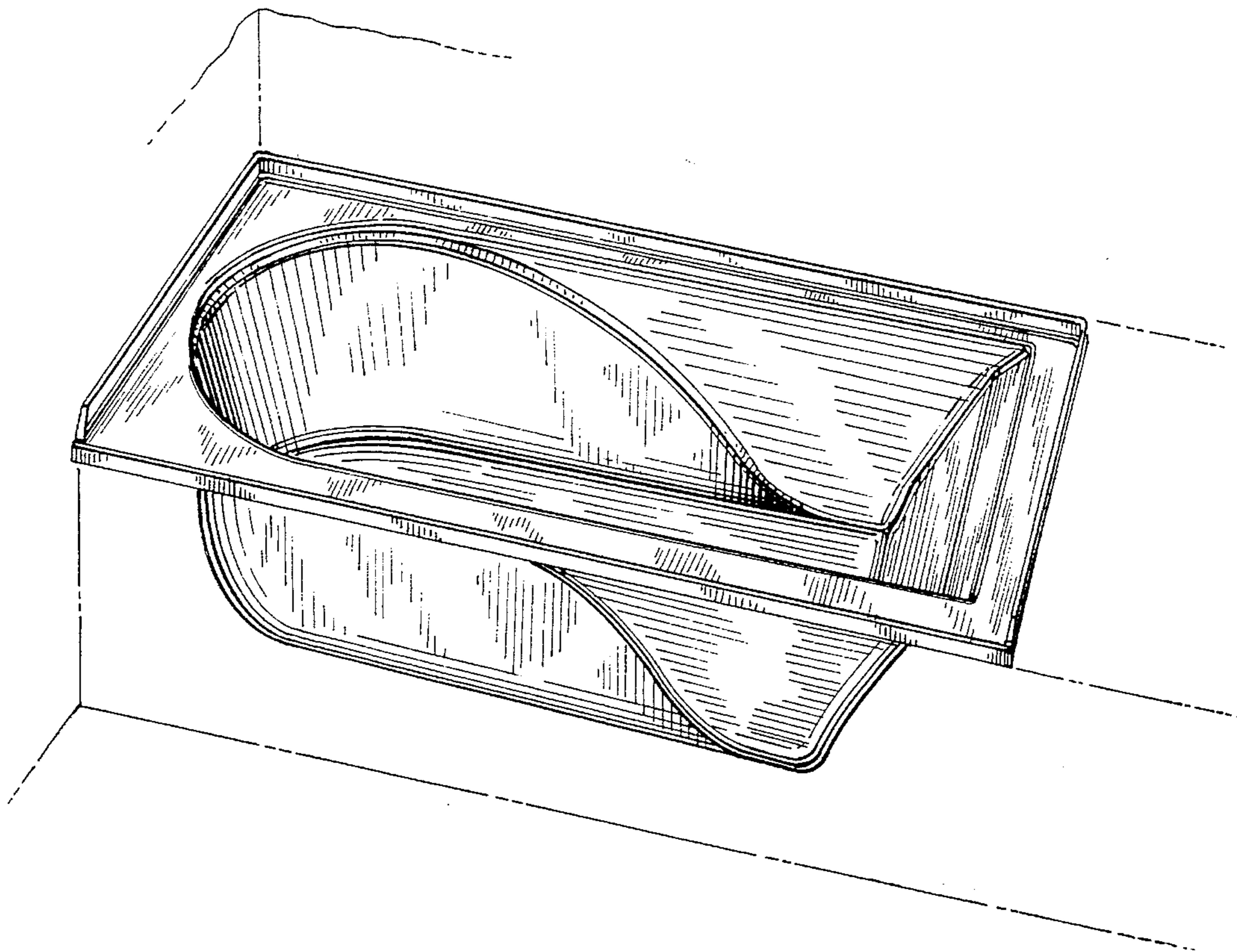

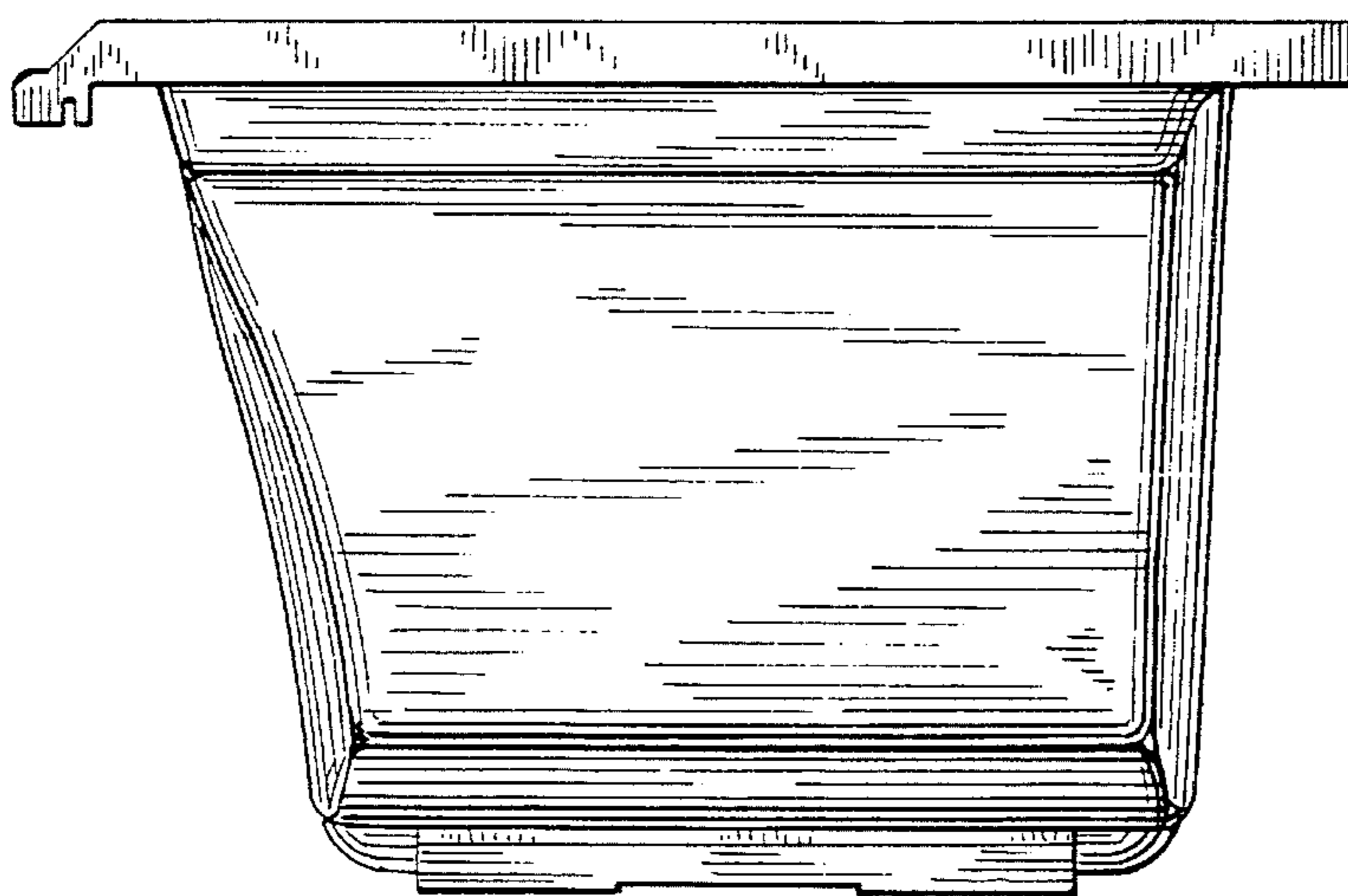
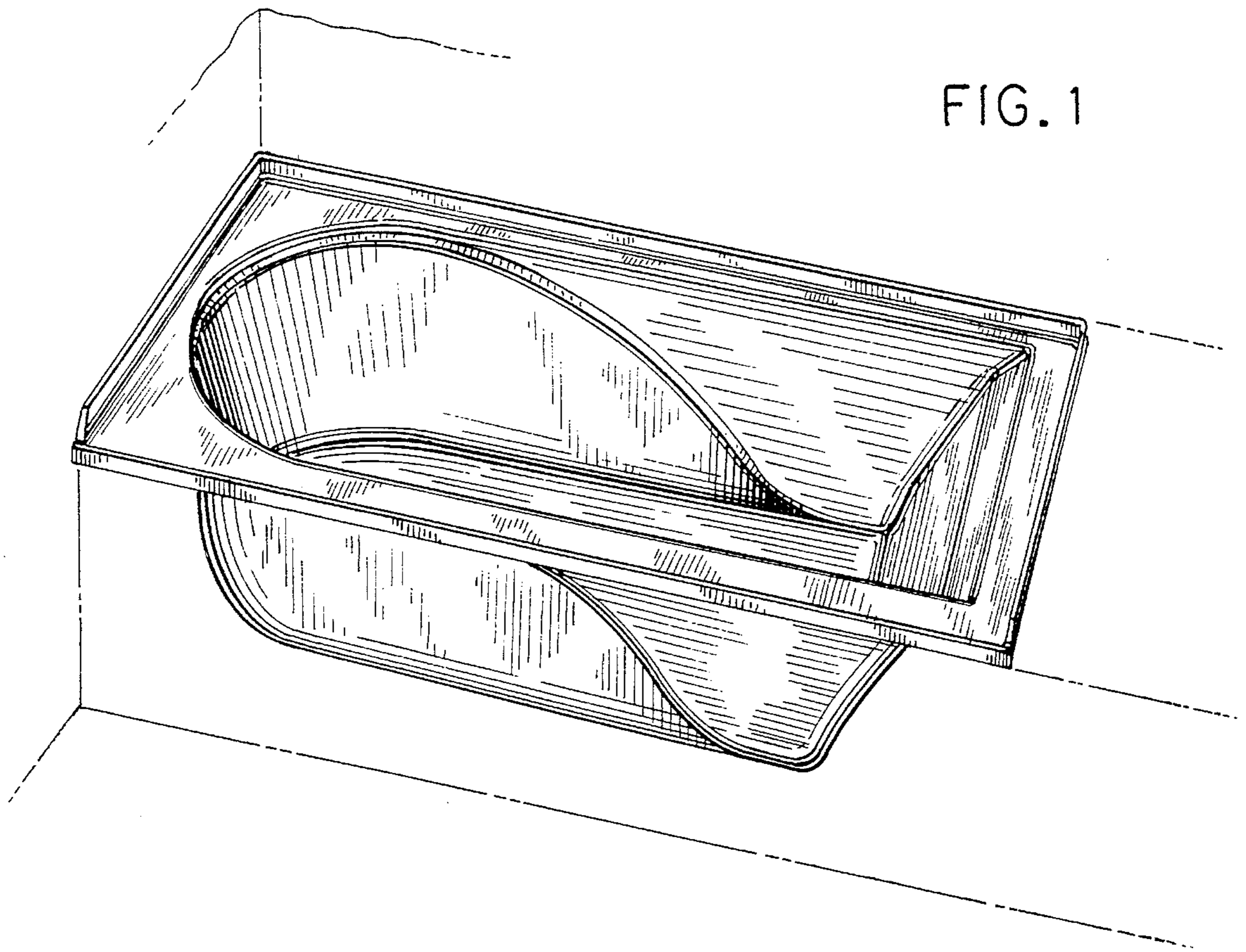



FIG. 2

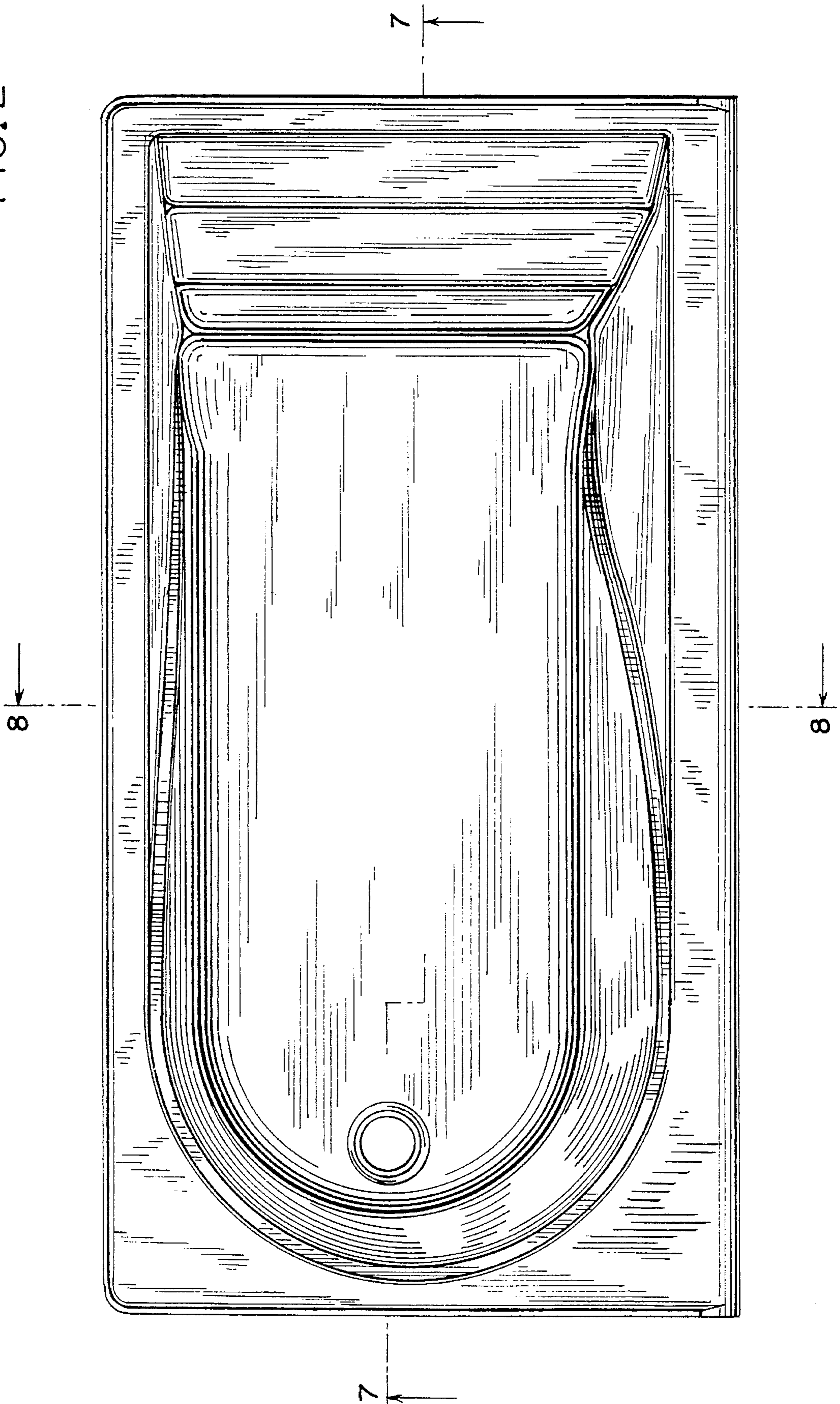

FIG. 3

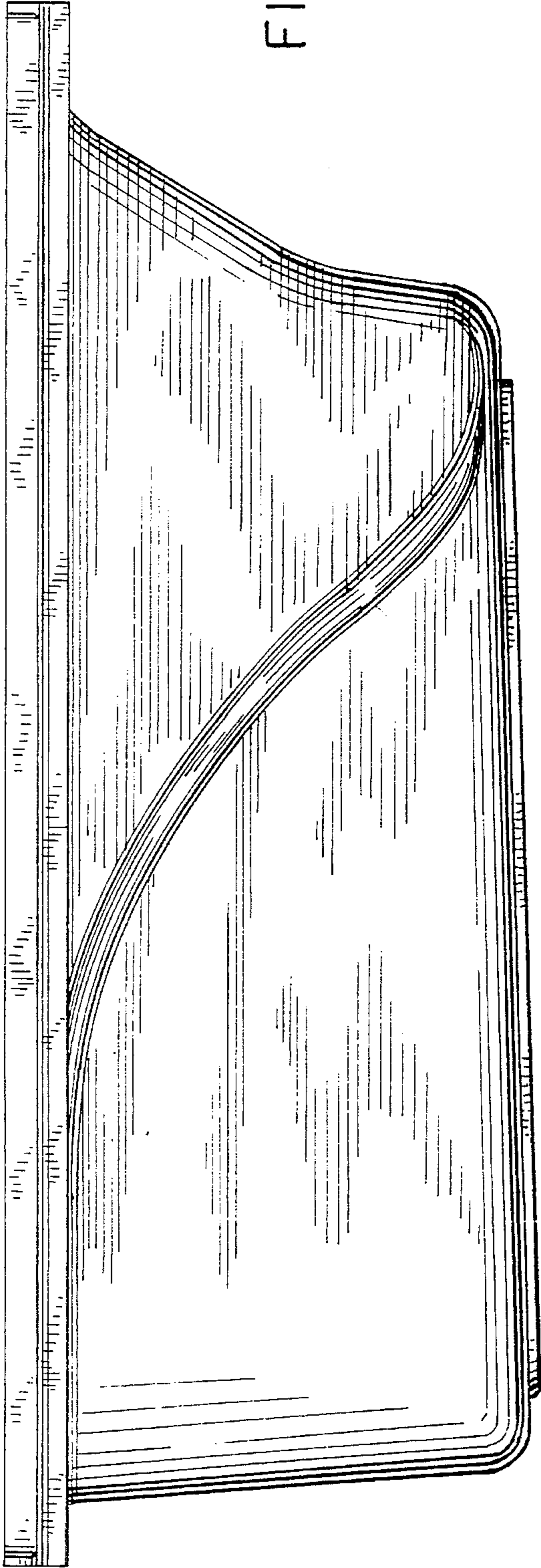
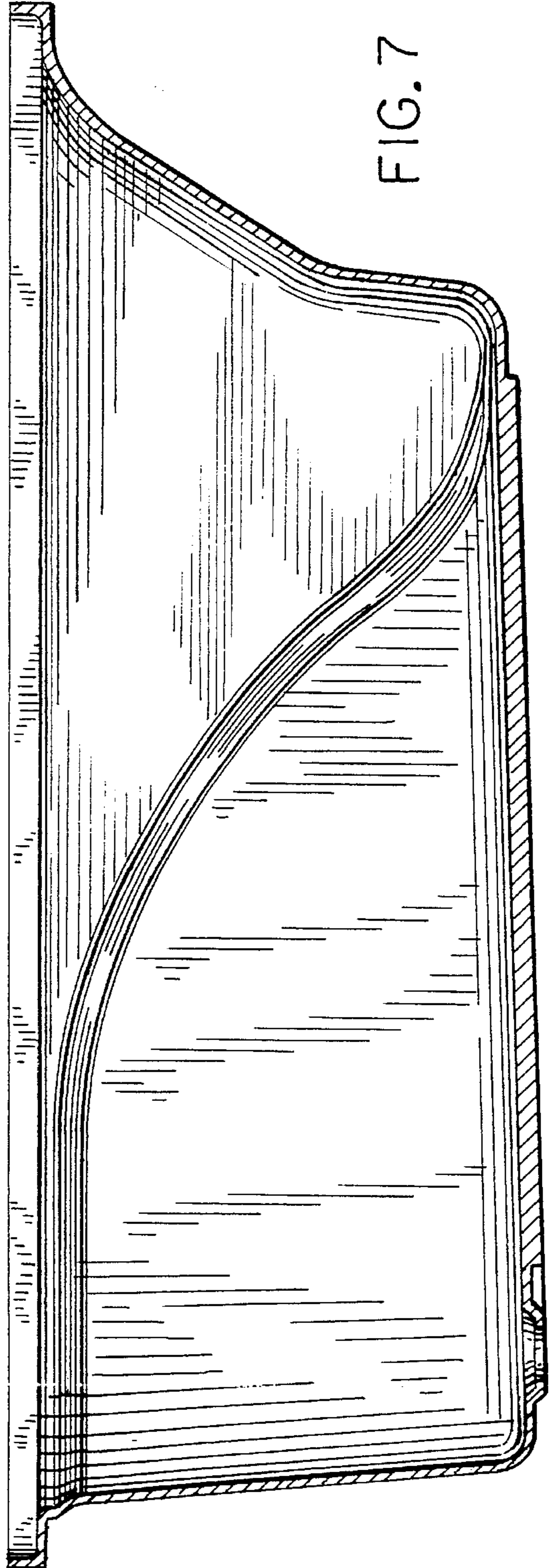

FIG. 7



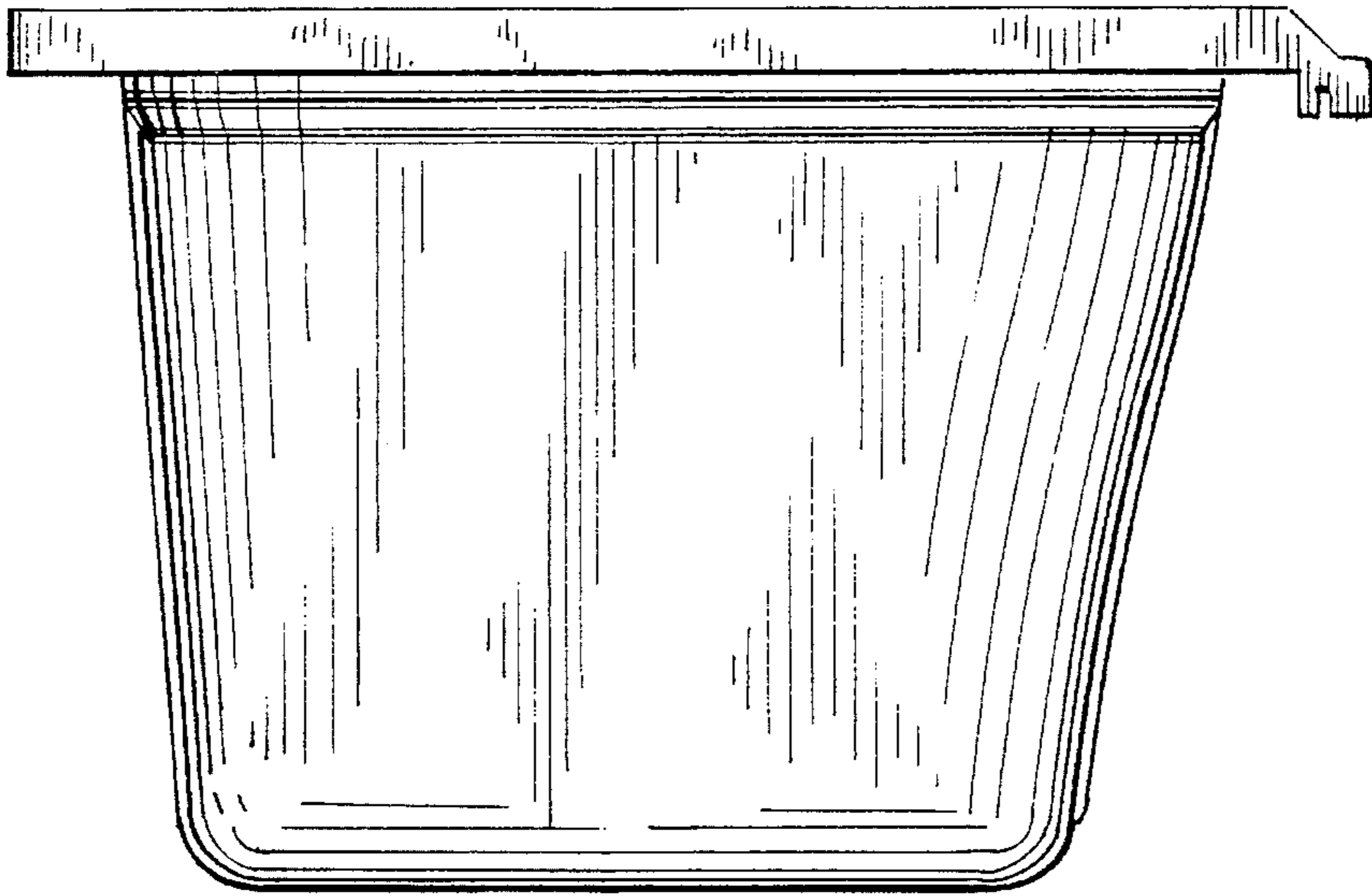

FIG. 5

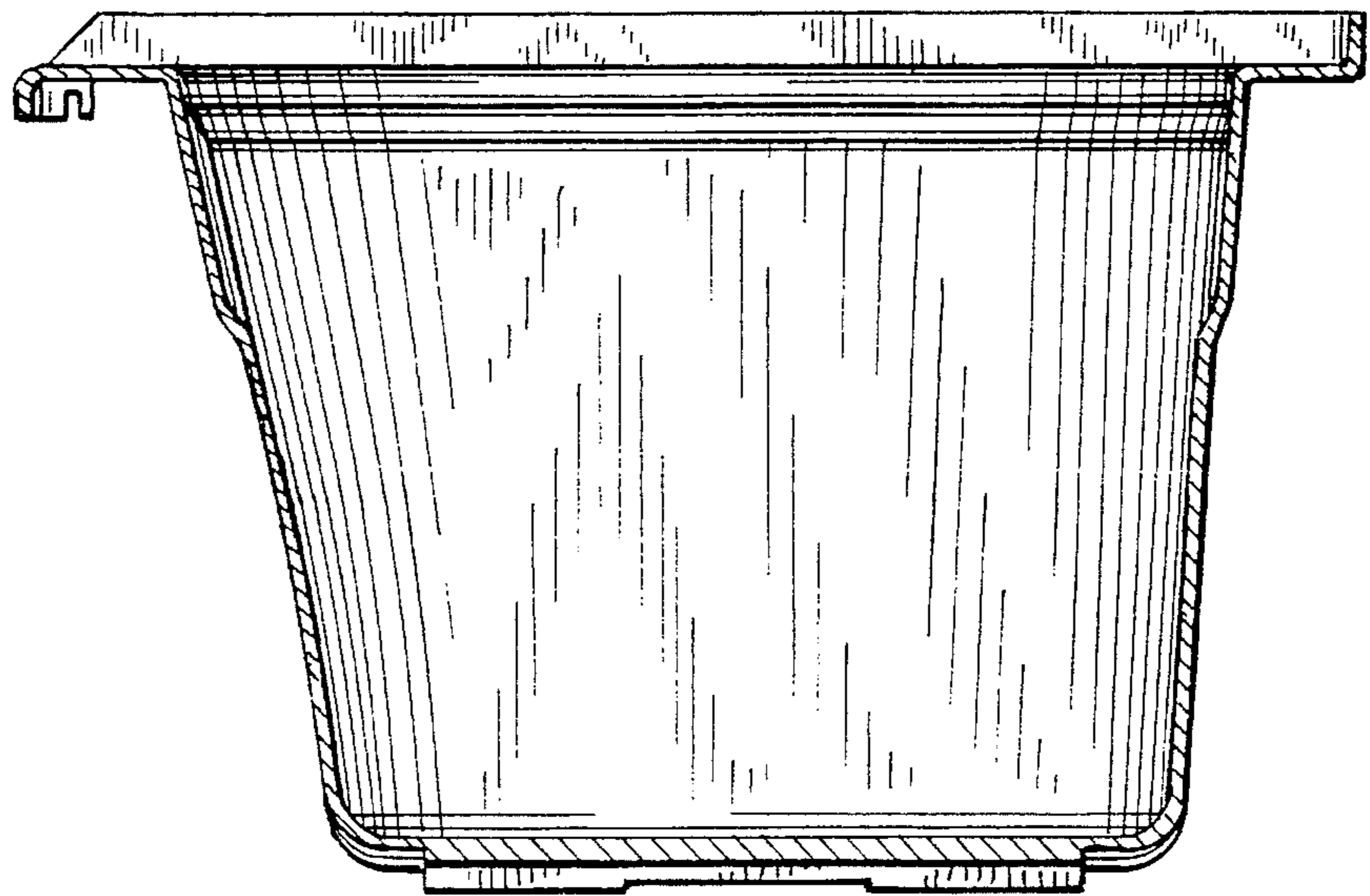

FIG. 8



FIG. 6

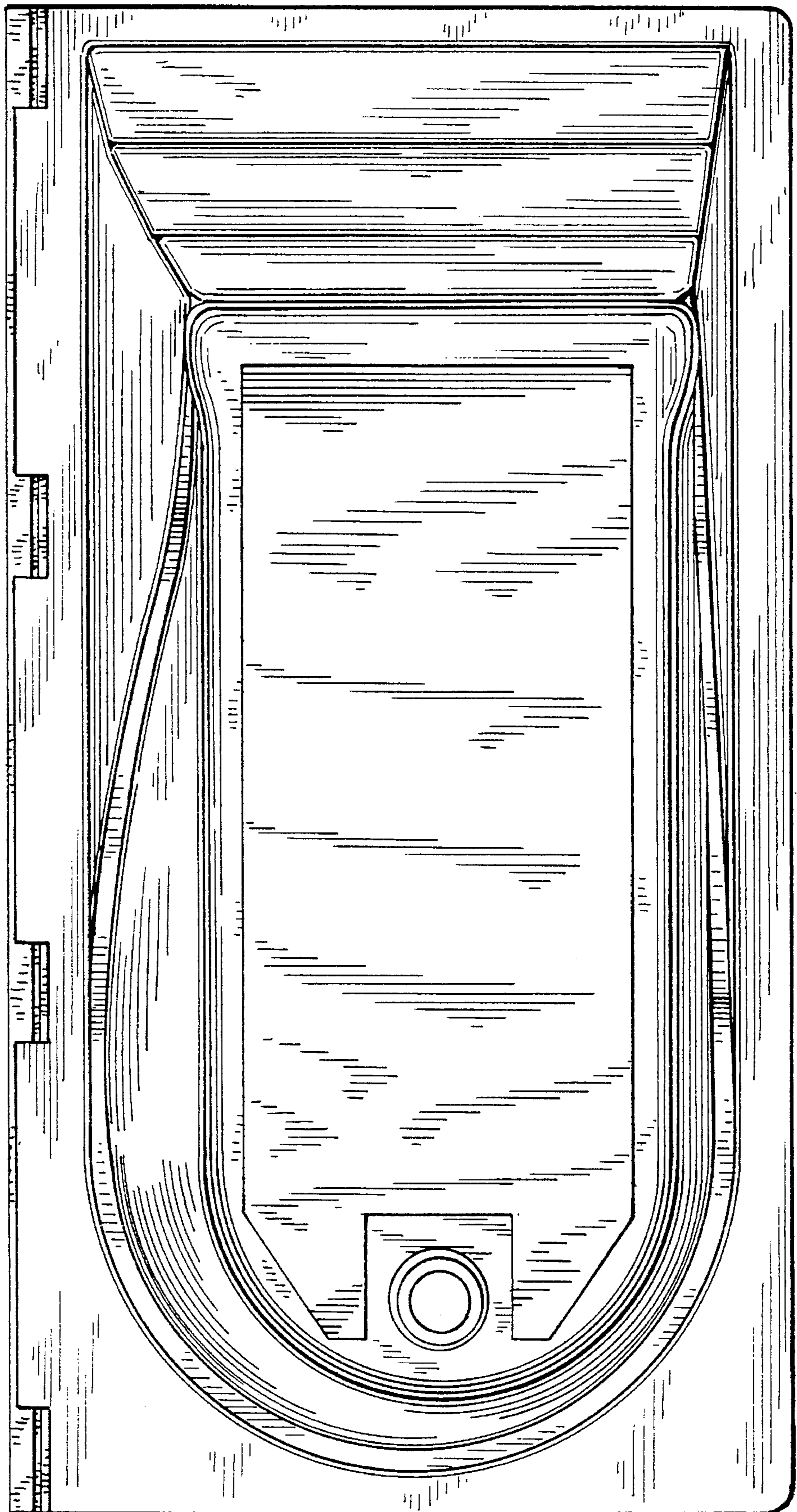

FIG. 9

