



US00D371479S

United States Patent [19]

Hirst

[11] Patent Number: **Des. 371,479**

[45] Date of Patent: ****Jul. 9, 1996**

[54] **SHOWER DISPENSER**

[75] Inventor: **Kenneth W. Hirst**, New York, N.Y.

[73] Assignee: **The Gillette Company**, Boston, Mass.

[**] Term: **14 Years**

[21] Appl. No.: **38,997**

[22] Filed: **May 18, 1995**

[52] U.S. Cl. **D6/542**

[58] Field of Search D6/542-545; D9/300;
222/402.11, 173, 180, 181.1, 181.2, 257

[56] **References Cited**

U.S. PATENT DOCUMENTS

D. 321,130	10/1991	Goberman	D9/370
D. 340,644	10/1993	Hirst	D9/424
D. 347,385	5/1994	Kunesh	D9/300
D. 352,458	11/1994	Gray	D9/520
D. 363,981	11/1995	Muderlak	D9/300
4,678,102	7/1987	Ryder	222/181

Primary Examiner—Brian N. Vinson
Attorney, Agent, or Firm—Stephan P. Williams

[57] **CLAIM**

The ornamental design for a shower dispenser, as shown and described.

DESCRIPTION

FIG. 1 is a perspective view as seen from the top, front and right side of a shower dispenser showing my new design; FIG. 2 is a front elevational view thereof; FIG. 3 is a rear elevational view thereof; FIG. 4 is a right side elevational view thereof, the left side elevation being a mirror image thereof; FIG. 5 is a top plan view thereof; FIG. 6 is a bottom plan view thereof; and, FIG. 7 is a front elevational view of the shower dispenser shown in FIG. 1 with the hook in the hanging position and the flip-cap in the open position.

1 Claim, 4 Drawing Sheets

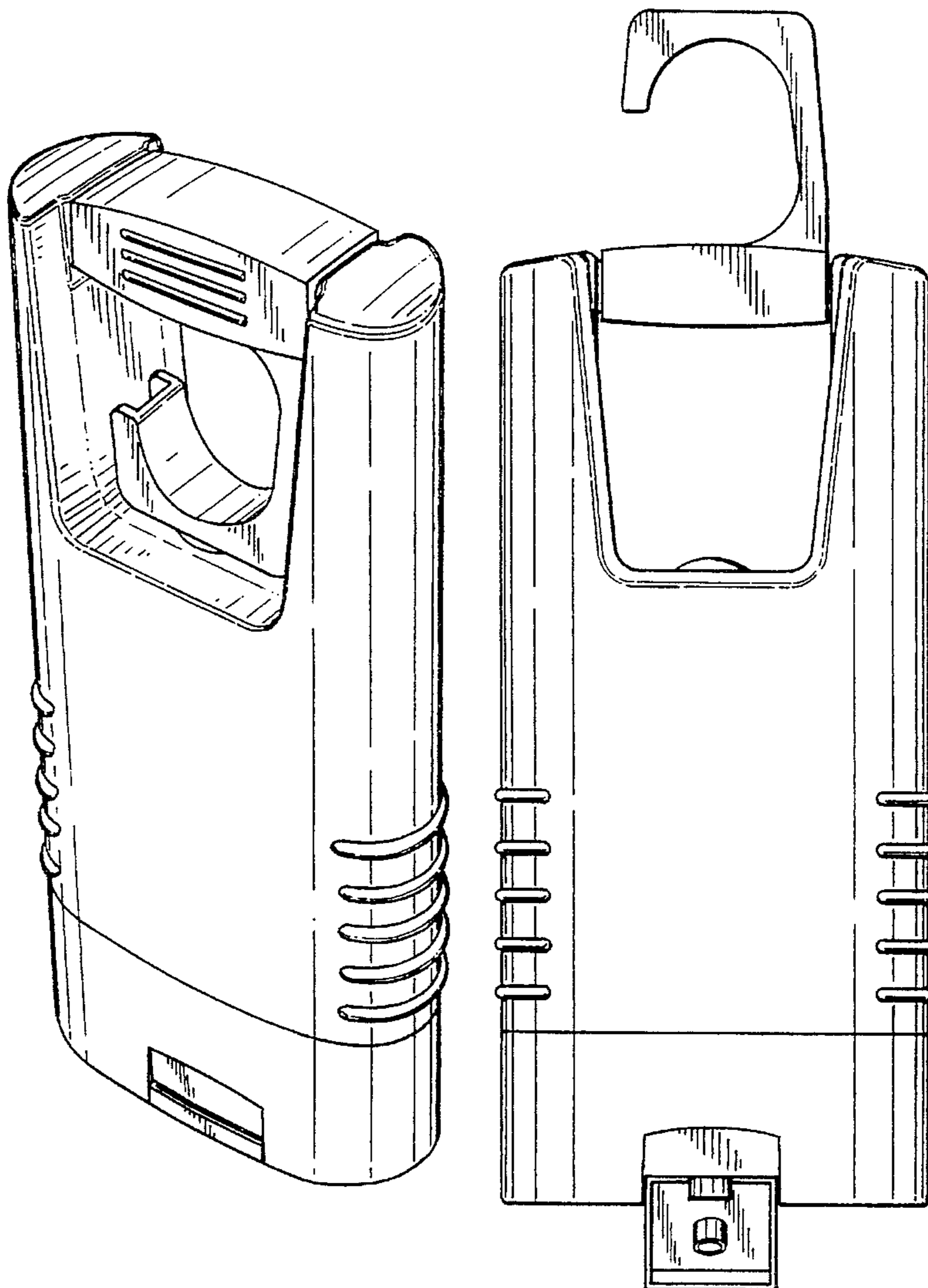

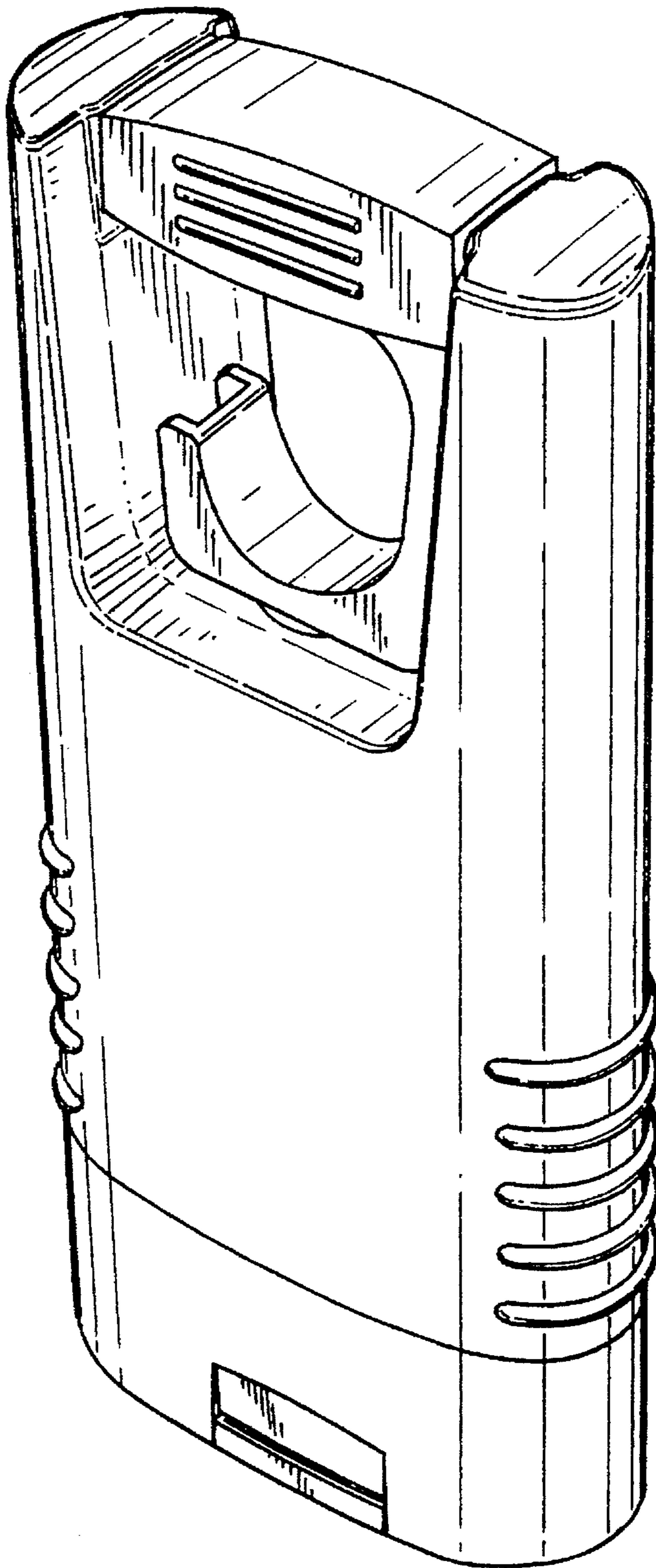

FIG. 1

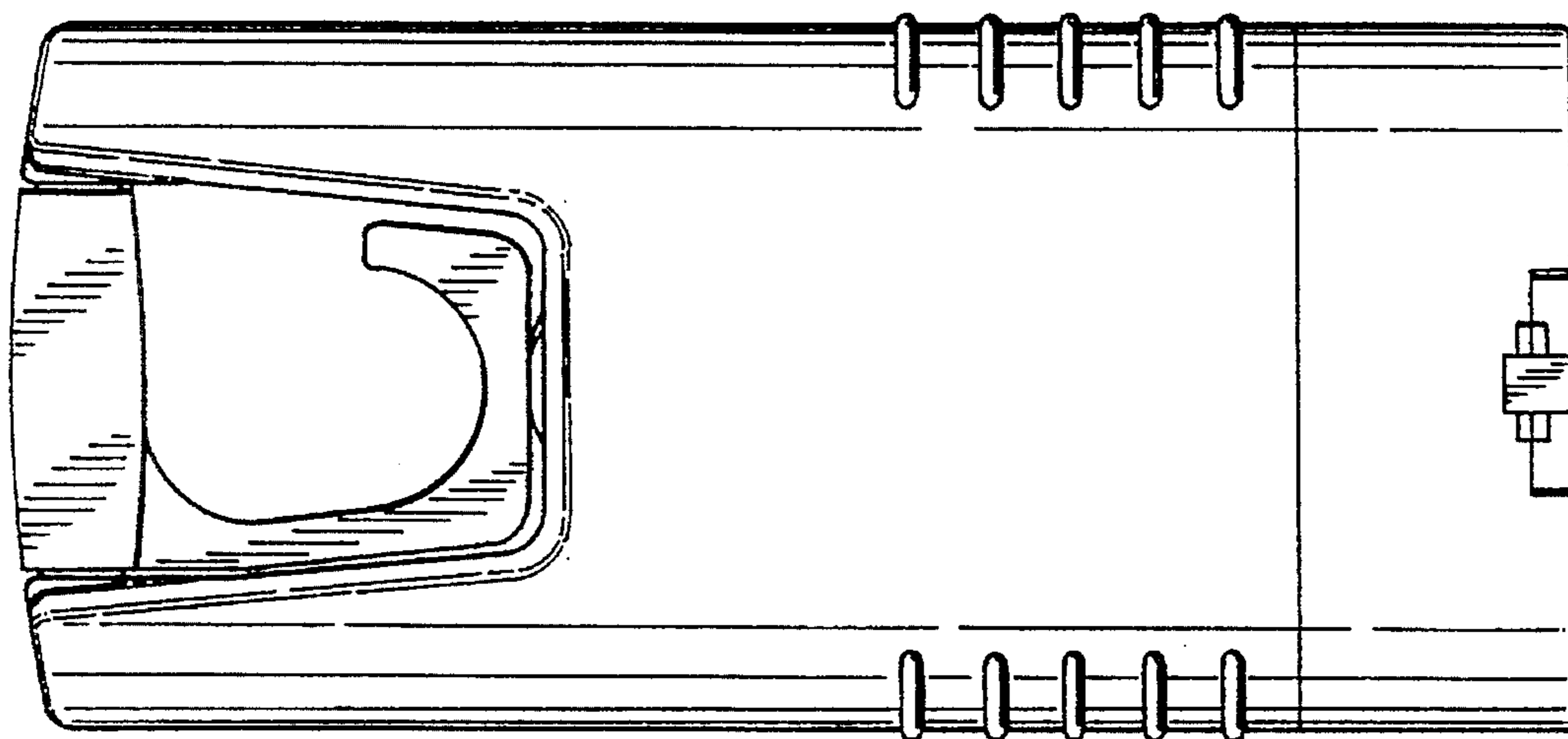

FIG. 3

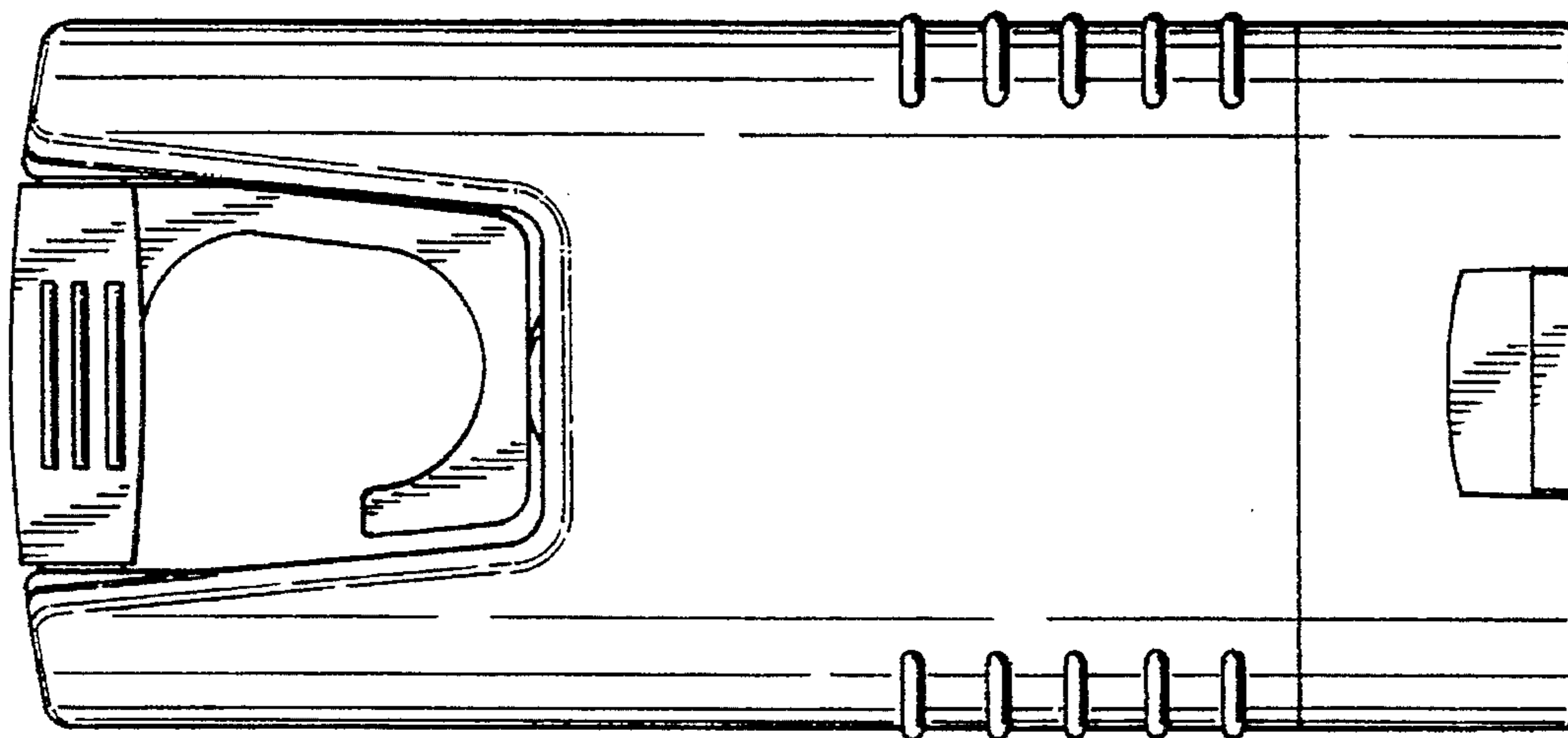

FIG. 2

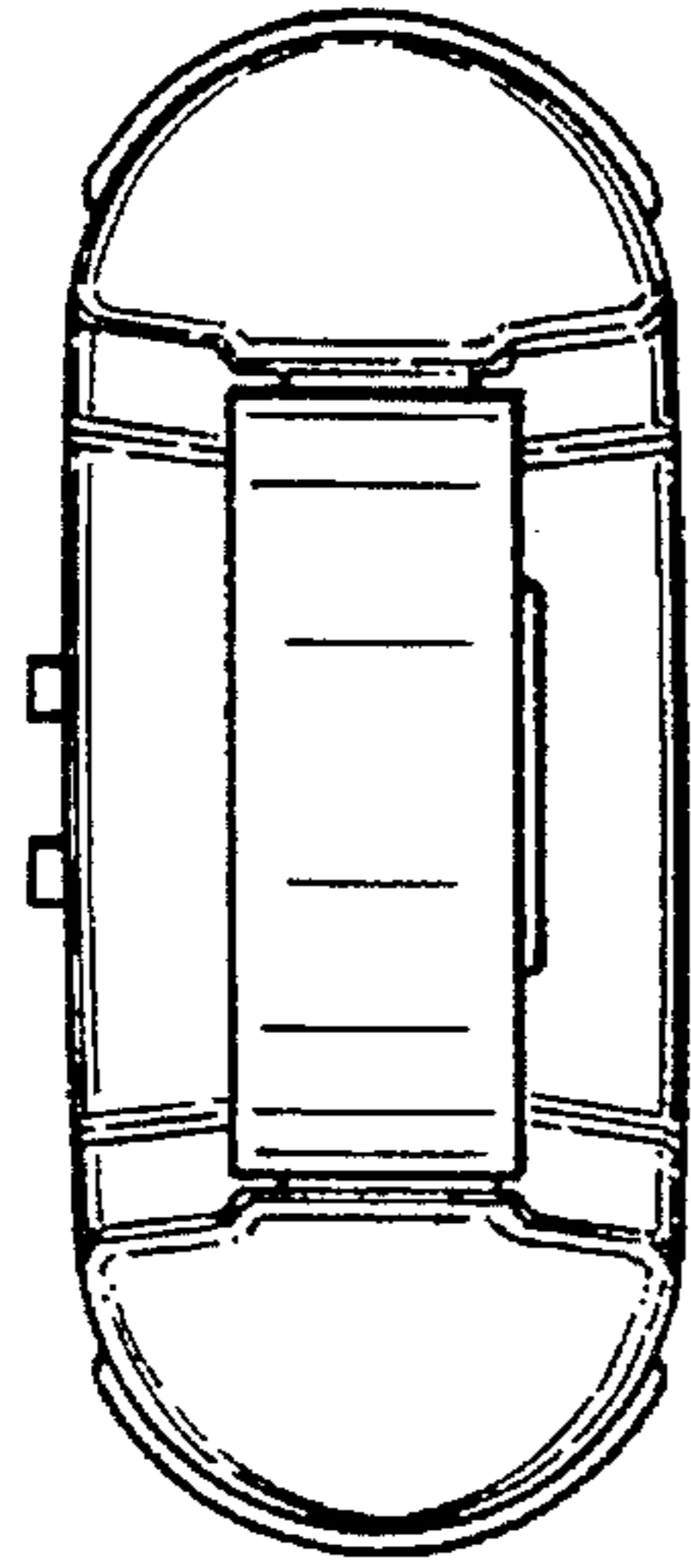

FIG. 5

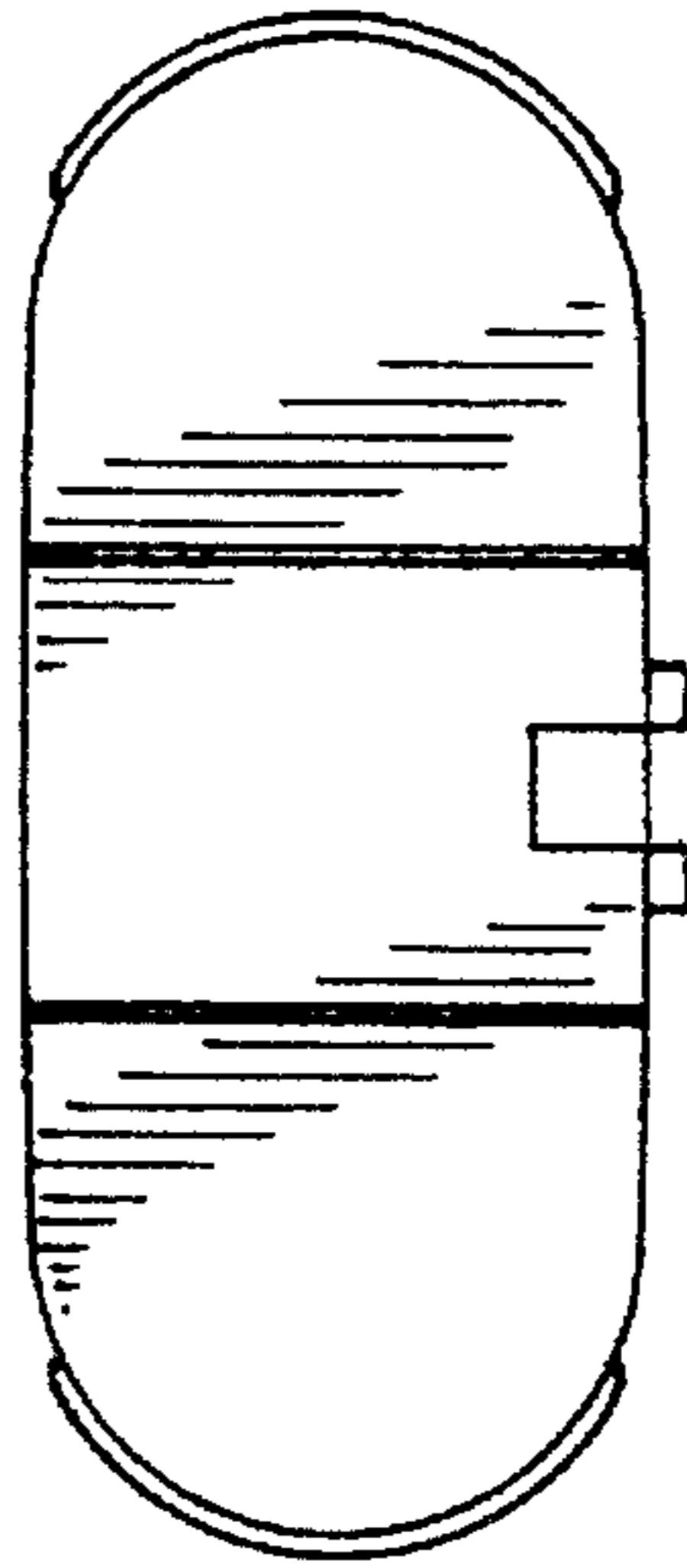

FIG. 6

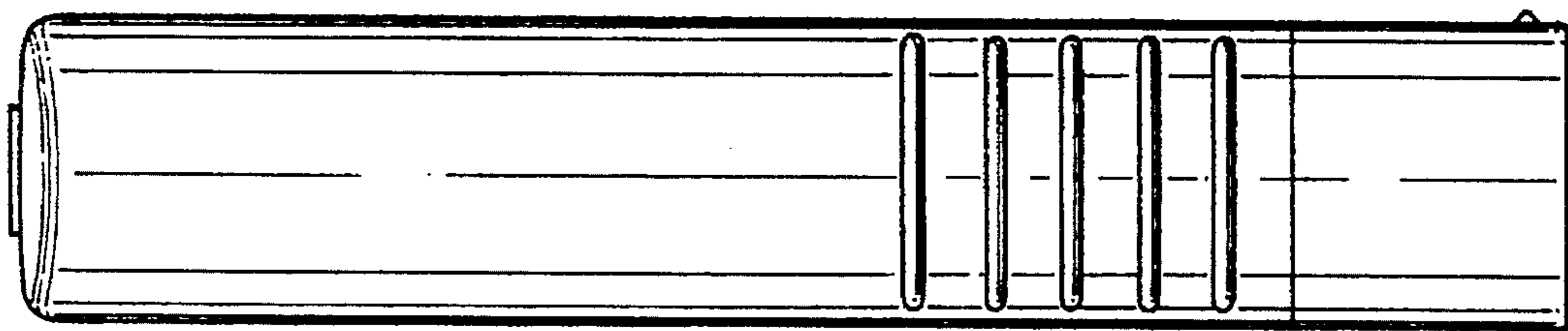

FIG. 4

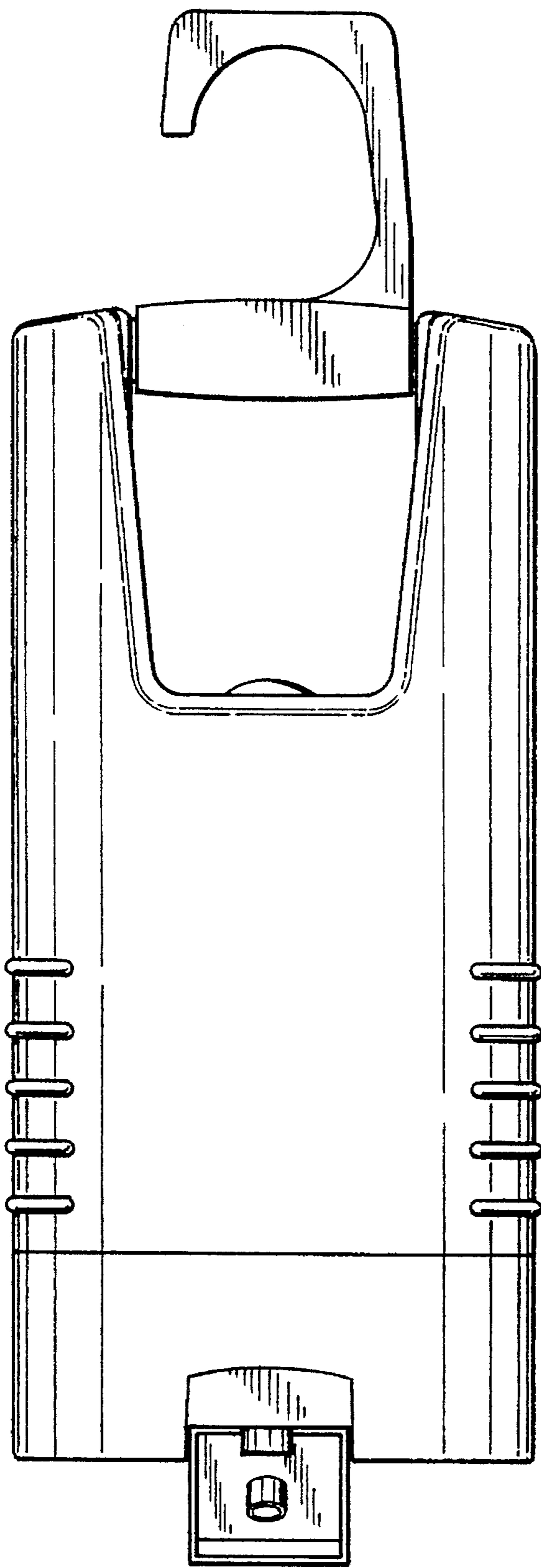

FIG. 7