



US00D371466S

United States Patent [19]

[11] Patent Number: **Des. 371,466**

Boisson

[45] Date of Patent: ****Jul. 9, 1996**

[54] **LAWN CHAIR**

Primary Examiner—Gary D. Watson
Attorney, Agent, or Firm—Levine & Mandelbaum

[76] Inventor: **Judi Boisson**, 134 Mariner Dr.,
Southampton, N.Y. 11968

[57] **CLAIM**

[**] Term: **14 Years**

The ornamental design for a lawn chair, as shown and described.

[21] Appl. No.: **43,123**

DESCRIPTION

[22] Filed: **Aug. 25, 1995**

[52] U.S. Cl. **D6/370**

[58] Field of Search D6/334, 351, 367,
D6/368, 370, 374, 379, 500, 501, 502;
297/31, 39

FIG. 1 is a perspective view of a lawn chair showing my new design;

FIG. 2 is a front elevation view of a lawn chair showing my new design;

FIG. 3 is a top plan view of a lawn chair showing my new design;

FIG. 4 is a right side elevation view of a lawn chair showing my new design, the left side being a mirror image thereof;

FIG. 5 is a rear elevation view of a lawn chair showing my new design; and,

FIG. 6 is a bottom plan view of a lawn chair showing my new design.

[56] **References Cited**

U.S. PATENT DOCUMENTS

D. 103,575	3/1937	Janes	D6/370
D. 109,239	4/1938	Wolpin	D6/370
D. 295,927	5/1988	Hickey	D6/370
D. 319,354	8/1991	Wolcott	D6/370
4,707,023	11/1987	Hickey	D6/370 X

1 Claim, 3 Drawing Sheets

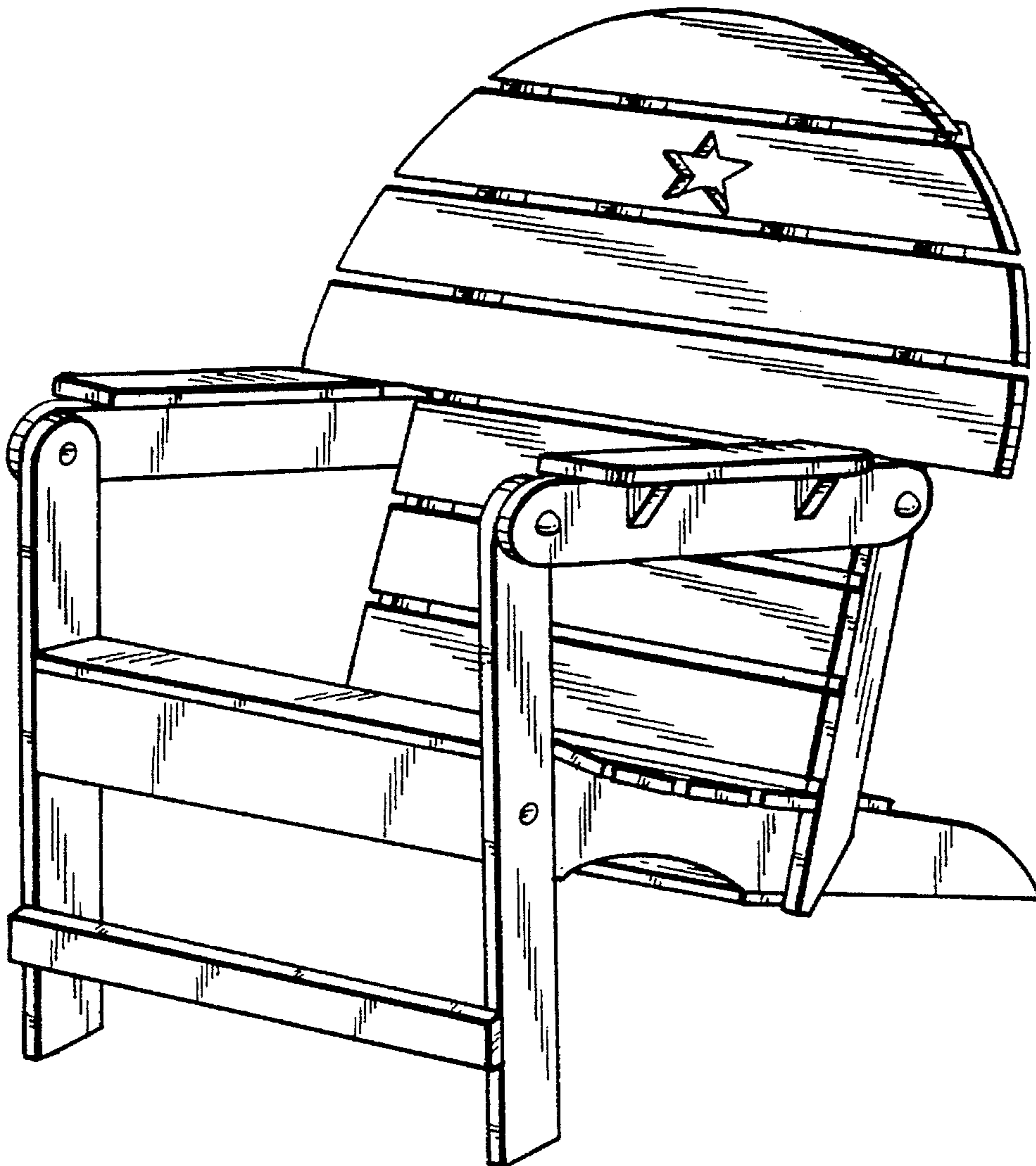

FIG. 1

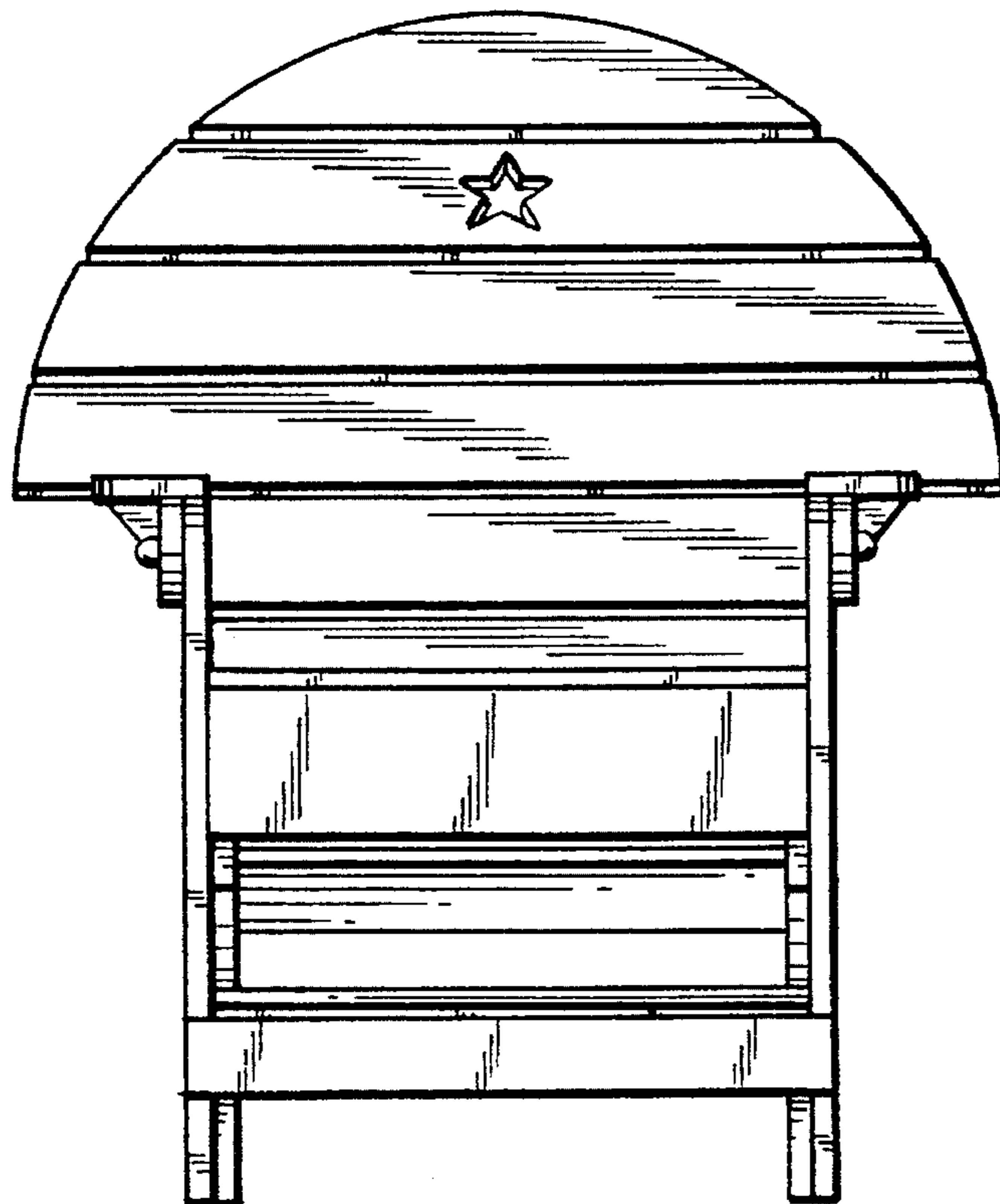
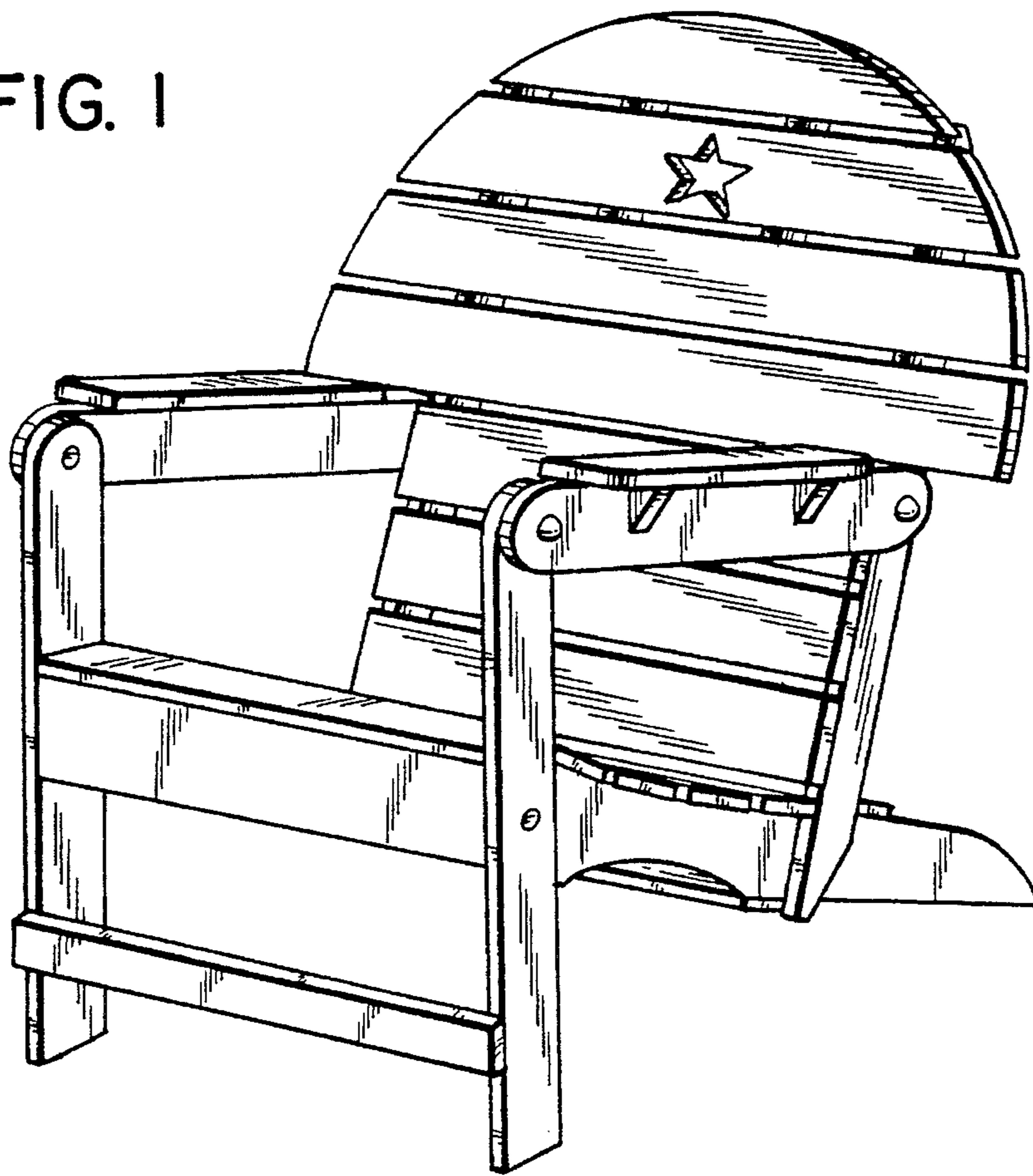

FIG. 2

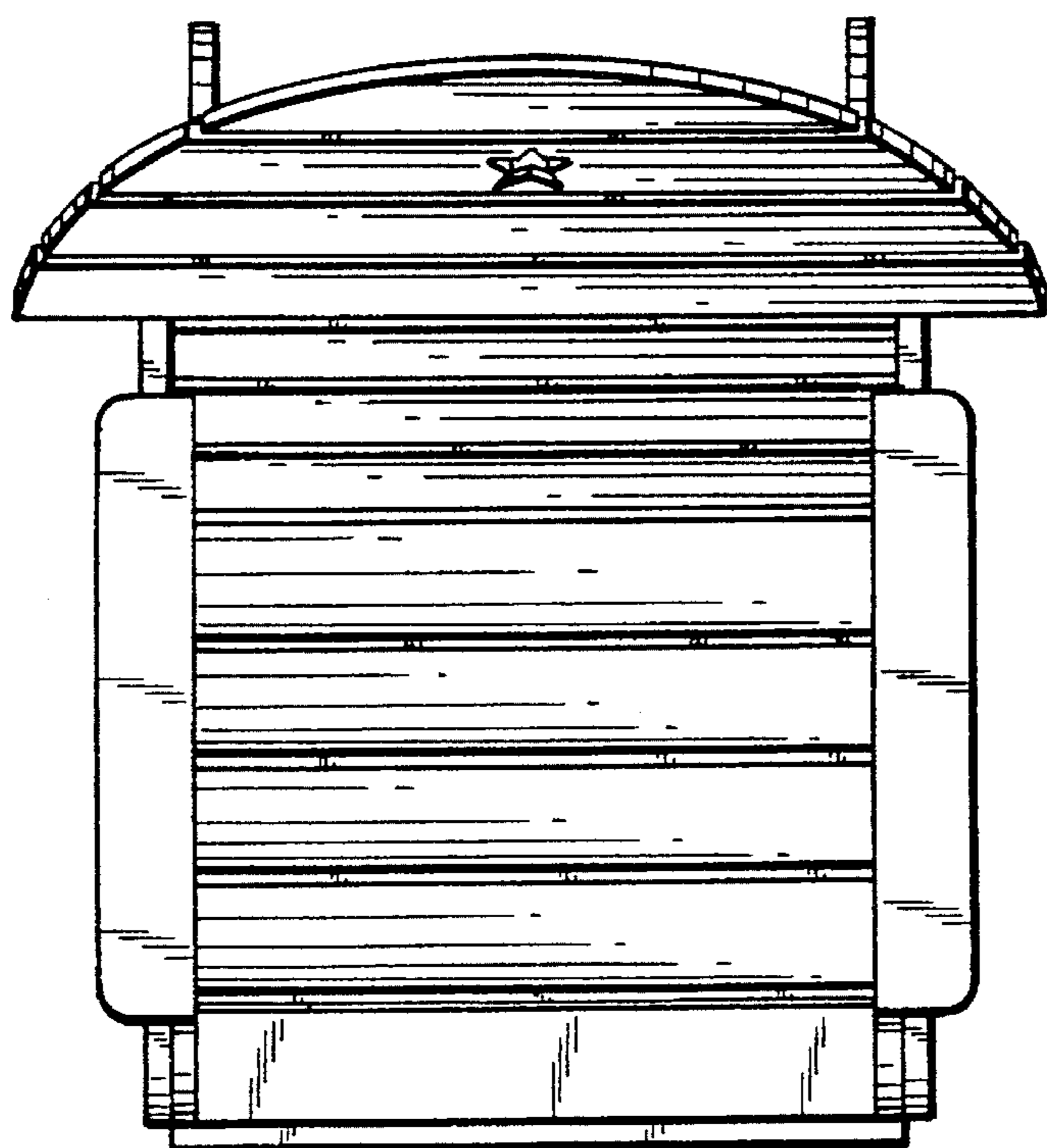
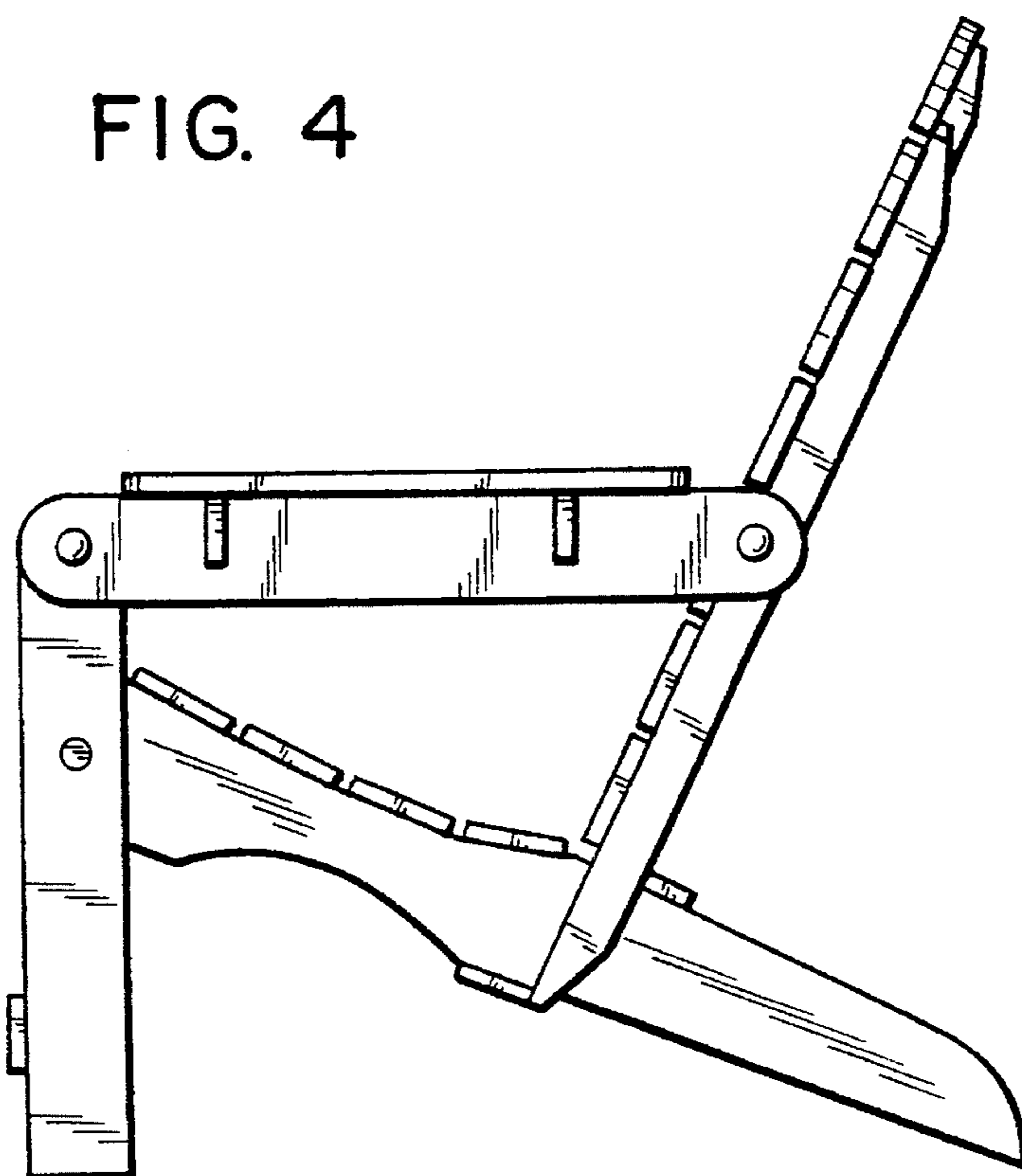

FIG. 3

FIG. 4



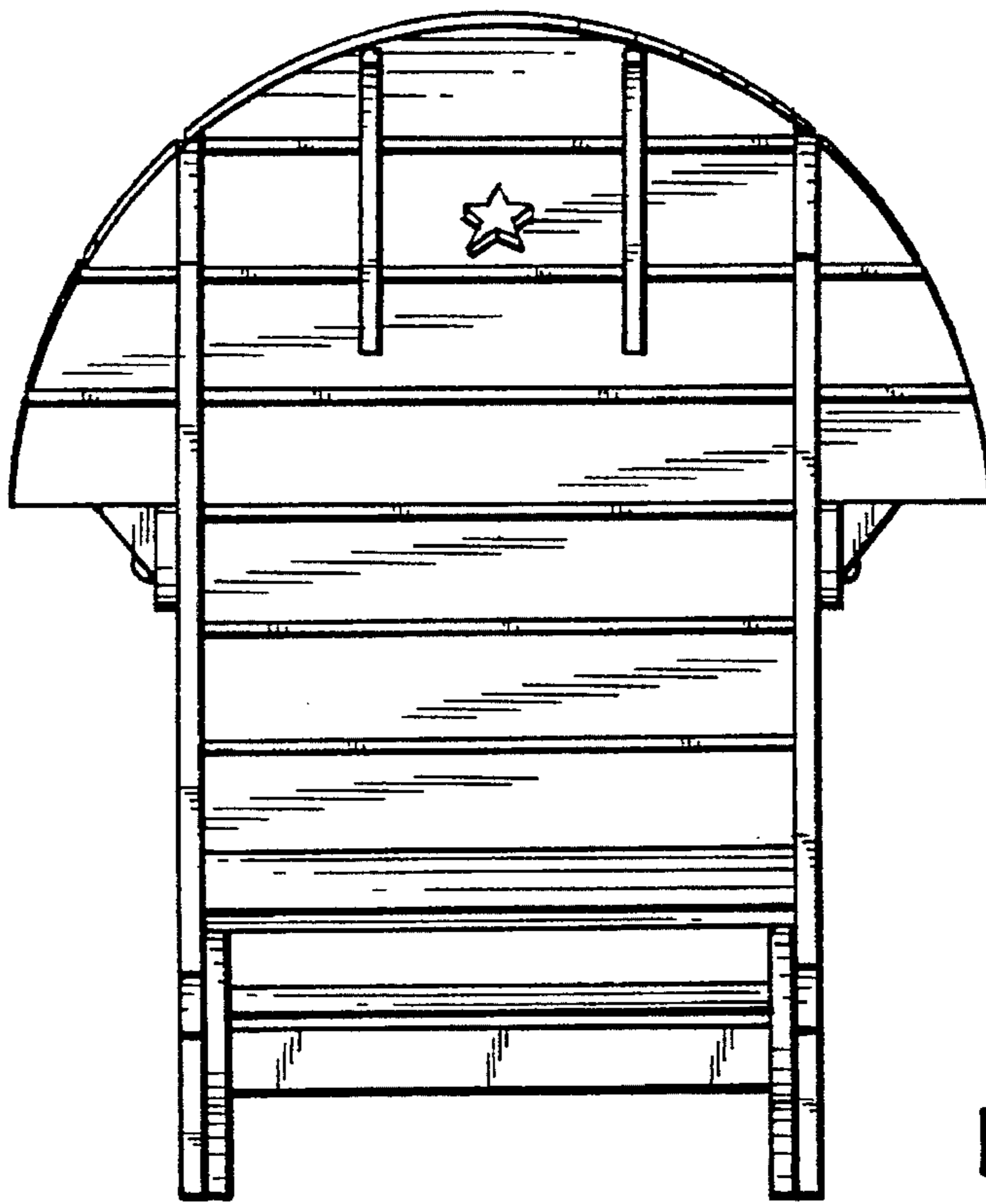

FIG. 5

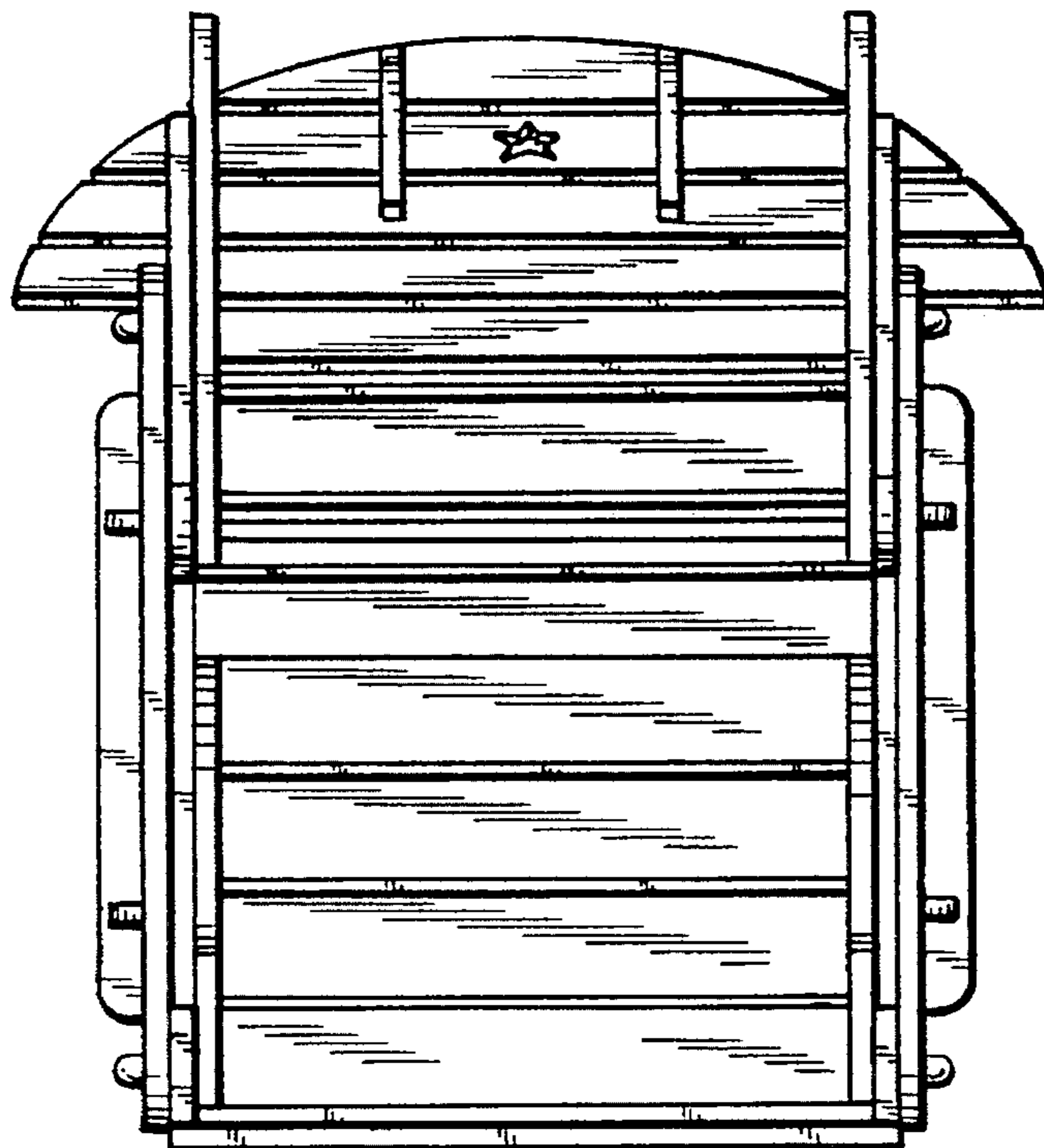

FIG. 6