



US00D371462S

United States Patent [19]

[11] Patent Number: **Des. 371,462**

Grossmith

[45] Date of Patent: ****Jul. 9, 1996**

[54] ELEVATABLE ERGONOMIC, INTERLOCKING FOOT REST

[76] Inventor: **Edward J. Grossmith**, 6503 Little Falls Dr., San Jose, Calif. 95120

[**] Term: **14 Years**

[21] Appl. No.: **35,643**

[22] Filed: **Mar. 3, 1995**

[52] U.S. Cl. **D6/349; D6/353**

[58] Field of Search D6/349-355; 297/423.1, 297/423.39, 423.41, 423.44, 423.45, 423.46, 461, 462

[56] References Cited

U.S. PATENT DOCUMENTS

D. 178,850	9/1956	Upson	D6/353
D. 186,488	10/1959	Madl	D6/350 X
D. 280,052	8/1985	Hypponen	D6/349
3,653,715	4/1972	Drabert et al.	297/423.45
4,441,758	4/1984	Fleischer et al.	297/423.46
4,549,767	10/1985	Hampshire et al.	297/423.46

Primary Examiner—Janice E. Seeger
Attorney, Agent, or Firm—William W. Burns

[57] CLAIM

The ornamental design for an elevatable ergonomic, interlocking foot rest, as shown and described.

DESCRIPTION

FIG. 1 is a perspective view of an elevatable, ergonomic, interlocking foot rest, showing my new design; showing the upper portion for convenience of illustration;

FIG. 2 is a side elevational view thereof;

FIG. 3 is a rear elevational view thereof;

FIG. 4 is a front elevational view thereof;

FIG. 5 is a top plan view thereof;

FIG. 6 is a bottom plan view thereof;

FIG. 7 is a perspective view, showing the lower portion for convenience of illustration;

FIG. 8 is a side elevational view thereof;

FIG. 9 is a front elevational view thereof;

FIG. 10 is a top plan view thereof;

FIG. 11 is a bottom plan view thereof;

FIG. 12 is a perspective view, showing the footrest in condition for use; and,

FIG. 13 is a side elevational view, the broken lines are for environmental purposes only and form no part of the claimed design.

1 Claim, 5 Drawing Sheets

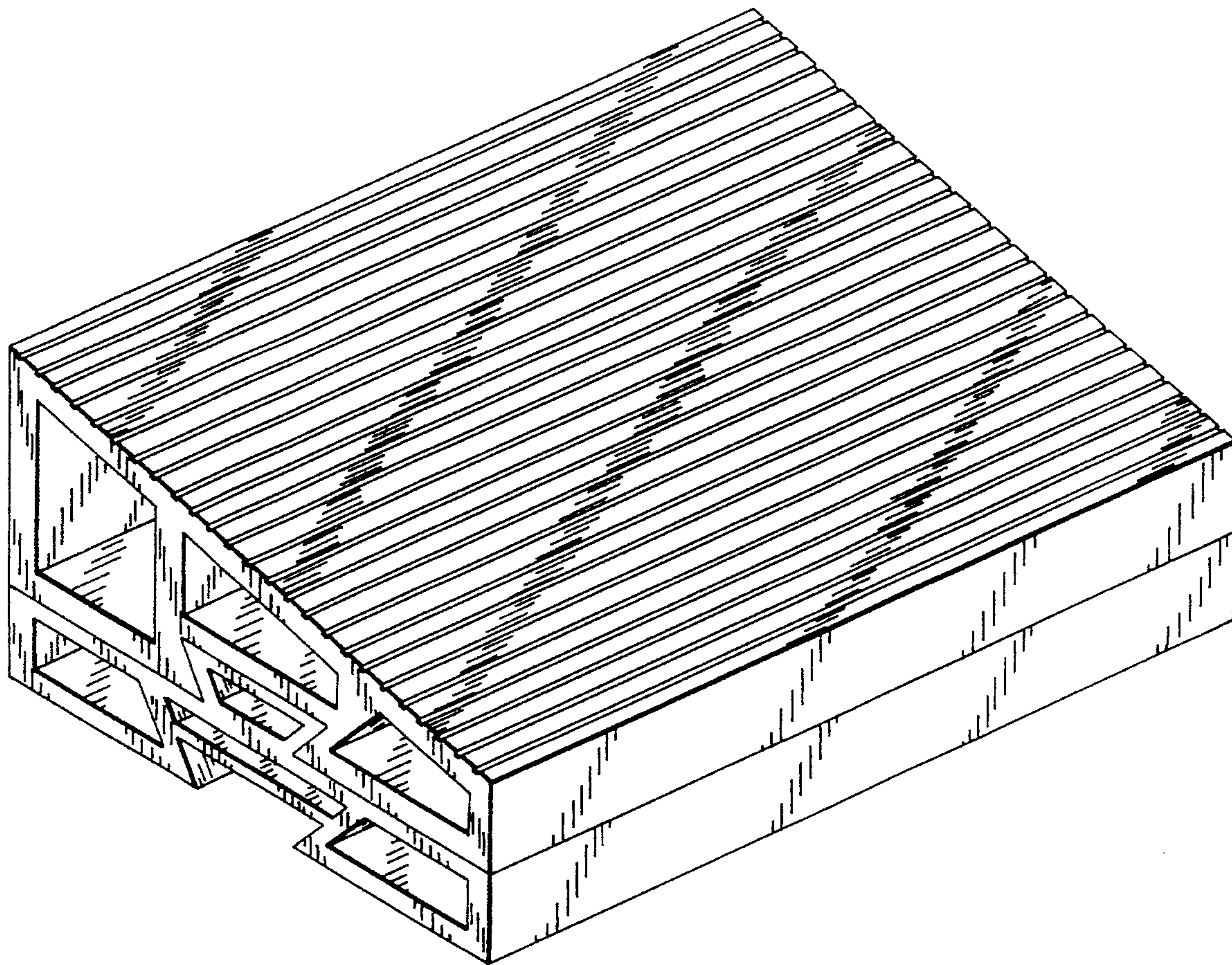

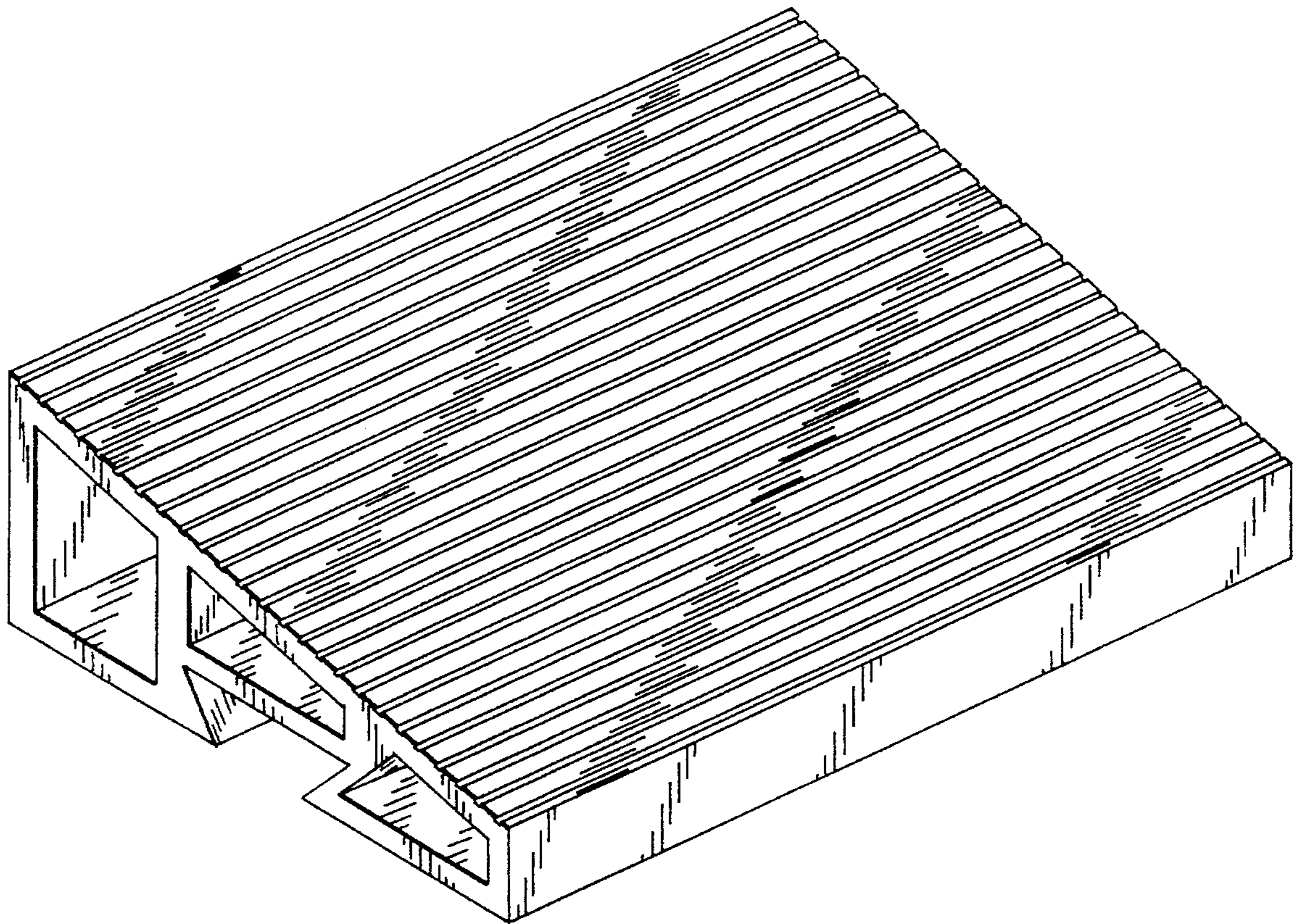

FIG. 1

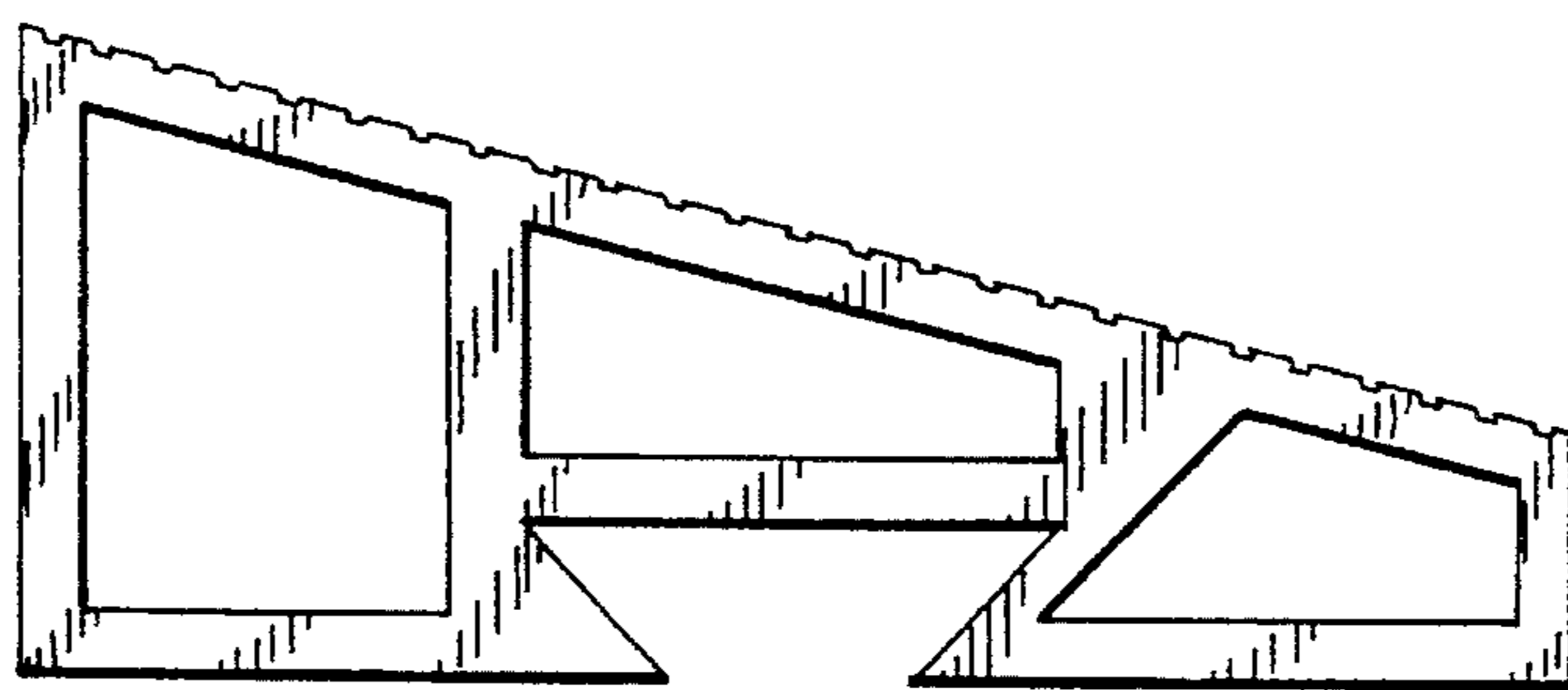

FIG. 2

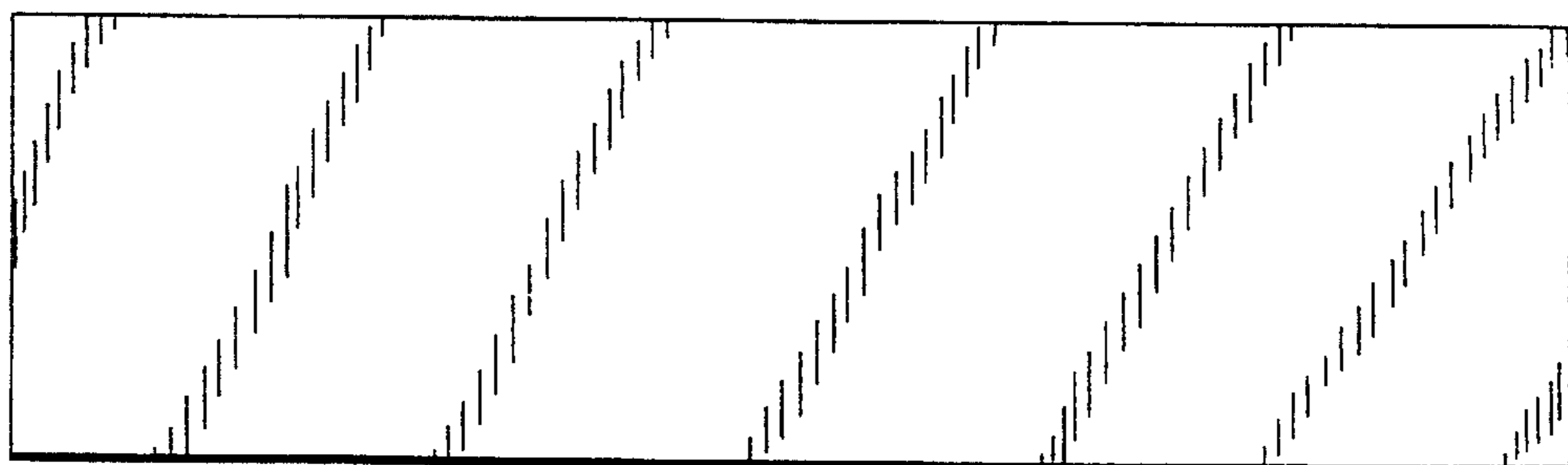

FIG. 3

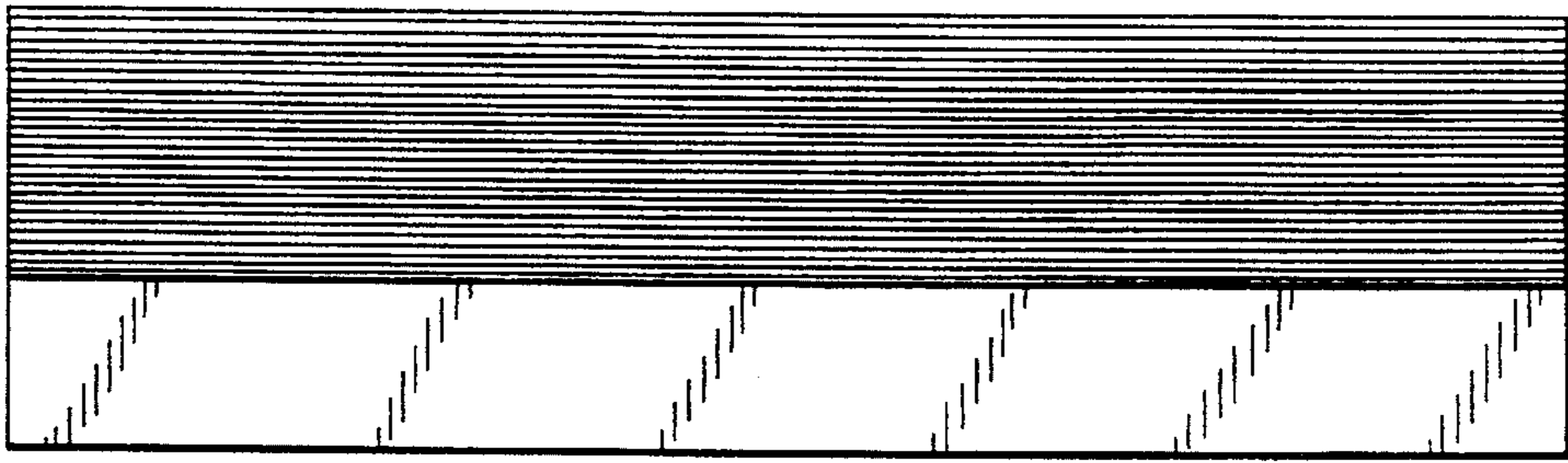

FIG. 4

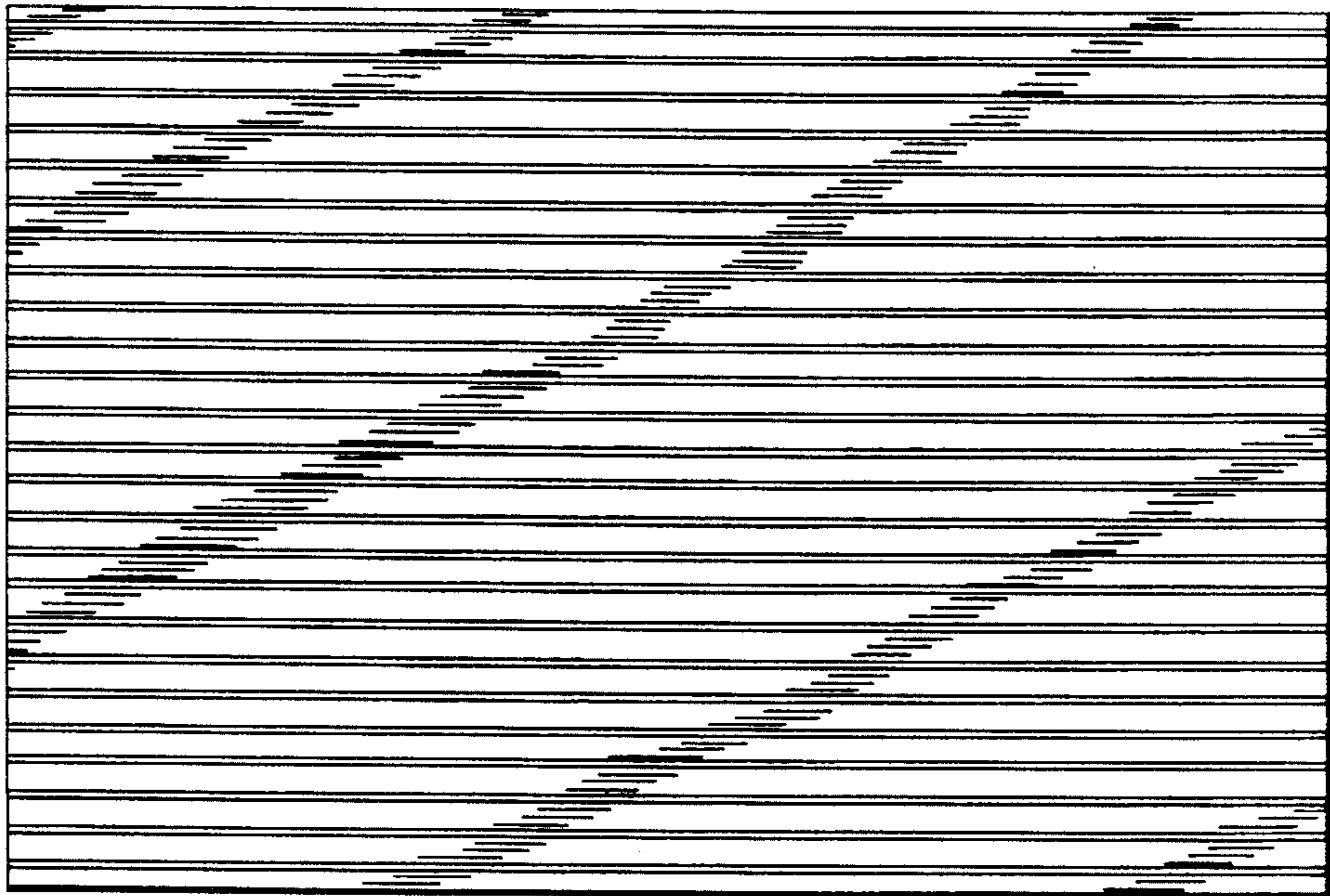

FIG. 5

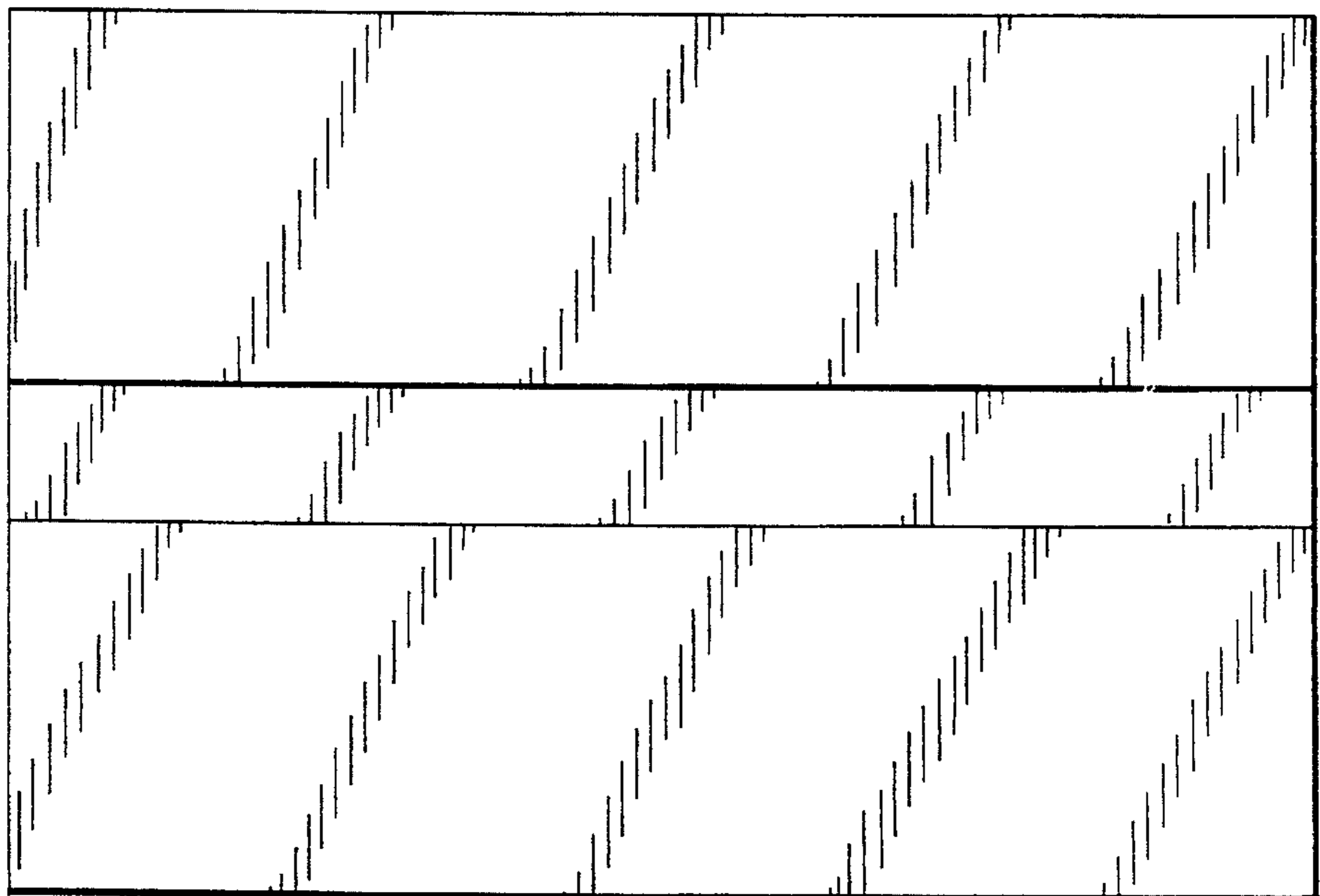

FIG. 6

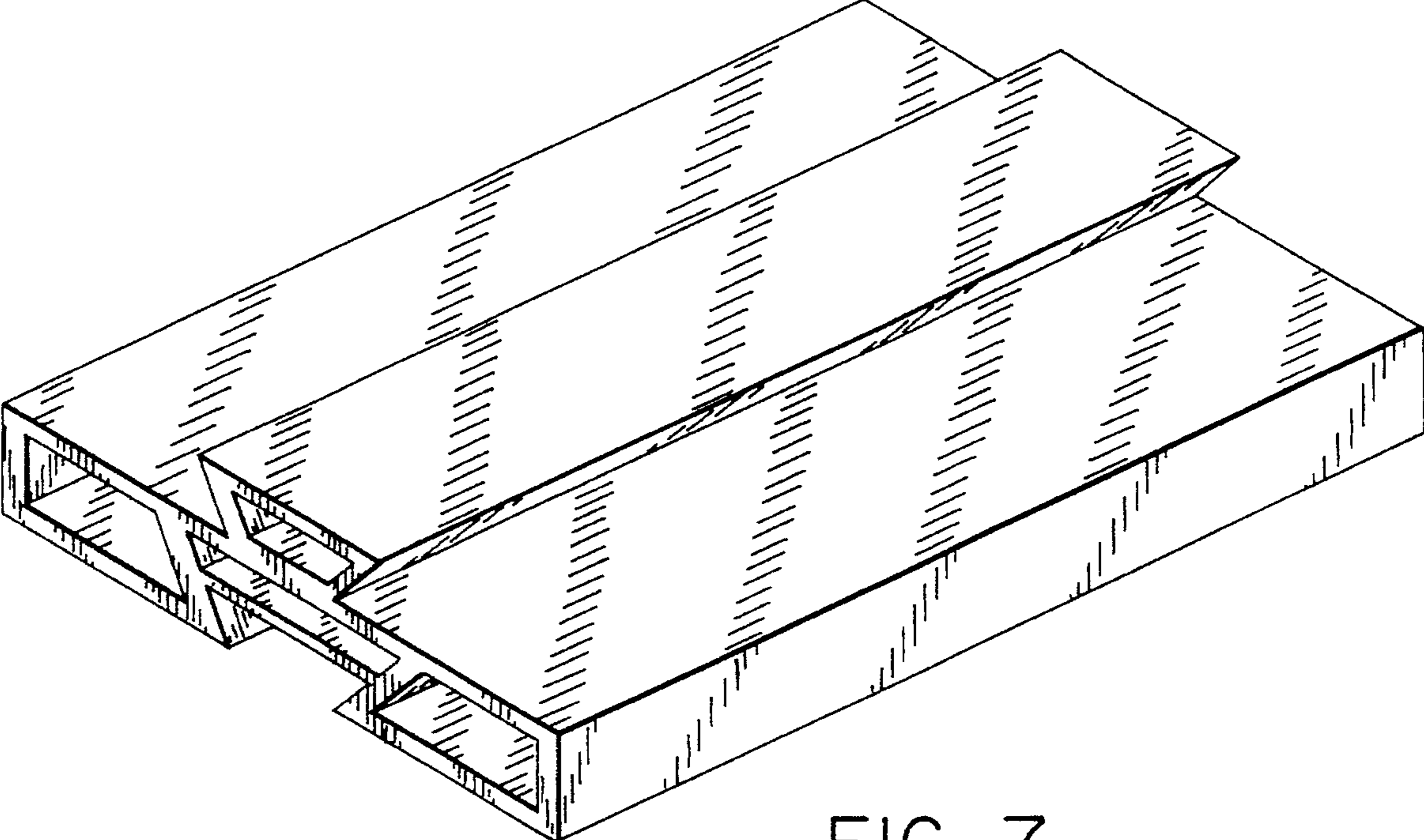

FIG. 7

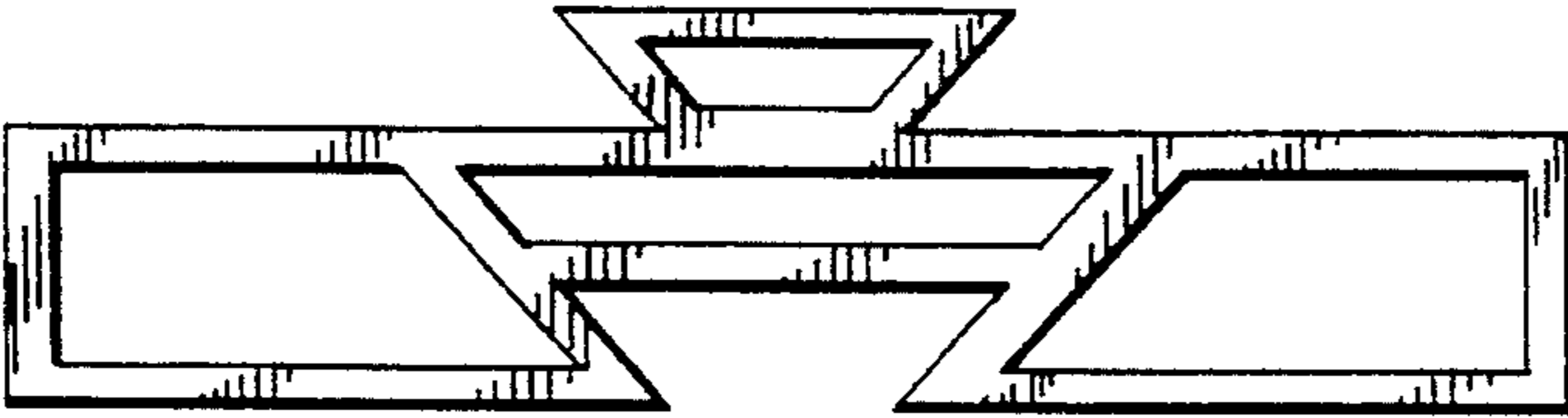

FIG. 8

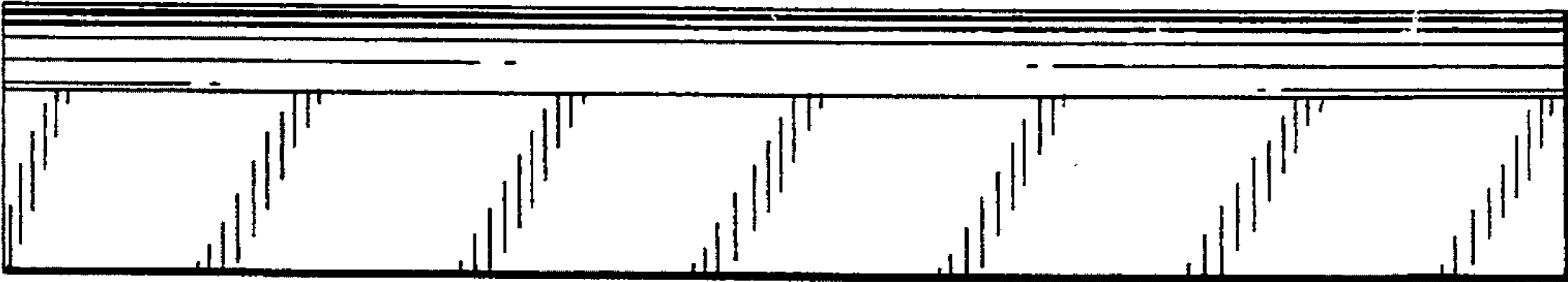

FIG. 9

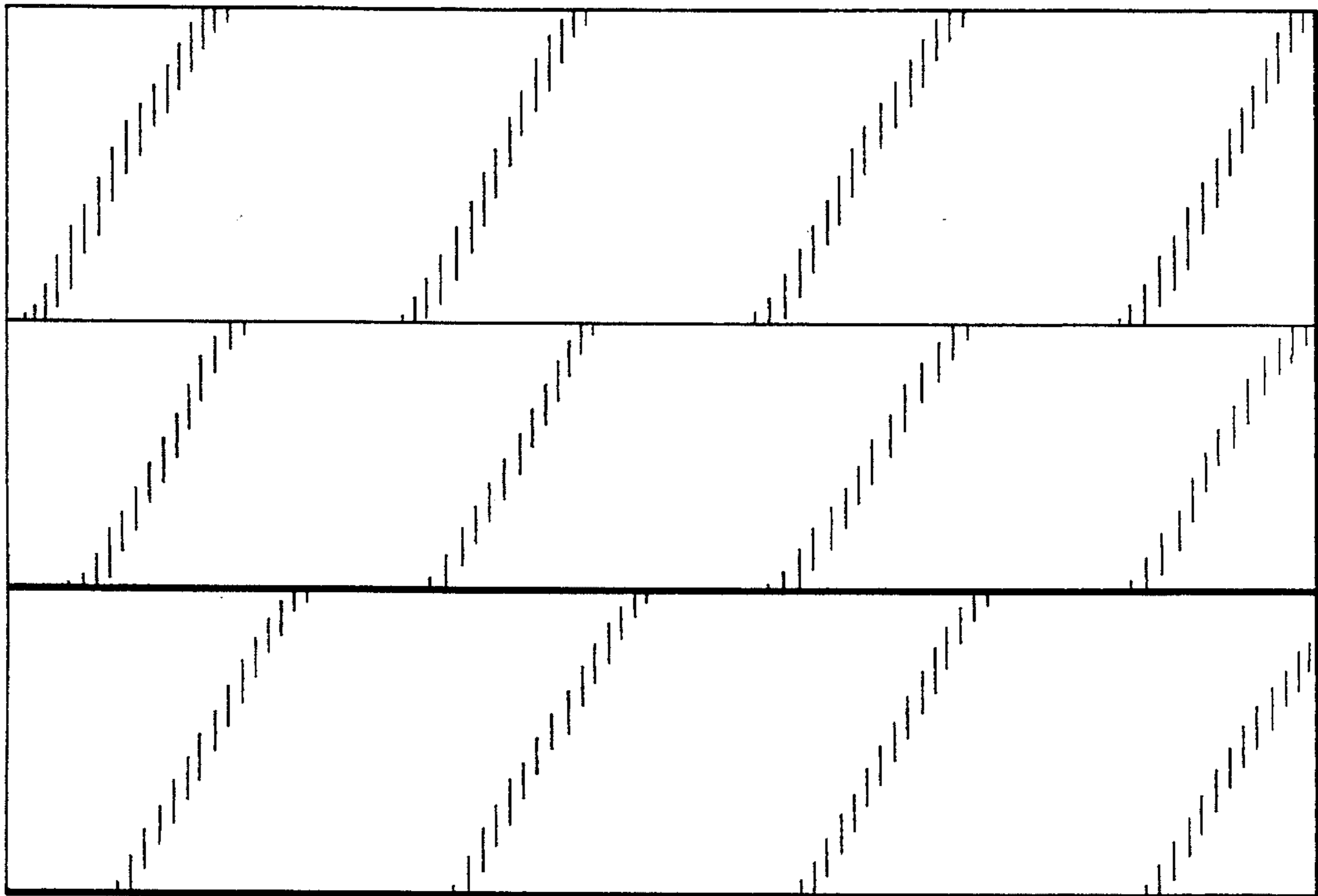

FIG. 10

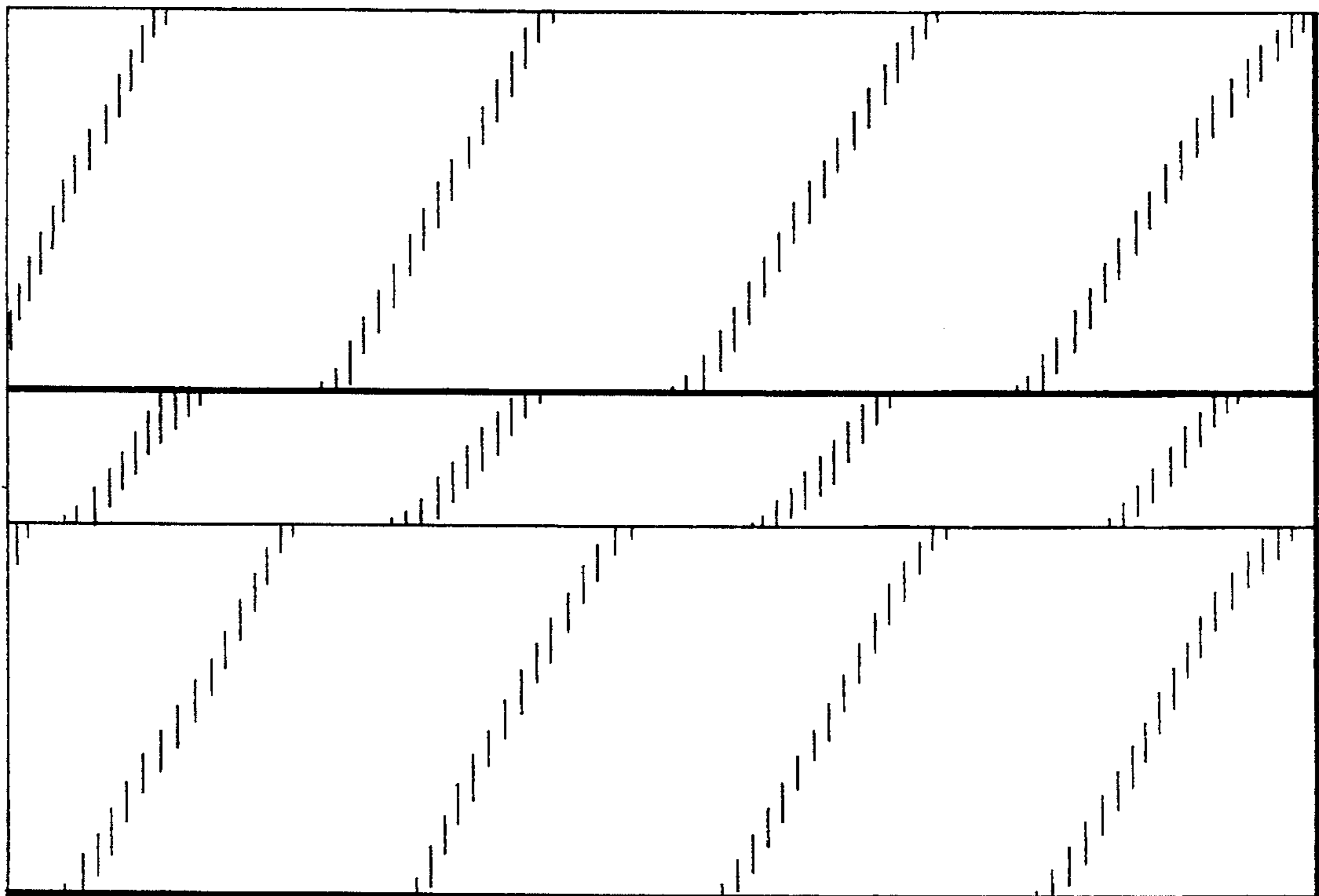

FIG. 11

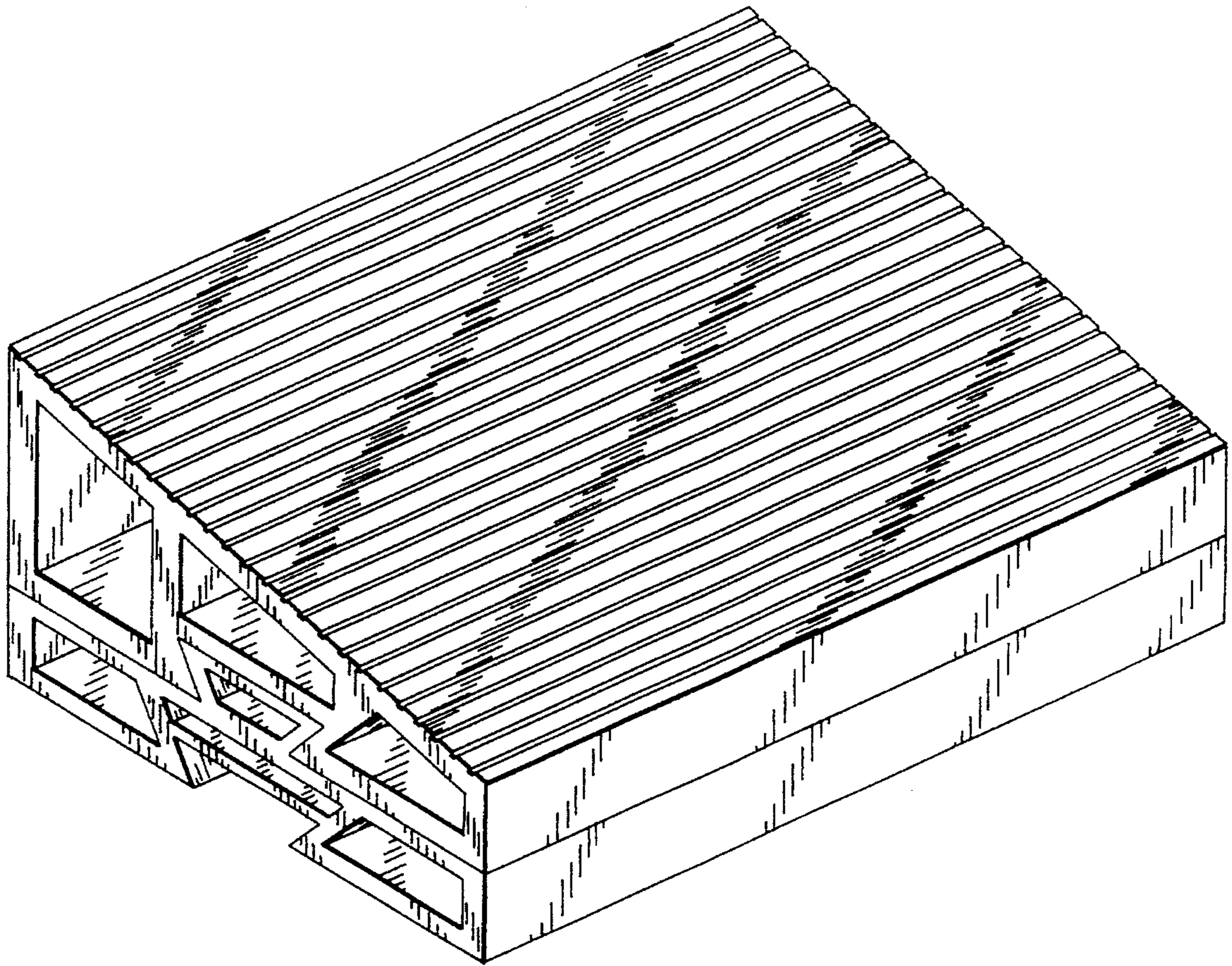

FIG. 12

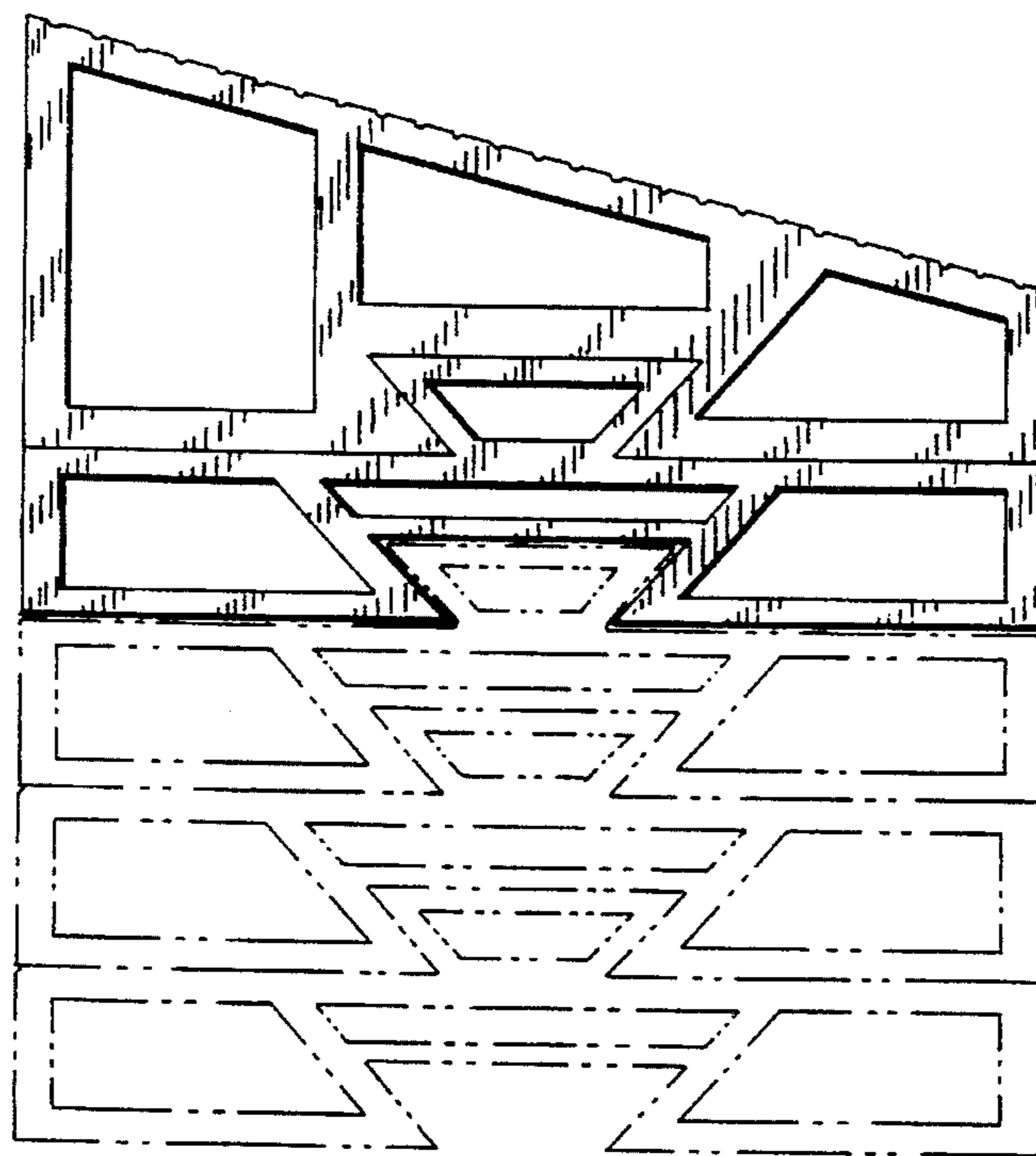

FIG. 13